

LCR Elite2

User Manual



Notices

The information contained in this document is provided “as is,” and is subject to change, without notice, in future editions.

This document contains proprietary information that is protected by copyright. All rights are reserved. No part of this document may be photocopied, reproduced, or translated to another language without the prior agreement and written consent from LCR Research Ltd.

© LCR Research Ltd. 2018

Warranty

LCR Research warrants this product to be free from defects in materials and workmanship for a period of one (1) year from the shipment date. During the warranty period, LCR Research will, at its option, either repair or replace products that prove to be defective. For warranty service or repair, this product must be returned to a service facility designated by LCR Research. The buyer shall prepay shipping charges to LCR Research, and LCR Research shall pay shipping charges to return the product to the buyer. However, the buyer shall pay all shipping charges, duties, and taxes for products returned to LCR Research from another country. Repaired or replaced products are warranted for the balance of the original warranty period.

Limitation of Warranty

This warranty does not cover normal wear and tear and scratches on surface or display. This warranty does not cover physical damage to the display, switch or button, electrical damage of the product due to high voltage or improper battery type. This warranty shall not apply to defects resulting from improper or inadequate maintenance by the buyer, buyer-supplied software or interfacing, unauthorized modification or misuse, operation outside the environmental specifications for the product, or improper site preparation or maintenance.

No other warranty is expressed or implied. LCR Research specifically disclaims the implied warranties of merchantability and fitness for a particular purpose. LCR Research shall not be liable for errors or for incidental or consequential damages in connection with the furnishing, use, or performance of this document or of any information contained herein.

Exclusive Remedies

The remedies provided herein are the Buyer’s sole and exclusive remedies. LCR Research shall not be liable for any direct, indirect, special, incidental, or consequential damages, whether based on contract, tort, or any other legal theory. Such excluded damages shall include, but are not limited to: costs of removal and installation, losses sustained as the result of injury to any person, or damage to property.

FCC Rules, Part 15.

This equipment has been tested and found to comply with the limits for a Class B digital device, pursuant to part 15 of the FCC Rules. These limits are designed to provide reasonable protection against harmful interference in a residential installation. This equipment generates, uses and can radiate radio frequency energy and, if not installed and used in accordance with the instructions, may cause harmful interference to radio communications. However, there is no guarantee that interference will not occur in a particular installation. If this equipment does cause harmful interference to radio or television reception, which can be determined by turning the equipment off and on, the user is encouraged to try to correct the interference by one or more of the following measures:

- Reorient or relocate the receiving antenna.
- Increase the separation between the equipment and receiver.
- Connect the equipment into an outlet on a circuit different from that to which the receiver is connected.
- Consult the dealer or an experienced radio/TV technician for help.

This device complies with Part 15 of the FCC rules.

Operation is subject to the following two conditions:

- This device may not cause harmful interference.
- This device must accept any interference received, including interference that may cause undesired operation.

Changes or modifications not expressly approved by the party responsible for compliance could void the user's authority to operate the equipment.

Safety Notices

CAUTION

Cautions must be observed to avoid minor injury to yourself or damage to the product or other property.

WARNING

Warnings must be followed carefully to avoid personal injury or death or damage to the product or other property.

Safety Considerations

Read the information below before using this meter. This meter is intended for use by qualified personnel who recognize shock hazards and are familiar with the safety precautions required to avoid possible injury. The following general safety precautions must be observed during all phases of operation, service, and repair of this meter. Failure to comply with these precautions or with specific warnings elsewhere in this manual violates safety standards for design, manufacture, and intended use of the meter. LCR Research assumes no liability for the customer's failure to comply with these requirements.

CAUTION

- Disconnect circuit power and discharge all high-voltage capacitors before testing.
- When measuring in-circuit components, first de-energize the circuits before connecting them to the test tips.
- The battery must be charged by a computer USB port or a USB power adapter that provides output voltage DC 5V \pm 5%.
- This meter is for indoor use.

WARNING

- **Use this meter only as specified in this manual, otherwise, the protection provided by the meter may be impaired.**
- **Do not use the meter if it is damaged. Before you use the meter, inspect the case. Look for cracks or missing plastic.**
- **Inspect the test tip sleeves for damaged insulation or exposed metal. Check the test tips for continuity. Replace damaged test tip sleeves before you use the meter.**
- **Do not touch exposed metal in measurement. Keep your fingers on insulated test tip sleeves.**
- **Do not use the meter if it operates abnormally.**
- **Do not operate the meter around explosive gas, vapor, or in wet environments.**
- **Never use the meter in wet conditions or when there is water on the surface. If the meter is wet, ensure that the meter is dried only by trained personnel.**
- **When servicing the meter, use only the specified replacement parts.**
- **Do not attempt to replace the internal lithium-ion polymer battery yourself. You may damage the battery, which could cause overheating and injury. The battery should be replaced only by a LCR Research Authorized Service Provider, and must be recycled or disposed of separately from household waste. Don't incinerate the battery.**
- **Do not use damaged cables or chargers, or charge when moisture is present. It can cause fire, electric shock, injury, or damage to the product or other property.**

Contents

1. Overview

Product Introduction	1
Features and Functions.....	1
The Navigation Button.....	1
Turn On the Meter	2
Power Off	2
Switching to Menu Screen from Measurement Screen.....	2
Charging the Battery.....	2
Battery Level Indicator	3
Display.....	4
Reset the Meter.....	5
Cleaning the Meter.....	5

2. Setting Up Menus

Menu Structure	6
Navigating Menus.....	7
Main Menu.....	7
Autoset	7
System Menu	8
Self-Calibration.....	8
Info Menu	10
Measurement Menu.....	10
LCR Menu.....	10
Secondary Parameter Menu	10
Test Frequency Menu.....	11
Circuit Mode Menu.....	11

3. Making Measurements

LCR Measurement.....	12
Auto Mode	13
Measuring Resistance (R).....	14
Measuring Inductance (L).....	14
Measuring Capacitance (C)	14
Selecting Secondary Parameters.....	15
Selecting Test Frequency.....	15
Selecting Circuit Mode.....	15
Protected by Aegis Technology.....	16

4. Characteristics and Specifications

Product Characteristics	17
Electrical Specifications.....	18
Testing Signal Specifications.....	18
Measurement Ranges and Optimal Testing Frequency	18
Over Voltage Protection Specifications.....	18
Resistance Accuracy Specifications.....	19
Inductance Accuracy Specifications	19
Capacitance Accuracy Specifications.....	20

Overview

This chapter provides the basic operation procedures and describes names and functions on the display.

Product Introduction

LCR Elite2 ("the meter") is a portable impedance measuring device for incoming inspection of components, quality control, and laboratory use.

It is capable of measuring resistance, capacitance or inductance with 4 test frequencies (100Hz, 120Hz, 1 kHz and 10kHz). It has a basic accuracy better than 0.2% for resistance, 0.2% for capacitance and 0.4% for inductance measurements.

The meter has a pair of gold plated tips that can pick the SMD components with size down to 0201 (0.6mm x 0.3mm). The parasitic parameters of its probes are small and very predictable thanks to its unique mechanical design. It significantly reduces the probability of measurement errors related to setup (such as wires, probes, tips).

Features and Functions

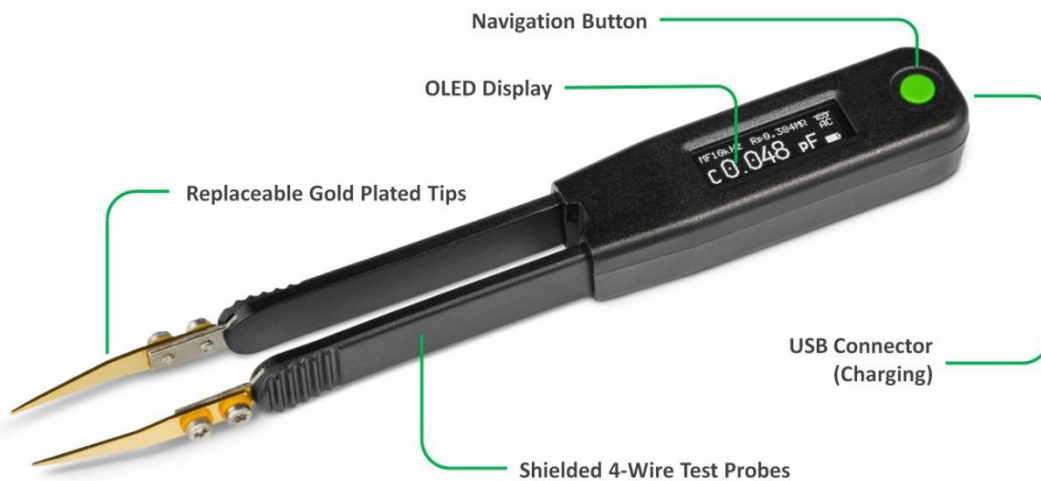

Figure 1-1: LCR Elite2 Overview

The Navigation Button

The navigation button is used to browse and select different functions and parameters as Figure 1-2 shows.



Figure 1-2: Navigation Button

The navigation button can be used for shortcut operation as well. Therefore, user can switch settings quickly in the measurement display and doesn't need to go back and forth between the menu display and measurement display. Detailed information is provided in Chapter 3: Making Measurements.

Turn On the Meter

To power on the meter, press the navigation button once. The meter powers up with the most recently selected measurement function.

Power Off

There are two ways to power off the meter:

1. Automatic power off. The meter powers off automatically if neither a measurement is performed nor any button is clicked for around 1 minute.
2. Manual power off by selecting the turn off option from main menu as Figure 1-3 shows.



Figure 1-3: Turning off Display

NOTE

If test frequency is manually set to 10kHz, automatic power off may take longer to occur or not occur at all. This is due to the meter being more sensitive at 10kHz. It may see parasitic values and keep measuring even when the tips are open.

Switching to Menu Screen from Measurement Screen

When the meter is in measurement mode, user can switch it to menu screen by holding the navigation button for half a second or so until the main menu screen shows up. Figure 1-4 shows the meter goes to main menu screen from active mode (measuring components). Figure 1-5 shows the meter goes to main menu screen from idle mode (not measuring any component in measurement mode).

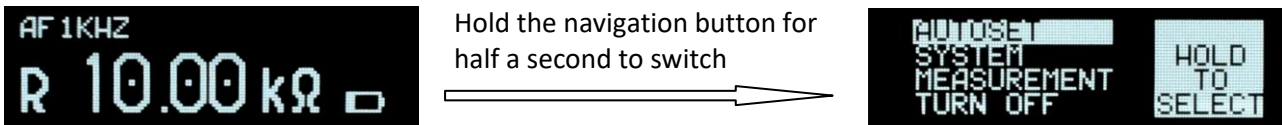

Figure 1-4: Switching from Measurement Display (in Active Mode) to Main Menu Display

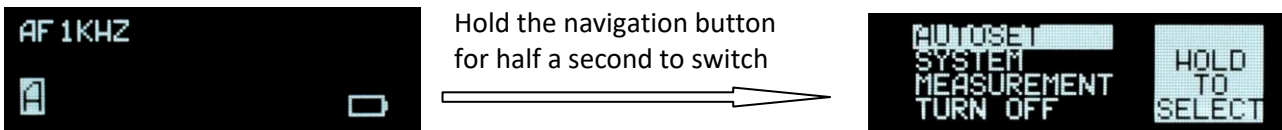

Figure 1-5: Switching from Measurement Display (in Idle Mode) to Main Menu Display

Charging the Battery

The meter is powered by an internal, lithium-ion polymer rechargeable battery. It can be charged by connecting to a computer USB port using a standard micro-B USB cable or, by using a USB power adapter. The USB power adapter should have output voltage 5V +/- 5% with output current 100mA or greater. The USB power adapter is available separately.

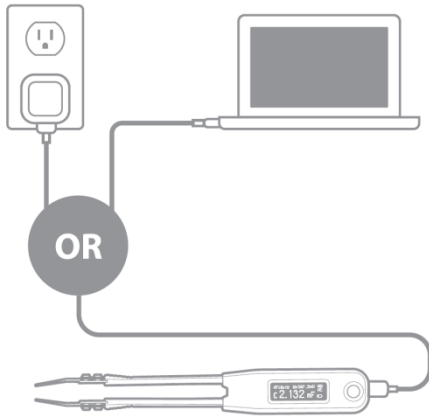

Figure 1-6: Charging the Meter

Battery Level Indicator

The battery icon in the bottom-right corner shows the battery level or charging status.

When the battery icon becomes hollow, it indicates that the battery remaining capacity is low and that it should be recharged. The warning appears when the battery capacity is about 95% depleted. The unit is still operational for a while, however the battery should be recharged as soon as possible.

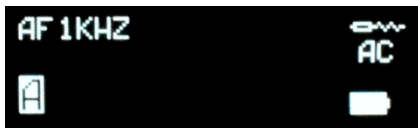

Figure 1-7: Full Battery Indicator

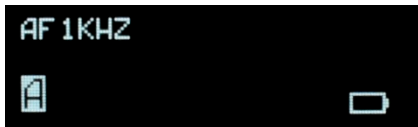

Figure 1-8: Empty Battery Indicator

When battery capacity is 100% depleted, the meter shows LOW BATTERY message on the display, then goes to sleep mode automatically.



Figure 1-9: Low Battery Message

CAUTION

Rechargeable batteries have a limited number of charge cycles and may eventually need to be replaced. The meter battery isn't user replaceable; it can be replaced only by a LCR Research Authorized Service Provider.

Display



This section describes the names and functions of parts on the meter display.



Figure 1-10: Measurement Display

The general display indicators of the meter are described in Table 1-1 below. Each display indicator is described. Please select the respective "Learn More On" page for more information on each indicator.

Table 1-1 General Display Indicators

Indicator	Description	Learn More On:
A	Auto mode indicator, the meter selects R, L C automatically according to the component under test.	Page 13
R	Resistance measurement indicator	Page 13
L	Inductance measurement indicator	Page 13
C	Capacitance measurement indicator	Page 13
AC	Auto circuit mode	Page 15
	Series circuit mode	Page 15
	Parallel circuit mode	Page 15
Rs	Series resistance indicator	Page 15
Rp	Parallel resistance indicator	Page 15
D	Dissipation factor indicator	Page 15
Q	Quality factor indicator	Page 15
AF	Auto select test frequency	Page 15
MF	Manual select test frequency	Page 15
100HZ	Test frequency at 100Hz	Page 15
120HZ	Test frequency at 120Hz	Page 15
1KHZ	Test frequency at 1kHz	Page 15
10KHZ	Test frequency at 10kHz	Page 15
	Battery capacity indicator	Page 3

The units listed below are applicable to the primary display measurements of the meter.

Table 1-2 Display of Measurement Units

Legend	Description
M	mega 1E+06 (1000000)
K	kilo 1E+03 (1000)
m	milli 1E-03 (0.001)
u	micro 1E-06 (0.000001)
n	nano 1E-09 (0.000000001)
p	pico 1E-12 (0.000000000001)
H	Henry, units for inductance measurement
F	Farad, units for capacitance measurement
Ω	Ohm, units for resistance and impedance measurement

Reset the Meter

The hardware reset function can reset the meter to factory original settings no matter which mode it is currently in. To perform hardware reset, just press down the navigation button for more than 10 seconds until the display shows LCR Research logo.

NOTE

After the meter is reset, all the self-calibration data will be removed. Please perform self-calibration again if necessary.

Cleaning the Meter

WARNING

To avoid electrical shock or damage to the meter, always keep the insides of the casing dry.

Dirt or moisture on the tips can affect measurement accuracy. Follow the steps below to clean the tips and case.

1. Shake out any dirt that may be on the tips.
2. Wipe the tips with a clean swab dipped in alcohol.
3. Wipe the case with a damp cloth and mild detergent.

NOTE

Do not use abrasives or solvents when cleaning the meter.

Setting Up Menus

This chapter describes how to set up menu items and parameters.

Menu Structure

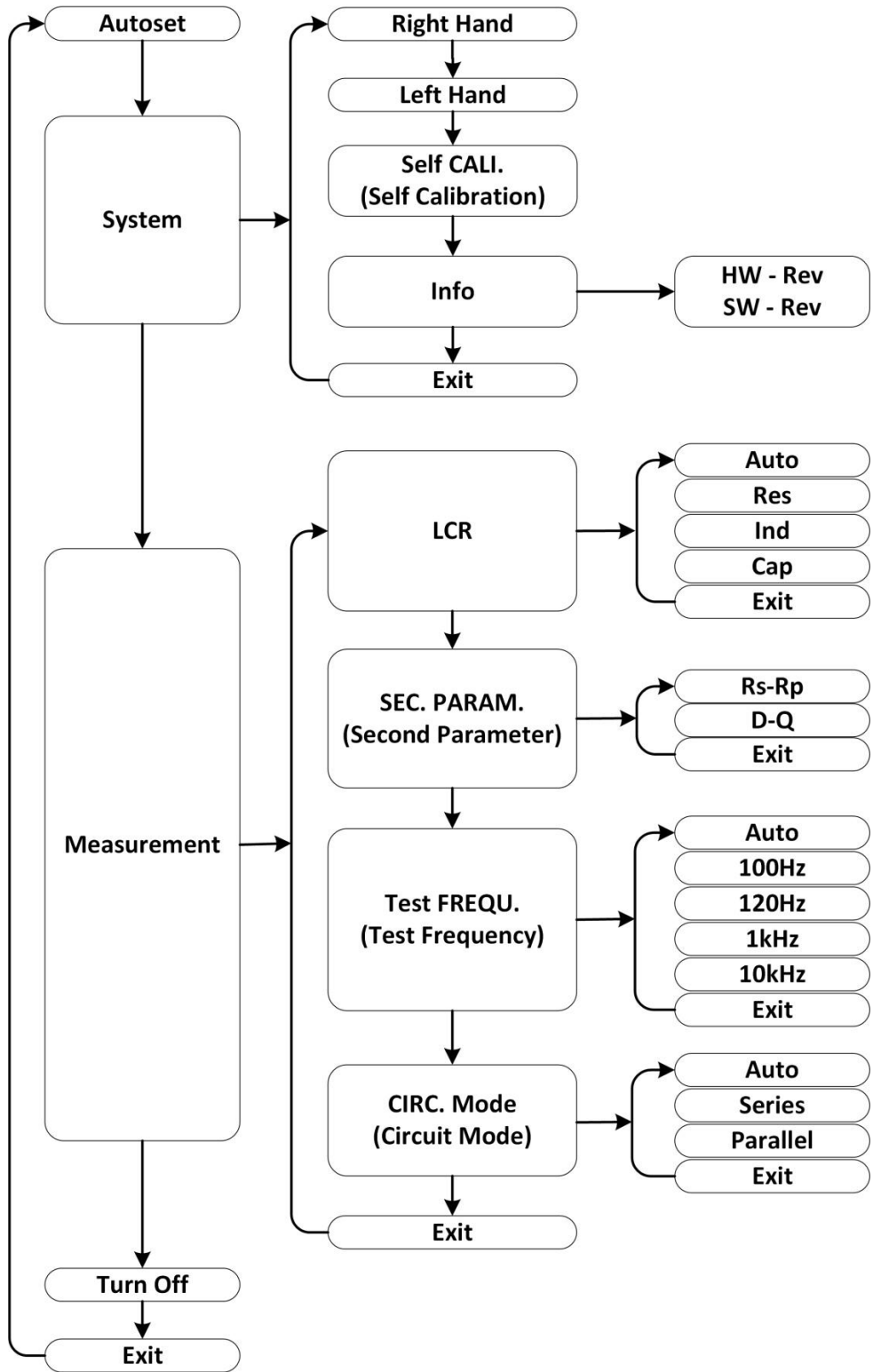

Figure 2-1: Menu Structure Flowchart

Navigating Menus

Single click the navigation button to move to the desired menu item and hold the button to select it. The highlighted item indicates the current setting.

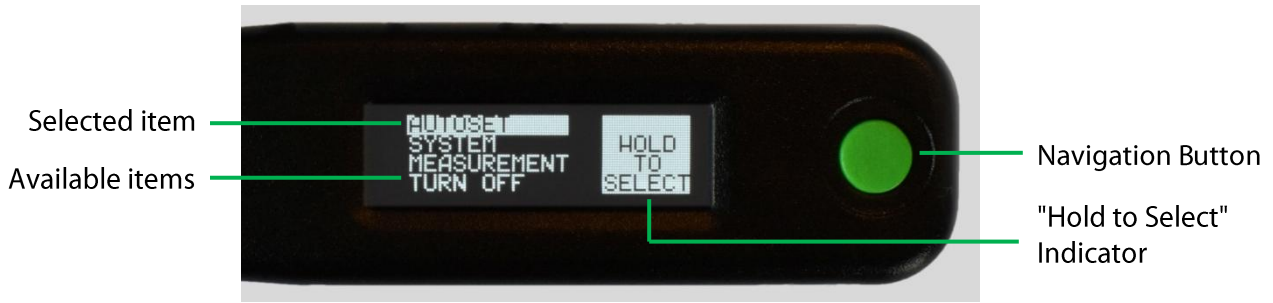

Figure 2-2: Navigating Menus

Main Menu

Main menu provides 5 options as described in Table 2-1.

Table 2-1 Description of Main Menu

Menu Item	Description	Learn More On:
Autoset	Reset all the settings to default	Page 7
System	Select user interface, start self-calibration and view device information	Page 8
Measurement	Select measurement types and test parameters	Page 10
Turn Off	Turn off the meter	Page 2
Exit	Return to the measurement display	



Figure 2-3: Main Menu

Autoset

Once Autoset is selected, the meter resets the following parameters to default:

- Measurement:
 - LCR: Auto
 - Secondary Parameters: Rs/Rp
- Test Parameters:
 - Test Frequency: Auto
 - Circuit Mode: Auto

System Menu

5 items can be selected in system menu as described in Table 2-2.

Table 2-2 Description of System Menu

Menu Item	Description	Learn More On:
Right Hand	Select the right hand operation mode	
Left Hand	Select the left hand operation mode	
Self CALI.	Start short and open calibration.	Page 8
Info	Provide the device information including serial number, hardware and software version.	Page 10
Exit	Return to the measurement display.	



Figure 2-4: System Menu

Self-Calibration

The self-calibration includes short and open calibration. It offsets the meter’s internal and external parasitic parameters for better accuracy. Performing this action will help the user correct the influence for temporary uses.

Table 2-3 describes how to set up the meter to self-calibration.

Table 2-3: Set Up Self-Calibration

Settings	Menu Structure
Self-Calibration	Main Menu -> System -> Self Cali.

In self-calibration mode, the step by step instructions are shown on the display. Follow these instructions to perform the short/open calibration:

1. When self-calibration is selected, Figure 2-5 shows on the display. Please shorten 2 tips and press the navigation button to start the short calibration.



Figure 2-5: Start Short Calibration

2. Once the navigation button is pressed, Figure 2-6 shows on the display indicating short calibration is in progress.

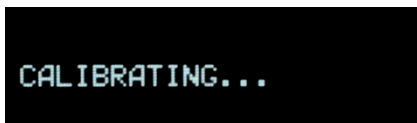

Figure 2-6: Calibration in Progress

3. After a couple of seconds, the short calibration is completed. Figure 2-7 shows on the display. Please keep the tips open and press the navigation button to start the open calibration.



Figure 2-7: Start Open Calibration

4. Once the navigation button is pressed, Figure 2-8 shows on the display indicating open calibration is in progress.

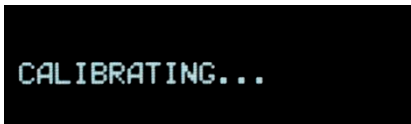

Figure 2-8: Calibration in Progress

5. After a couple of seconds, the open calibration is completed. If the result is good, a calibration done message will be on the display as Figure 2-9 shows. It indicates the whole self-calibration process is completed. Such message stays on the display for 1 second or so, then the meter will automatically return to the measurement screen.



Figure 2-9: Calibration Completed

6. If the result is out of range, a fail message will be on the display as Figure 2-10 shows. Then the meter will automatically return to the measurement screen. If necessary, please start the self-calibration process again from the beginning.

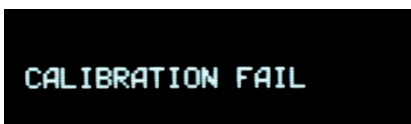

Figure 2-10: Calibration Failed

NOTE

- (1) It is recommended that the user performs open/short calibration before making precision measurements.
- (2) When doing short calibration, please always keep the tips shorted firmly. The calibration process may fail if the tips are in poor contact condition during the short calibration process.
- (3) The distance between the tips creates small parasitic capacitance. When such distance varies (i.e. measuring components with different sizes), the parasitic capacitance varies as well. Therefore, when doing open calibration, please keep the tip distance as close as possible to the actual size of the component to be measured. It can compensate for the parasitic capacitance most accurately.
- (4) After the battery is completely dead or hardware reset is performed, all the self-calibration data will be removed. Please perform self-calibration again if necessary.

Info Menu

The following device information has been provided in the Info menu:

- HW Version: it provides the device hardware version.
- SW Version: it provides the device software version.



Figure 2-11: Info Menu

Measurement Menu

5 items can be selected in Measurement menu as described in Table 2-4.

Table 2-4 Description of Measurement Menu

Menu Item	Description	Learn More On:
LCR	Measure inductance (L), capacitance (C) or resistance (R)	Page 10 , Page 12
SEC. PARAM.	Select the secondary parameter to be displayed.	Page 10 , Page 15
Test FREQU.	Set the frequency of the test signal.	Page 11 , Page 15
CIRC. Mode	Set the circuit mode.	Page 11 , Page 15
Exit	Return to the measurement display	



Figure 2-12: Measurement Menu

LCR Menu

The following settings can be selected in LCRZ menu and the default setting is Auto.

- Auto: the meter automatically identifies the component under test (L, C or R).
- R: measure resistance.
- L: measure inductance.
- C: measure capacitance.
- Exit: Return to the measurement display.



Figure 2-13: LCR Menu

Secondary Parameter Menu

The following settings can be selected in Secondary Parameter menu and the default setting is Rs-Rp.

- Rs-Rp: the meter displays series resistance (Rs) or parallel resistance (Rp). If the circuit mode is selected as series, Rs will be displayed. If the circuit mode is selected as parallel, Rp will be displayed.
- D-Q: the meter displays dissipation factor (D) or quality factor (Q). If a capacitor is being measured, D will be displayed. If an inductor is being measured, Q will be displayed.

- Exit: Return to the measurement display.

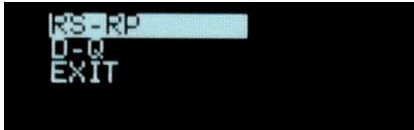

Figure 2-14: Secondary Parameter Menu

Test Frequency Menu

Test Frequency menu is used to set the frequency of the test signal. The default setting is Auto and the following settings can be selected:

- Auto: auto frequency (AF) mode, the meter automatically selects the best test frequency.
- 100Hz: set test frequency to 100Hz.
- 120Hz: set test frequency to 120Hz.
- 1kHz: set test frequency to 1kHz.
- 10kHz: set test frequency to 10kHz.
- Exit: Return to the measurement display.



Figure 2-15: Test Frequency Menu

Circuit Mode Menu

Circuit Mode menu is used to set the secondary parameters on the display. The default setting is Auto and the following settings can be selected:

- Auto: set to auto circuit mode. Series or parallel circuit mode will be automatically identified.
- Series: set to series circuit mode.
- Parallel: set to parallel circuit mode.
- Exit: Return to the measurement display.



Figure 2-16: Circuit Mode Menu

Making Measurements

This chapter describes how to select a measurement type, set parameters, perform measurements and get the results of the component under test.

WARNING

To avoid electrical hazards and possible damage to the meter or to the equipment under test, always discharge the capacitor to be tested before measuring. For in circuit measurement, always disconnect circuit power and discharge all high-voltage capacitors before testing.

NOTE

When doing in circuit testing, the test result may be affected by other components that connect to the component under test. The component under test may need to be isolated from other components in order to get accurate result.

LCR Measurement

LCR measurement includes auto mode (Auto), resistance measurement (R), inductance measurement (L), and capacitance measurement (C).

Figure 3-1 shows a typical display in LCR measurement. It shows test frequency and test voltage on the top. The primary display is in the middle showing component type and measurement result. The secondary parameter reading is shown underneath the primary display. The circuit mode, sound icon and battery indicator are displayed on the bottom.

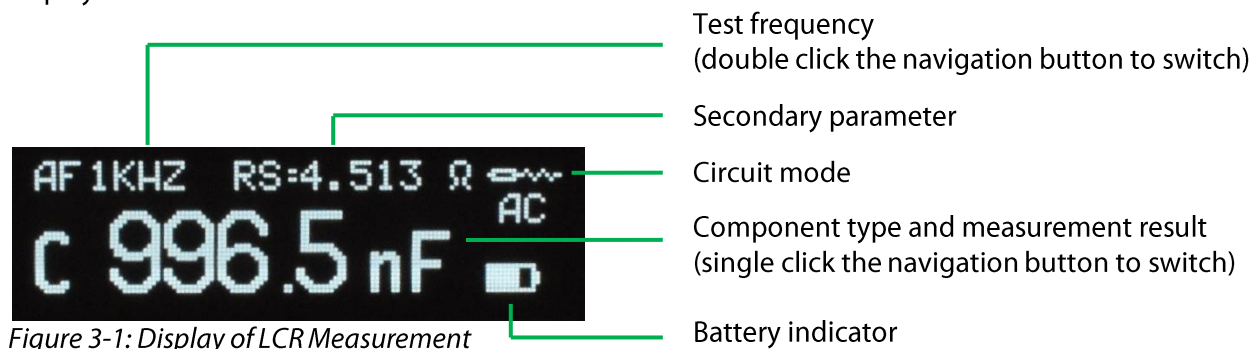

Figure 3-1: Display of LCR Measurement

Shortcuts are provided to quickly select the settings. Below are the available shortcuts in LCR measurement:

- Single click the navigation button to switch component type as Figure 3-2 shows.
- Double click the navigation button to switch test voltage as Figure 3-3 shows.

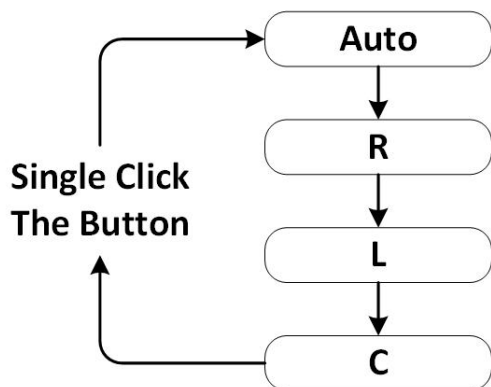

Figure 3-2: Switch Component Type by Single Clicking the Navigation Button

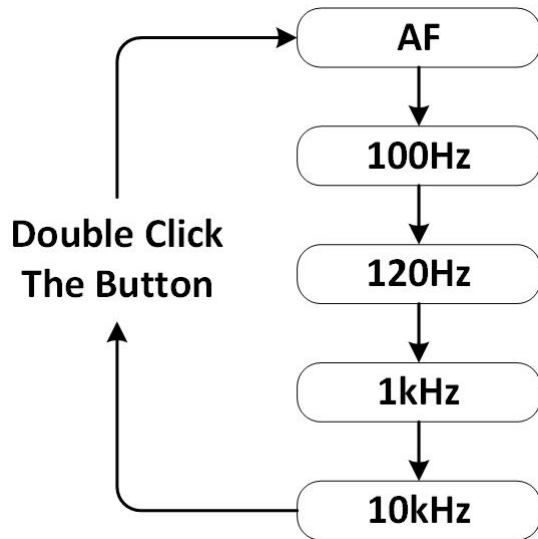

Figure 3-3: Switch Test Frequency by Double Clicking the Navigation Button

Auto Mode

In auto mode, the meter identifies resistance (R), inductance (L) and capacitance (C) automatically.

Table 3-1 describes how to set up the meter to auto mode.

Table 3-1: Set Up Auto Mode

Settings	Menu Structure
Auto	Main Menu -> Measurement -> LCR -> Auto

In auto mode, the meter identifies L, C, and R according to the angle of impedance detected in the component under test. Table 3-2 lists the phase angle rules.

Table 3-2 Auto Mode Phase Angle Rules

Phase Angle Setting	Primary Display
$ Q < 5^\circ$ phase angle	R
$Q \geq +5^\circ$ phase angle	L
$Q \leq -5^\circ$ phase angle	C

NOTE

- (1) When auto mode is selected, the testing frequency and secondary parameter stay unchanged. To change them separately, please refer page 15: [Selecting Circuit Mode](#) and page 15: [Selecting Test Frequency](#).
- (2) The autoset option in main menu can be used to reset the meter to the default mode (auto mode with auto testing frequency and auto circuit mode). Please refer page 7: [Autoset](#) to know which settings will be reset when autoset is selected.

Measuring Resistance (R)

Table 3-3 describes how to set up the meter to resistance measurement.

Table 3-3: Set Up Resistance Measurement

Settings	Menu Structure
R	Main Menu -> Measurement -> LCR -> R

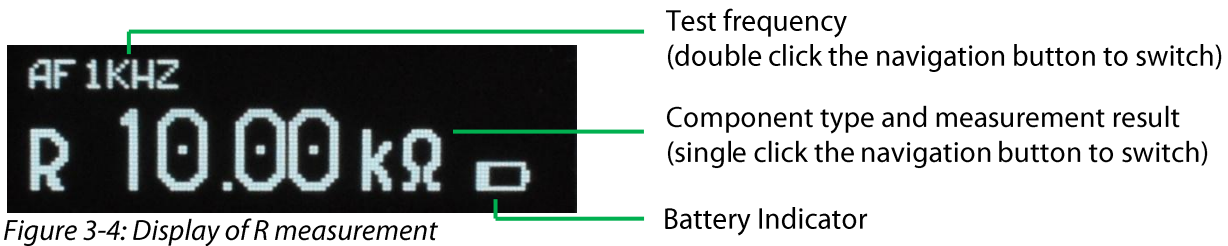

Figure 3-4: Display of R measurement

Measuring Inductance (L)

Table 3-4 describes how to set up the meter to inductance measurement.

Table 3-4: Set Up Inductance Measurement

Settings	Menu Structure
L	Main Menu -> Measurement -> LCR -> L

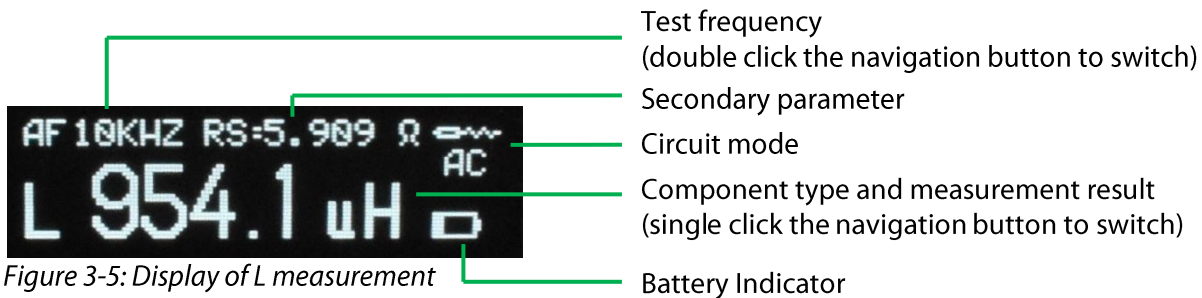

Figure 3-5: Display of L measurement

Measuring Capacitance (C)

Table 3-5 describes how to set up the meter to capacitance measurement.

Table 3-5: Set Up Capacitance Measurement

Settings	Menu Structure
C	Main Menu -> Measurement -> LCR -> C

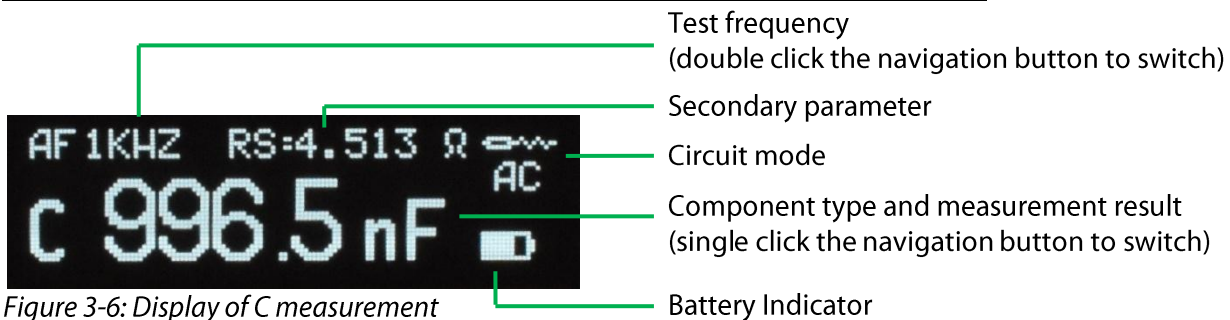

Figure 3-6: Display of C measurement

Selecting Secondary Parameters

Table 3-6 describes how to set up secondary parameters from the main menu.

Table 3-6: Set Up Secondary Parameter

Settings	Available Options	Menu Structure	Learn More On:
Secondary Parameters	Rs-Rp, D-Q	Main Menu -> Measurement -> SEC. PARAM.	Page 10

If resistance mode (Rs-Rp) is selected, the meter shows Rs when circuit mode is selected as series and shows Rp when circuit mode is selected as parallel. If dissipation or quality factor mode (D-Q) is selected, the meter shows D when measuring capacitance and shows Q when measuring inductance.

Selecting Test Frequency

Table 3-7 describes how to set up test frequency from the main menu.

Table 3-7: Set Up Test Frequency

Settings	Available Options	Menu Structure	Learn More On:
Test Frequency	Auto, 100Hz, 120Hz, 1kHz, 10kHz	Main Menu -> Test PARAM. -> Test FREQU.	Page 11

NOTE

The meter is able to use auto frequency to measure capacitance approximately from 3 pF to 199 μ F and inductance approximately from 1uH to 100mH. To measure capacitance or inductance out of this range, please select proper testing frequency manually according to [Table 4-3: Measurement Ranges and Optimal Testing Frequency](#).

Selecting Circuit Mode

Table 3-8 describes how to set up circuit mode from the main menu.

Table 3-8: Set Up Circuit Mode

Settings	Available Options	Menu Structure	Learn More On:
Circuit Mode	Auto, Series, Parallel	Main Menu -> Test PARAM. -> CIRC. Mode	Page 11

If auto mode is selected, series circuit mode or parallel circuit mode will be automatically identified. See Table 3-9 for the series/parallel rules used.

Table 3-9 Auto Mode Series/Parallel Rules

Range of Component Under Test	Circuit Mode Selected in Auto Mode
$C < 400 \text{ pF}$	Parallel Circuit Mode
$C \geq 400 \text{ pF}$	Series Circuit Mode
L	Always Series Circuit Mode

Protected by Aegis Technology

The Aegis Technology is our patent pending solution that automatically protect the meter from being damaged by energized components.

The traditional LCR meters have a common vulnerability to high voltage and current from the component they are measuring. In many cases, the component under testing can have stored energy, for example a charged capacitor or a powered on board. The energy in the component is a common problem that causes damage to LCR meters, thus requiring expensive and time-consuming repairs.

The Aegis Technology solves this problem. It provides over voltage protection up to +/-48Vdc (or +/-34Vac). In normal operation, it is transparent and doesn't affect the measurement results thanks to the low parasitic design. When an abnormal voltage is applied on the device's test tips, no matter positive or negative, the Aegis Technology detects it right away and automatically disconnects it from the meter.

When the meter is in over voltage protection mode, the "OVER VOLT" message is displayed as Figure 3-7 shows. To return to normal operation mode, please remove the meter from the component and press the navigation button. No components are damaged and no fuse replacement is required.



Figure 3-7: Over Voltage Display

Characteristics and Specifications

Product Characteristics

Table 4-1 Product Characteristics

Dimensions (L x W x H)	151 x 19 x 14.5mm
Weight	30 grams
Display	0.91-inch, 128x32 OLED display
Battery	3.7V, 180 mAH internal lithium-ion polymer battery
Battery Life	1 day in typical measurement ⁽¹⁾
Charging Source	USB port USB power adapter (output voltage DC 5V ± 5%)
Charging Rate	75mA ± 10%
Charging Time	2.5 hours (typical)
Measurement Speed	1sec (typical)
Operating Environment	Operating temperature from -10°C to 50°C, 0% to 80% RH Full accuracy up to 80% RH for temperature 23°C ± 3°C
Storage Compliance	-20°C to 60°C, 0% to 80% RH
Safety and EMC Compliance	FCC15/EN 55011/ICES-003 - Class B, Radiated Emissions FCC15/ICES-003 - Class B, Conducted Emissions EN 55011: Mains Terminal Disturbance Voltage, Class B EN 61000-3-2: Harmonics Current Emissions, Class A EN 61000-3-3: Voltage Fluctuations and Flicker EN 61000-4-2: ESD (4 kV Contact, 8 kV Air) EN 61000-4-3: Electromagnetic Field EN61000-4-4: Burst EN61000-4-5: Surge EN61000-4-6: Conducted RF EN61000-4-11: Voltage Dips EN61000-4-11: Short Interruptions
Calibration Cycle	1 Year (Recommended)

NOTE

Battery life varies by use, configuration, and many other factors. Actual results may vary.

Electrical Specifications

Testing Signal Specifications

Table 4-2 Testing Signal Specifications

Testing Frequency	100Hz, 120Hz, 1kHz, 10kHz
Testing Frequency Accuracy	50 ppm (0.005%)
Testing Signal Level	0.5Vrms, +/- 5% sine wave
Source Impedance	100Ω ± 1%

Measurement Ranges and Optimal Testing Frequency

Table 4-3 Measurement Ranges and Optimal Testing Frequency

Parameter	Measurement range	Optimal testing frequency
Resistance	20mΩ to 10MΩ	1kHz
Capacitance	0.1pF to 40nF	10kHz
	40nF to 40uF	1kHz
	40uF to 5mF	100Hz
Inductance	100nH to 1mH	10kHz
	1mH to 100mH	1kHz
	100mH to 1H	100Hz

Over Voltage Protection Specifications

Table 4-4 Over Voltage Protection

Maximum Range	Conditions
± 48Vdc (or ± 34Vac sine wave)	The voltage is applied between two test tips.

Resistance Accuracy Specifications

Table 4-5 LCR Elite2 Resistance Accuracy Specification

Range	Resolution	Accuracy = $A_z + \text{Offset}$			
		100Hz	120Hz	1kHz	10kHz
1000m Ω	0.01m Ω	0.5% + 20m Ω	0.5% + 20m Ω	0.5% + 20m Ω	0.5% + 20m Ω
10 Ω	0.0001 Ω	0.5% + 0.02 Ω	0.5% + 0.02 Ω	0.5% + 0.02 Ω	0.5% + 0.02 Ω
100 Ω	0.001 Ω	0.3% + 0.03 Ω	0.3% + 0.03 Ω	0.3% + 0.03 Ω	0.3% + 0.03 Ω
1000 Ω	0.01 Ω	0.3% + 0.3 Ω	0.3% + 0.3 Ω	0.3% + 0.3 Ω	0.3% + 0.3 Ω
10k Ω	0.0001k Ω	0.3% + 0.003k Ω	0.3% + 0.003k Ω	0.2% + 0.003k Ω	0.3% + 0.003k Ω
100k Ω	0.001k Ω	0.3% + 0.05k Ω	0.3% + 0.05k Ω	0.2% + 0.05k Ω	0.3% + 0.05k Ω
1000k Ω	0.01k Ω	1.0% + 0.5k Ω	1.0% + 0.5k Ω	0.3% + 0.5k Ω	1.0% + 0.5k Ω
10M Ω	0.0001M Ω	2.5% + 0.008M Ω	2.5% + 0.008M Ω	2.5% + 0.008M Ω	---

NOTE

The measurements are performed with necessary open and short calibration done prior to verifying the meter's accuracy.

Inductance Accuracy Specifications

Table 4-6 LCR Elite2 Inductance Accuracy Specifications

Range	Resolution	Accuracy = $A_L + \text{Offset}$			
		100Hz	120Hz	1kHz	10kHz
1000nH	0.01nH	---	---	---	---
10uH	0.0001uH	---	---	---	1.5% + 0.1uH
100uH	0.001uH	---	---	---	0.7% + 0.1uH
1000uH	0.01uH	---	---	0.5% + 0.3uH	0.7% + 0.3uH
10mH	0.0001mH	---	---	0.4% + 0.003mH	0.5% + 0.003mH
100mH	0.001mH	0.5% + 0.03mH	0.5% + 0.03mH	0.4% + 0.03mH	0.7% + 0.03mH
1000mH	0.01mH	0.4% + 0.3mH	0.4% + 0.3mH	0.7% + 0.3mH	---

NOTE

The measurements are performed with necessary open and short calibration done prior to verifying the meter's accuracy.

Capacitance Accuracy Specifications

Table 4-7 LCR Elite2 Capacitance Accuracy Specifications

Range	Resolution	Accuracy = A_c + Offset			
		100Hz	120Hz	1kHz	10kHz
10pF	0.0001pF	---	---	---	1.0% + 0.1pF
100pF	0.001pF	---	---	---	0.5% + 0.2pF
1000pF	0.01pF	---	---	0.5% + 0.5pF	0.3% + 0.3pF
10nF	0.0001nF	---	---	0.3% + 0.003nF	0.2% + 0.003nF
100nF	0.001nF	---	---	0.2% + 0.03nF	0.3% + 0.03nF
1000nF	0.01nF	---	---	0.2% + 0.3nF	0.5% + 0.3nF
10uF	0.0001uF	0.4% + 0.003uF	0.4% + 0.003uF	0.3% + 0.003uF	---
100uF	0.001uF	0.3% + 0.03uF	0.3% + 0.03uF	0.5% + 0.03uF	---
1000uF	0.01uF	0.5% + 0.5uF	0.5% + 0.5uF	0.5% + 0.5uF	---
5mF	0.0001mF	0.7% + 0.005mF	0.7% + 0.005mF	---	---

NOTE

- (1) The measurements are performed with necessary open and short calibration done prior to verifying the meter's accuracy.
- (2) The accuracy for the ceramic capacitor will be influenced depending on the dielectric constant (K) of the material used to make the ceramic capacitor.