

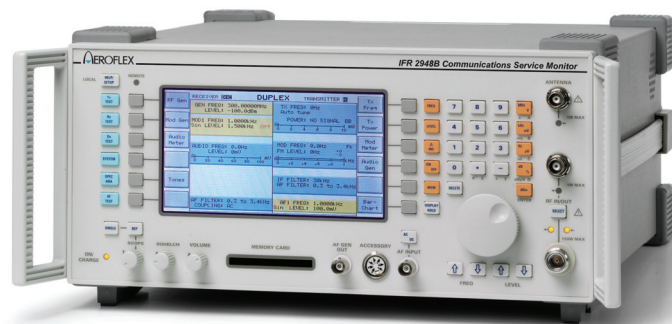

COMMUNICATIONS SERVICE MONITOR 2948B



Operating Manual

Document part no. 46892/692

COMMUNICATIONS SERVICE MONITOR 2948B

© Aeroflex International Ltd. 2007

*No part of this document may be reproduced or transmitted in any form
or by any means, electronic or mechanical, including photocopying,
or recorded by any information storage or retrieval system,
without permission in writing by Aeroflex International Ltd.
(hereafter referred to throughout the document as 'Aeroflex').*

Printed in the UK

Manual part no. 46882/692
Issue 2

4 September 2007

About this manual

This manual explains how to use the Communications Service Monitor 2948B. It applies to instruments fitted with main software version 5.xx or later and cellular software version 5.xx.

Intended audience

People who need to test mobile radio systems and associated equipment.

People who need to test airborne avionics receivers.

Structure

Chapter 1

General information and performance specification.

Chapter 2

Gives installation instructions, including connection of peripheral equipment.

Chapter 3

Operating instructions. Setting up and use.

Chapter 4

Brief technical description.

Chapter 5

Acceptance testing procedure for the Service Monitor.

Appendix A

Use of the Directional Power Heads, 54421/002 and 54421/003.

Appendix B

Operating instructions for Avionics system testing.

Document conventions

The following conventions apply throughout this manual:-

[Tx TEST]	Hard key titles are shown verbatim, using normal lettering in square brackets.
[Tx freq]	Soft key titles are shown verbatim using italic lettering in square brackets.
RF IN/OUT	Titles on the instrument panels are shown verbatim using capital letters.
	Text displayed on screen. See below [†]

[†] References to text displayed on the screen of the Service Monitor are given verbatim, using a font that resembles the displayed text. e.g. GEN FREQ: , Ref Level: , **Ref Level:**

contd./...

About this manual (continued)

Associated publications

Other manuals that cover specific aspects of this service monitor are:-

- Programming manual (46882/683) provides programming information for remote control of the Service Monitor using MI-BASIC and GPIB.
- Maintenance Manual (46882/694) provides servicing information for the Communications Service Monitor 2948B.

Operating manual supplements provide operating details for specific system test software.

- **AMPS Supplement** (46882/313)
- **EDACS Radio Supplement** (46882/301)
- **EDACS Repeater Supplement** (46882/300)
- **MPT1327 Supplement** (46882/317)
- **NMT Supplement** (46882/316)
- **PMR Supplement** (46882/315)
- **TACS Supplement** (46882/314)

Contents

	PRECAUTIONS	v
Chapter 1	GENERAL INFORMATION	1-1
	Performance data	1-7
Chapter 2	INSTALLATION	2-1
Chapter 3	LOCAL OPERATION	3-1
	Using the test modes	3-16
Chapter 4	TECHNICAL DESCRIPTION	4-1
Chapter 5	ACCEPTANCE TESTING	5-1
	Acceptance Test Results Tables	5-31
Appendix A	DIRECTIONAL POWER HEADS	A-1
Appendix B	AVIONICS SYSTEM	B-1
	Avionics system overview	B-2
	Avionics system operation	B-7
	INDEX	Index-1

Precautions

WARNING

CAUTION

Note

These terms have specific meanings in this manual:

WARNING

information to prevent personal injury.

CAUTION





information to prevent damage to the equipment.

Note

important general information.

Hazard symbols

The meaning of hazard symbols appearing on the equipment and in the documentation is as follows:

Symbol	Description
	Refer to the operating manual when this symbol is marked on the instrument. Familiarize yourself with the nature of the hazard and the actions that may have to be taken.
	Dangerous voltage
	Toxic hazard
	Hot surface

General conditions of use

This product is designed and tested to comply with the requirements of IEC/EN61010-1 'Safety requirements for electrical equipment for measurement, control and laboratory use', for Class I portable equipment and is for use in a pollution degree 2 environment. The equipment is designed to operate from an installation category I or II supply.

Equipment should be protected from the ingress of liquids and precipitation such as rain, snow, etc. When moving the instrument from a cold to a hot environment, it is important to allow the temperature of the instrument to stabilise before it is connected to the supply to avoid condensation forming. The instrument must only be operated within the environmental conditions specified in Chapter 1 'Performance Data' in the Operating/Instruction manual.

This product is not approved for use in hazardous atmospheres or medical applications. If the equipment is to be used in a safety-related application, e.g. avionics or military applications, the suitability of the product must be assessed and approved for use by a competent person.

WARNING



Electrical hazards (AC supply voltage)

This equipment conforms with IEC Safety Class I, meaning that it is provided with a protective grounding lead. To maintain this protection the supply lead must always be connected to the source of supply via a socket with a grounded contact.

Be aware that the supply filter contains capacitors that may remain charged after the equipment is disconnected from the supply. Although the stored energy is within the approved safety requirements, a slight shock may be felt if the plug pins are touched immediately after removal.

Do not remove instrument covers as this may result in personal injury. There are no user-serviceable parts inside.

Refer all servicing to qualified personnel. See list of Service Centers at rear of manual.

Fuses

Note that the internal supply fuse is in series with the live conductor of the supply lead. If connection is made to an unpolarized supply socket, it is possible for the fuse to become transposed to the neutral conductor, in which case, parts of the equipment could remain at supply potential even after the fuse has ruptured.

WARNING



Fire hazard

Make sure that only fuses of the correct rating and type are used for replacement.

If an integrally fused plug is used on the supply lead, ensure that the fuse rating is commensurate with the current requirements of this equipment. See under 'Performance Data' in Chapter 1 for power requirements.

WARNING



Toxic hazards

Some of the components used in this equipment may include resins and other materials which give off toxic fumes if incinerated. Take appropriate precautions, therefore, in the disposal of these items.

WARNING



Lithium

A Lithium battery (or a Lithium battery contained within an IC) is used in this equipment:

As Lithium is a toxic substance, the battery should in no circumstances be crushed, incinerated or disposed of in normal waste.

Do not attempt to recharge this type of battery. Do not short circuit or force discharge since this might cause the battery to vent, overheat or explode.

WARNING



Beryllium copper

Some mechanical components within this instrument are manufactured from beryllium copper. This is an alloy with a beryllium content of approximately 5%. It represents no risk in normal use.

The material should not be machined, welded or subjected to any process where heat is involved.

It must be disposed of as "special waste".

It must NOT be disposed of by incineration.

WARNING



Hot Surfaces

Take care when touching the RF Input Type N connector after the application of high levels of continuous power. If 50 W is exceeded for a prolonged period, the temperature of the connector can become excessive.

WARNING



RF hazard

When measuring high VSWR ratios, hazardous voltages may be present on the line due to standing waves. Under these conditions, it is dangerous to operate the equipment with the covers removed.

WARNING



Tilt facility

When the equipment is in the tilt position, it is advisable, for stability reasons, not to stack other equipment on top of it.

CAUTION

Suitability for use

This equipment has been designed and manufactured by Aeroflex to generate, receive and analyze RF/audio signals

If the equipment is not used in a manner specified by Aeroflex, the protection provided by the equipment may be impaired.

Aeroflex has no control over the use of this equipment and cannot be held responsible for events arising from its use other than for its intended purpose.

Precautions

WARNING

CAUTION

Note

Les termes suivants ont, dans ce manuel, des significations particulières:

WARNING

contient des informations pour éviter toute blessure au personnel.

CAUTION





contient des informations pour éviter les dommages aux équipements.

Note

contient d'importantes informations d'ordre général.

Symboles signalant un risque

La signification des symboles de danger apparaissant sur l'équipement et dans la documentation est la suivante:

Symbole	Nature du risque
	Reportez-vous au manuel d'utilisation quand ce symbole apparaît sur l'instrument. Familiarisez-vous avec la nature du danger et la conduite à tenir.
	Tension dangereuse
	Danger produits toxiques
	Surfaces chaudes

Conditions générales d'utilisation

Ce produit a été conçu et testé pour être conforme aux exigences des normes CEI/EN61010-1 « exigences de sécurité des équipements électriques pour la mesure, le contrôle et l'usage en laboratoire », pour des équipements Classe I portables et pour une utilisation dans un environnement de pollution de niveau 2. Cet équipement est conçu pour fonctionner à partir d'une alimentation de catégorie I ou II.

Cet équipement doit être protégé de l'introduction de liquides ainsi que des précipitations d'eau, de neige, etc... Lorsqu'on transporte cet instrument d'un environnement chaud vers un environnement froid, il est important de laisser l'instrument se stabiliser en température avant de le connecter à une alimentation afin d'éviter toute formation de condensation. L'instrument doit être utilisé uniquement dans les conditions d'environnement spécifiées dans le chapitre 1 « Performances » du manuel d'utilisation.

Ce produit n'est pas garanti pour fonctionner dans des atmosphères dangereuses ou pour un usage médical. Si l'équipement doit être utilisé pour des applications en relation avec la sécurité, par exemple des applications militaires ou aéronautiques, la compatibilité du produit doit être établie et approuvée par une personne compétente.

WARNING



Sécurité électrique (tension d'alimentation alternative)

Cet appareil est protégé conformément à la norme CEI de sécurité Classe 1, c'est-à-dire que sa prise secteur comporte un fil de protection à la terre. Pour maintenir cette protection, le câble d'alimentation doit toujours être branché à la source d'alimentation par l'intermédiaire d'une prise comportant une borne de terre.

Notez que les filtres d'alimentation contiennent des condensateurs qui peuvent encore être chargés lorsque l'appareil est débranché. Bien que l'énergie contenue soit conforme aux exigences de sécurité, il est possible de ressentir un léger choc si l'on touche les bornes sitôt après débranchement.

Ne démontez pas le capot de l'instrument, car ceci peut provoquer des blessures. Il n'y a pas de pièces remplaçables par l'utilisateur à l'intérieur.

Faites effectuer toute réparation par du personnel qualifié. Contacter un des Centres de Maintenance Internationaux dans la liste jointe à la fin du manuel.

Fusibles

Notez que le fusible d'alimentation interne est en série avec la phase (fil brun) du câble d'alimentation. Si la prise d'alimentation est non polarisée, il est possible de connecter le fusible au neutre. Dans ce cas, certaines parties de l'appareil peuvent rester à un certain potentiel même après coupure du fusible.

WARNING



Risque lié au feu

Lors du remplacement des fusibles vérifiez l'exactitude de leur type et de leur valeur.

Si le câble d'alimentation comporte une prise avec fusible intégré, assurez vous que sa valeur est compatible avec les besoins en courant de l'appareil. Pour la consommation, reportez-vous au Chapitre 1 "Spécifications".

WARNING



Danger produits toxiques

Certains composants utilisés dans cet appareil peuvent contenir des résines et d'autres matières qui dégagent des fumées toxiques lors de leur incinération. Les précautions d'usages doivent donc être prises lorsqu'on se débarrasse de ce type de composant.

WARNING



Lithium

Une pile au Lithium ou un CI contenant une pile au Lithium est utilisé dans cet équipement. Le Lithium est une substance toxique; en conséquence on ne doit l'écraser, l'incinérer ou la jeter dans la "poubelle".

Ne pas essayer de la recharger, ne pas la court-circuiter, une forte décharge rapide risque de provoquer une surchauffe voire l'explosion de celle-ci.

WARNING



Bronze au béryllium

Dans cet équipement, certaines pièces mécaniques sont à base de bronze au béryllium. Il s'agit d'un alliage dans lequel le pourcentage de béryllium ne dépasse pas 5%. Il ne présente aucun danger en utilisation normale.

Toutefois, cet alliage ne doit pas être travaillé, soudé ou soumis à un processus qui implique l'utilisation d'une source de chaleur.

En cas de destruction, il sera entreposé dans un container spécial. IL ne devra pas être détruit par incinération.

WARNING



Surfaces chaudes

Faire attention ,lors de la manipulation d'un connecteur "N", après l'injection de haute puissance en continu sur l'entrée RF de ce connecteur: Si une puissance supérieure à 50 W est envoyée pendant une longue durée, la température du connecteur peut être très élevée.

WARNING



Danger RF

Lors de la mesure de T.O.S. de valeur importante, des tensions dangereuses dues aux ondes stationnaires peuvent apparaître sur l'alimentation. Dans ces conditions il est dangereux de faire fonctionner l'appareil sans ses capots de protection.

WARNING



Position inclinée

Lorsque l'appareil est dans une position inclinée, il est recommandé, pour des raisons de stabilité, de ne pas y empiler d'autres appareils.

CAUTION

Utilisation

Cet équipement a été conçu et fabriqué par Aeroflex pour générer, recevoir et analyser des signaux RF et audios

La protection de l'équipement peut être altérée s'il n'est pas utilisé dans les conditions spécifiées par Aeroflex.

Aeroflex n'a aucun contrôle sur l'usage de l'instrument, et ne pourra être tenu pour responsable en cas d'événement survenant suite à une utilisation différente de celle prévue.

Vorsichtsmassnahmen

WARNING

CAUTION

Note

Diese Hinweise haben eine bestimmte Bedeutung in diesem Handbuch:

WARNING

dienen zur Vermeidung von Verletzungsrisiken.

CAUTION





dienen dem Schutz der Geräte.

Note

enthalten wichtige Informationen.

Gefahrensymbole

Die Bedeutung der Gefahrensymbole auf den Geräten und in der Dokumentation ist wie folgt:

Symbol	Gefahrenart
	Beziehen Sie sich auf die Bedienungsanleitung wenn das Messgerät mit diesem Symbol markiert ist. Machen Sie sich mit der Art der Gefahr und den Aktionen die getroffen werden müssen bekannt.
	Gefährliche Spannung
	Warnung vor giftigen Substanzen
	Heiße Oberfläche

Allgemeine Hinweise zur Verwendung

Dieses Produkt wurde entsprechend den Anforderungen von IEC/EN61010-1 "Sicherheitsanforderungen für elektrische Ausrüstung für Meßaufgaben, Steuerung und Laborbedarf", Klasse I transportabel zur Verwendung in einer Grad 2 verunreinigten Umgebung, entwickelt und getestet. Dieses Gerät ist für Netzversorgung Klasse I oder II zugelassen.

Das Meßgerät sollte vor dem Eindringen von Flüssigkeiten sowie vor Regen, Schnee etc. geschützt werden. Bei Standortänderung von kalter in wärmere Umgebung sollte das Meßgerät wegen der Kondensation erst nach Anpassung an die wärmere Umgebung mit dem Netz verbunden werden. Das Meßgerät darf nur in Umgebungsbedingungen wie in Kapitel 1 "Leistungsdaten (Performance data)" der Bedienungsanleitung beschrieben, betrieben werden.

Dieses Produkt ist nicht für den Einsatz in gefährlicher Umgebung (z.B. Ex-Bereich) und für medizinische Anwendungen geprüft. Sollte das Gerät für den Einsatz in sicherheitsrelevanten Anwendungen wie z.B. im Flugverkehr oder bei militärischen Anwendungen vorgesehen sein, so ist dieser von einer für diesen Bereich zuständigen Person zu beurteilen und genehmigen.

WARNING



Elektrische Schläge (Wechselspannungsversorgung)

Das Gerät entspricht IEC Sicherheitsklasse 1 mit einem Schutzleiter nach Erde. Das Netzkabel muß stets an eine Steckdose mit Erdkontakt angeschlossen werden.

Filterkondensatoren in der internen Spannungsversorgung können auch nach Unterbrechung der Spannungszuführung noch geladen sein. Obwohl die darin gespeicherte Energie innerhalb der Sicherheitsmargen liegt, kann ein leichter Spannungsschlag bei Berührung kurz nach der Unterbrechung erfolgen.

Öffnen Sie niemals das Gehäuse der Geräte das dies zu ernsthaften Verletzungen führen kann. Es gibt keine vom Anwender austauschbare Teile in diesem Gerät.

Lassen Sie alle Reparaturen durch qualifiziertes Personal durchführen. Eine Liste der Servicestellen finden Sie auf der Rückseite des Handbuchs.

Sicherungen

Die interne Sicherung in der Spannungszuführung ist in Reihe mit der spannungsführenden Zuleitung (braun) geschaltet. Bei Verbindung mit einer nicht gepolten Steckdose kann die Sicherung in der Masseleitung liegen, so daß auch bei geschmolzener Sicherung Geräteteile immer noch auf Spannungspotential sind.

WARNING



Feuergefahr

Es dürfen nur Ersatzsicherungen vom gleichen Typ mit den korrekten Spezifikationen entsprechend der Stromaufnahme des Gerätes verwendet werden. Siehe hierzu die Leistungsdaten (Performance Data) in Kapitel 1.

WARNING



Warnung vor giftigen Substanzen

In einigen Bauelementen dieses Geräts können Epoxyharze oder andere Materialien enthalten sein, die im Brandfall giftige Gase erzeugen. Bei der Entsorgung müssen deshalb entsprechende Vorsichtsmaßnahmen getroffen werden.

WARNING



Lithium

Eine Lithium Batterie oder eine Lithium Batterie innerhalb eines IC ist in diesem Gerät eingebaut. Da Lithium ein giftiges Material ist, sollte es als Sondermüll entsorgt werden.

Diese Batterie darf auf keinen Fall geladen werden. Nicht kurzschließen, da sie dabei überhitzt werden und explodieren kann.

WARNING



Beryllium Kupfer

In diesem Gerät sind einige mechanische Komponenten aus Beryllium Kupfer gefertigt. Dies ist eine Verbindung welche aus einem Berylliumanteil von ca. 5 % besteht. Bei normaler Verwendung besteht kein Gesundheitsrisiko.

Das Metall darf nicht bearbeitet, geschweißt oder sonstiger Wärmebehandlung ausgesetzt werden.

Es muß als Sondermüll entsorgt werden.

Es darf nicht durch Verbrennung entsorgt werden.

WARNING



Heiße Oberfläche

Vorsicht bei Berührung der HF Eingangsbuchse Typ N nach Einspeisen hoher Dauerleistung. Falls über längere Zeit 50 Watt überschritten wird, kann die Temperatur der Buchse über Normal steigen.

WARNING



Hochfrequenz

Bei Messung von hohen Stehwellenverhältnissen können sich auf der Leitung gefährliche Spannungen aufbauen. In solchen Fällen darf das Gerät nicht bei geöffnetem Gehäuse betrieben werden.

WARNING



Schrägstellung

Bei Schrägstellung des Geräts sollten aus Stabilitätsgründen keine anderen Geräte darauf gestellt werden.

CAUTION

Eignung für Gebrauch

Dieses Gerät wurde von Aeroflex entwickelt und hergestellt um HF/Audio Signale zu erzeugen, zu empfangen und zu analysieren

Sollte das Gerät nicht auf die von Aeroflex vorgesehene Art und Weise verwendet werden, kann die Schutzfunktion des Gerätes beeinträchtigt werden.

Aeroflex hat keinen Einfluß auf die Art der Verwendung und übernimmt keinerlei Verantwortung bei unsachgemässer Handhabung.

Precauzioni

WARNING

CAUTION

Note

Questi termini vengono utilizzati in questo manuale con significati specifici:

WARNING

riportano informazioni atte ad evitare possibili pericoli alla persona.

CAUTION





riportano informazioni per evitare possibili pericoli all'apparecchiatura.

Note

riportano importanti informazioni di carattere generale.

Simboli di pericolo

Il significato del simbolo di pericolo riportato sugli strumenti e nella documentazione è il seguente:

Simbolo	Tipo di pericolo
	Fare riferimento al manuale operativo quando questo simbolo è riportato sullo strumento. Rendervi conto della natura del pericolo e delle precauzioni che dovrete prendere.
	Tensione pericolosa
	Pericolo sostanze tossiche
	Superfici ad alta temperatura

Condizioni generali d'uso.

Questo prodotto è stato progettato e collaudato per rispondere ai requisiti della direttiva IEC/EN61010-1 'Safety requirements for electrical equipment for measurement, control and laboratory use' per apparati di classe I portatili e per l'uso in un ambiente inquinato di grado 2. L'apparato è stato progettato per essere alimentato da un alimentatore di categoria I o II.

Lo strumento deve essere protetto dal possibile ingresso di liquidi quali, ad es., acqua, pioggia, neve, ecc. Qualora lo strumento venga portato da un ambiente freddo ad uno caldo, è importante lasciare che la temperatura all'interno dello strumento si stabilizzi prima di alimentarlo per evitare formazione di condense. Lo strumento deve essere utilizzato esclusivamente nelle condizioni ambientali descritte nel capitolo I 'Performance Data' del manuale operativo.

Questo prodotto non è stato approvato per essere usato in ambienti pericolosi o applicazioni medicali. Se lo strumento deve essere usato per applicazioni particolari collegate alla sicurezza (per esempio applicazioni militari o avioniche), occorre che una persona o un istituto competente ne certifichi l'uso.

WARNING



Pericoli da elettricità (alimentazione c.a.)

Quest' apparato è provvisto del collegamento di protezione di terra e rispetta le norme di sicurezza IEC, classe 1. Per mantenere questa protezione è necessario che il cavo, la spina e la presa d'alimentazione siano tutti provvisti di terra.

Il circuito d'alimentazione contiene dei filtri i cui condensatori possono restare carichi anche dopo aver rimosso l'alimentazione. Sebbene l'energia immagazzinata è entro i limiti di sicurezza, purtuttavia una leggera scossa può essere avvertita toccando i capi della spina subito dopo averla rimossa.

Non rimuovete mai le coperture perché così potreste provocare danni a voi stessi. Non vi sono all'interno parti di interesse all'utilizzatore.

Tutte gli interventi sono di competenza del personale qualificato. Vedi elenco internazionale dei Centri di Assistenza in fondo al manuale.

Fusibili

Notare che un fusibile è posto sul filo caldo (marrone) del cavo di alimentazione. Se l'alimentazione avviene tramite una presa non polarizzata, è possibile che il fusibile vada a protezione del neutro per cui anche in caso di una sua rottura, l'apparato potrebbe restare sotto tensione.

WARNING



Pericolo d'incendio

Assicurarsi che, in caso di sostituzione, vengano utilizzati solo fusibili della portata e del tipo prescritti.

Se viene usata una spina con fusibili, assicurarsi che questi siano di portata adeguata coi requisiti di alimentazione richiesti dallo strumento. Tali requisiti sono riportati nel cap. 1 "Performance data".

WARNING



Pericolo sostanze tossiche

Alcuni dei componenti usati in questo strumento possono contenere resine o altri materiali che, se bruciati, possono emettere fumi tossici. Prendere quindi le opportune precauzioni nell'uso di tali parti.

WARNING



Litio

Quest'apparato incorpora una batteria al litio o un circuito integrato contenente una batteria al litio. Poiché il litio è una sostanza tossica, la batteria non deve essere mai né rotta, né incenerita, né gettata tra i normali rifiuti.

Questo tipo di batteria non può essere sottoposto né a ricarica né a corto-circuito o scarica forzata. Queste azioni possono provocare surriscaldamento, fuoriuscita di gas o esplosione della batteria.

WARNING



Rame berillio

Alcuni componenti meccanici in questo strumento sono realizzati in rame berillio. Si tratta di una lega con contenuto di berillio di circa il 5%, che non presenta alcun rischio in usi normali.

Questo materiale non deve essere lavorato, saldato o subire qualsiasi processo che coinvolge alte temperature.

Deve essere eliminato come "rifiuto speciale". Non deve essere eliminato tramite "inceneritore".

WARNING



Superfici ad alta temperatura

Fare attenzione nel toccare il connettore d'ingresso di tipo N dopo aver applicato una potenza elevata e continua. Una potenza superiore a 50 W per tempi prolungati può portare il connettore ad una temperatura molto elevata.

WARNING



Rischio a RF

Durante la misura di ROS di valori elevati, la presenza di onde stazionarie può causare tensioni pericolose. In queste condizioni è quindi rischioso usare lo strumento coi coperchi rimossi.

WARNING



Posizionamento inclinato

Quando lo strumento è in posizione inclinata è raccomandato, per motivi di stabilità, non sovrapporre altri strumenti.

CAUTION

Caratteristiche d'uso

Questo strumento è stato progettato e prodotto da Aeroflex generare, ricevere ed analizzare segnali RF/audio

Se lo strumento non è utilizzato nel modo specificato da Aeroflex, le protezioni previste sullo strumento potrebbero risultare inefficaci.

Aeroflex non può avere il controllo sull'uso di questo strumento e non può essere ritenuta responsabile per eventi risultanti da un uso diverso dallo scopo prefisso.

Precauciones

WARNING

CAUTION

Note

Estos términos tienen significados específicos en este manual:

WARNING

contienen información referente a prevención de daños personales.

CAUTION





contienen información referente a prevención de daños en equipos.

Note

contienen información general importante.

Símbolos de peligro

El significado de los símbolos de peligro en el equipo y en la documentación es el siguiente:

Símbolo	Naturaleza del peligro
	Vea el manual de funcionamiento cuando este símbolo aparezca en el instrumento. Familiarícese con la naturaleza del riesgo y con las acciones que deban de tomarse.
	Voltaje peligroso
	Aviso de toxicidad
	Superficies a altas temperaturas

Condiciones generales de uso

Este producto ha sido diseñado y probado para cumplir los requerimientos de la normativa IEC/EN61010-1 "Requerimientos de la normativa para equipos eléctricos de medida, control y uso en laboratorio", para equipos clase I portátiles y para uso en un ambiente con un grado de contaminación 2. El equipo ha sido diseñado para funcionar sobre una instalación de alimentación de categorías I o II.

Debe protegerse el equipo de la entrada de líquidos y precipitaciones como nieve, lluvia, etc. Cuando se traslada el equipo de entorno frío a un entorno caliente, es importante aguardar la estabilización del equipo para evitar la condensación. Sólo debe utilizarse el aparato en las condiciones ambientales especificadas en el capítulo 1 "Especificaciones" o "Performance Data" del Manual de Instrucciones/Manual de Operación/Funcionamiento.

Este producto no ha sido aprobado para su utilización en entornos peligrosos o en aplicaciones médicas. Si se va a utilizar el equipo en una aplicación con implicaciones en cuanto a seguridad, como por ejemplo aplicaciones de aviónica o militares, es preciso que un experto competente en materia de seguridad apruebe su uso.

WARNING



Nivel peligroso de electricidad (tensión de red)

Este equipo cumple las normas IEC Seguridad Clase 1, lo que significa que va provisto de un cable de protección de masa. Para mantener esta protección, el cable de alimentación de red debe de conectarse siempre a una clavija con terminal de masa.

Tenga en cuenta que el filtro de red contiene condensadores que pueden almacenar carga una vez desconectado el equipo. Aunque la energía almacenada está dentro de los requisitos de seguridad, pudiera sentirse una ligera descarga al tocar la clavija de alimentación inmediatamente después de su desconexión de red.

No retire las cubiertas del chasis del instrumento, ya que pudiera resultar dañado personalmente. No existen partes que puedan ser reparadas en su interior.

Deje todas las tareas relativas a reparación a un servicio técnico cualificado. Vea la lista de Centros de Servicios Internacionales en la parte trasera del manual.

Fusibles

Se hace notar que el fusible de alimentación interno está en serie con el activo (marrón) del cable de alimentación a red. Si la clavija de alimentación de red no tiene polaridad, el fusible puede pasar a estar en serie con el neutro, en cuyo caso existen partes del equipo que permanecerían a tensión de red incluso después de que el fusible haya fundido.

WARNING



Peligro de incendio

Asegúrese de utilizar sólo fusibles del tipo y valores especificados como repuesto. Si se utiliza una clavija con fusible incorporado, asegúrese de que los valores del fusible corresponden a los requeridos por el equipo. Ver sección de especificaciones del capítulo 1 para comprobar los requisitos de alimentación.

WARNING



Aviso de toxicidad

Alguno de los componentes utilizados en este equipo pudieran incluir resinas u otro tipo de materiales que al arder produjeran sustancias tóxicas. Por tanto, tome las debidas precauciones en la manipulación de esas piezas.

WARNING



Litio

En este equipo se utiliza una batería de litio (o contenida dentro de un CI). Dada que el litio es una sustancia tóxica las baterías de este material no deben ser aplastadas, quemadas o arrojadas junto a basuras ordinarias. No trate de recargar este tipo de baterías. No las cortocircuite o fuerce su descarga ya que puede dar lugar a que la esta emita gases, se recaliente o explote.

WARNING



Berilio-cobre

Algunos componentes mecánicos contenidos en este instrumento incorporan berilio-cobre en su proceso de fabricación. Se trata de una aleación con un contenido aproximado de berilio del 5%, lo que no representa ningún riesgo durante su uso normal.

El material no debe ser manipulado, soldado, ni sometido a ningún proceso que implique la aplicación de calor.

Para su eliminación debe tratarse como un "residuo especial". El material NO DEBE eliminarse mediante incineración.

WARNING



Superficies a altas temperaturas

Tenga cuidado al tocar el conector de entrada RF tipo N tras la aplicación continuada de altos niveles de potencia. La temperatura del conector puede llegar a ser excesiva si se sobrepasan 50 W durante un periodo prolongado de tiempo.

WARNING



Riesgo de RF

Cuando se miden valores elevados de ROE, pueden existir tensiones elevadas debido a ondas estacionarias. Bajo estas condiciones resulta peligroso operar con el equipo sin las tapas puestas.

WARNING



Tener en cuenta con el equipo inclinado

Si utiliza el equipo en posición inclinada, se recomienda, por razones de estabilidad, no apilar otros equipos encima de él.

CAUTION

Idoneidad de uso

Este equipo ha sido diseñado y fabricado por Aeroflex para generar, recibir y analizar señales de RF/audio

Si el equipo fuese utilizado de forma diferente a la especificada por Aeroflex, la protección ofrecida por el equipo pudiera quedar reducida.

Aeroflex no tiene control sobre el uso de este equipo y no puede, por tanto, exigirse responsabilidades derivadas de una utilización distinta de aquellas para las que ha sido diseñado.

Chapter 1

GENERAL INFORMATION

Contents

Purpose and features	1-2
Transmitter testing	1-3
Receiver testing.....	1-4
Duplex testing.....	1-4
Systems testing	1-5
Spectrum analyzer.....	1-6
AF testing.....	1-6
Performance data.....	1-7
Receiver measurements	1-7
Audio analyzer.....	1-9
Transmitter measurements	1-11
RF spectrum analyzer	1-13
Audio generators.....	1-14
Cellular and trunking	1-15
Frequency standard.....	1-15
General.....	1-16
General features	1-16
Options and accessories	1-17

List of figures

Fig. 1-1 Transmitter test set-up.....	1-3
Fig. 1-2 Receiver test setup.....	1-4
Fig. 1-3 One port duplex test setup.....	1-4
Fig. 1-4 Two port duplex test setup	1-5
Fig. 1-5 Cellular radio-telephone test setup	1-5
Fig. 1-6 AF test setup.....	1-6

Purpose and features

2948B is a portable Communications Service Monitor for carrying out production, routine and maintenance testing on radio transmitters, receivers and two way radio communication equipment. The SYSTEM mode provides test facilities for ILS, VOR and SELCAL receivers. The Service Monitor contains modules to provide facilities equivalent to the following instruments:-

RF generator, two audio generators, specialized tones generator, RF power meter, modulation meter, RF counter, AF counter, AF voltmeter, distortion meter, large screen digital oscilloscope, spectrum analyzer and monitoring receiver.

Distortion measuring filters, AF post demodulation filters and IF passband filters, are built in for inclusion in relevant measurement paths.

The signal obtained from the demodulators, when in Tx test mode, is fed to an AF amplifier and can be monitored on the built-in loudspeaker, on headphones connected to the accessory socket, or taken from the DEMOD OUT connector to other equipment.

The monitor has a wide range of test capabilities including base station, mobile and transponder commissioning and servicing, radio telephone system and radio pager testing, as well as production testing to all of the above.

The selection of a test mode configures the modules into set-ups ready for connection to the equipment to be tested and produces the appropriate set-up screen on the display. The set-up screen shows the settings of the active modules, records changes to settings as they are made and gives readouts of test results both digitally and on bargraphs.

The modules of the monitor can each be used to perform as individual test instruments.

A hard copy of most screens can be made to a suitable printer using the screen capture feature. This is one of the functions accessed after pressing the [DISPLAY HOLD] key on the front panel. See *Front panel layout, DISPLAY HOLD key*, in Chapter 3.

A memory facility allows settings and test results to be stored within the Service Monitor. With the memory card option fitted, these can be stored on memory cards. This also allows settings to be exchanged between Service Monitors.

The memory card option also includes a real time clock which provides date/time stamping to stored results and to screen-capture printouts.

The RS232 control facility permits operation of the Service Monitor by remote or automatic control as an alternative or supplement to the conventional front panel local control.

The programming manual 46882/318, supplied with the Service Monitor provides comprehensive information relating to operation by remote control. It also contains the command list, with structure details and examples.

The test modes are outlined in the following descriptions, with interconnection diagrams showing the principles of the test procedures.

Transmitter testing

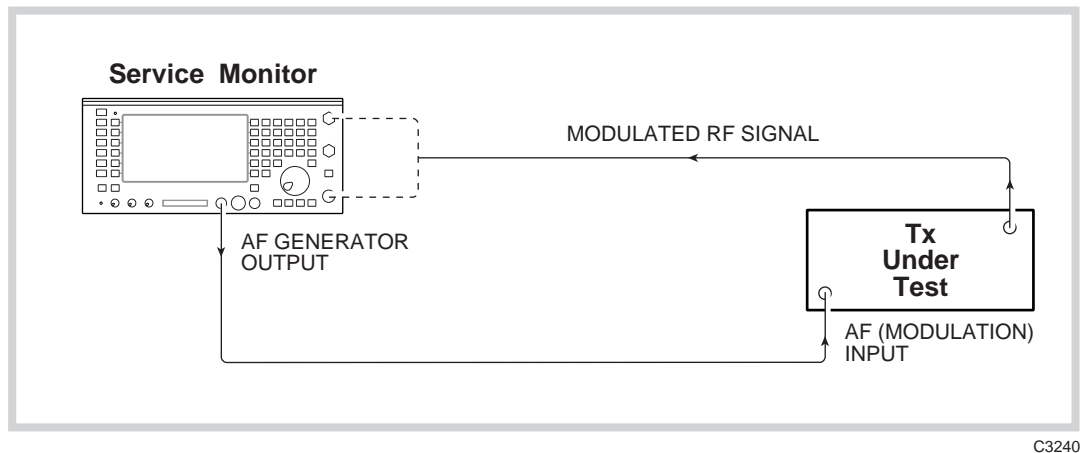

C3240

Fig. 1-1 Transmitter test set-up

The transmitter test procedure uses:-

The AF generators, to provide a source of modulation for the transmitter under test.

The RF power meter, to measure the mean output power level of the transmitter.

The RF counter, to obtain the mean RF frequency of the transmitter output.

The modulation meter, to measure the modulation depth or the deviation level and to provide a demodulated output signal. Single sideband transmissions can be demodulated when the SSB option is implemented.

The AF counter, to measure the frequency of the demodulated signal.

The distortion meter, to obtain the signal to noise level, the modulation distortion percentage or the modulation SINAD level of the transmitter.

The oscilloscope, to view the demodulated signal and to measure the modulation levels.

The tones generator, to modulate transmitters of systems using tone calling.

The tones decoder, to demodulate tones generated by the transmitter.

The AF amplifier and loudspeaker, to monitor the demodulated signal.

Cellular radio-telephones can be tested using the SYSTEMS mode. (See 'System testing').

The spectrum analyzer facility, which is a separate operating mode (SPEC ANA), can be used to study the sidebands and any harmonics produced by the transmitter, either by direct connection or by off-air monitoring.

Receiver testing

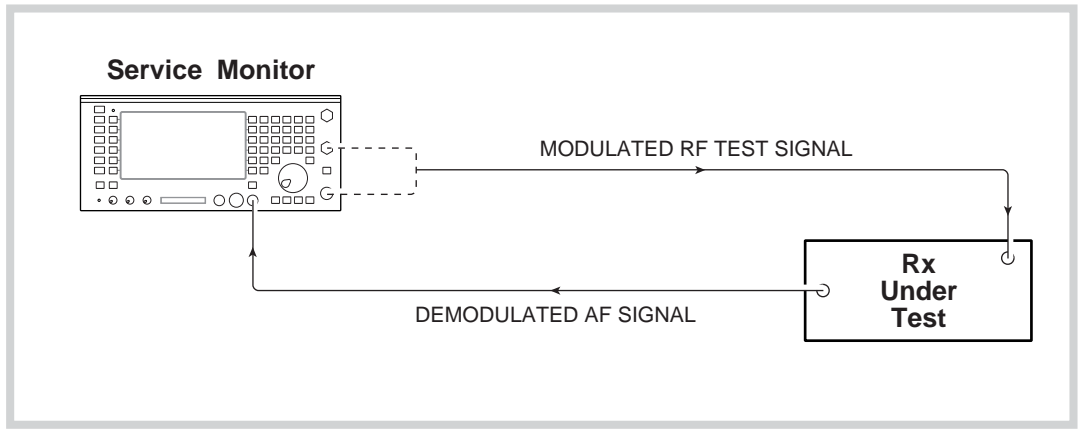

C3241

Fig. 1-2 Receiver test setup

The receiver test procedure uses:-

- The RF generator and the AF generators, to produce a transmission with defined parameters.

- The AF voltmeter, to measure the level of the demodulated signal from the receiver.

- The distortion meter, to obtain signal-to-noise ratio, SINAD levels and distortion percentage figures.

- The tone generator and tone detector, to produce and decode specialized calling tones to test tone recognition circuits.

- The oscilloscope, to view and measure the demodulated signal or other waveforms.

The RF signal from the Service Monitor is coupled to the receiver and the demodulated signal from the receiver taken to the AF input of the Service Monitor. By measuring the levels of the AF signal from the receiver, the sensitivity of the receiver can be checked. The distortion levels introduced by the receiver can be measured.

During all of the above procedures, the RF levels, the distortion levels and modulation levels can be displayed on bar charts as well as being provided as a digital read-out. The AF waveforms can also be studied using the digital oscilloscope facility.

Duplex testing

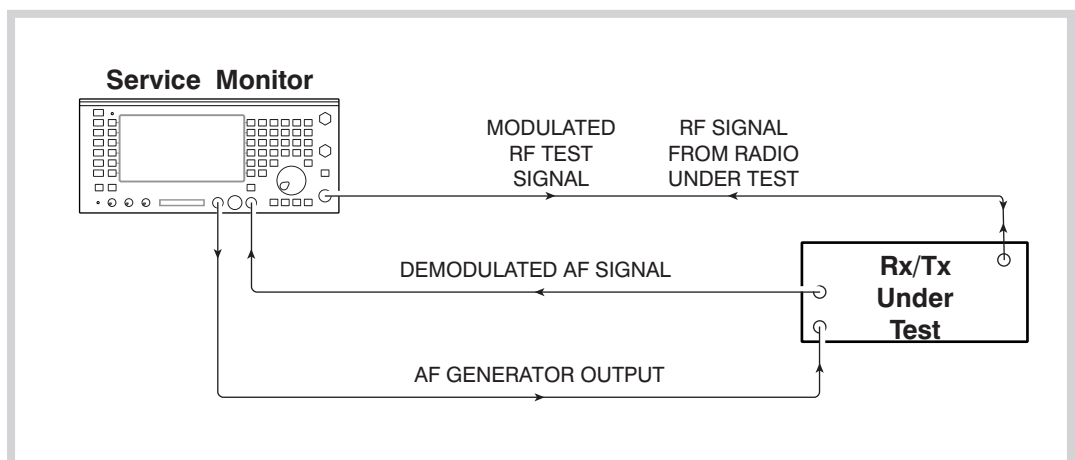

C5442

Fig. 1-3 One port duplex test setup

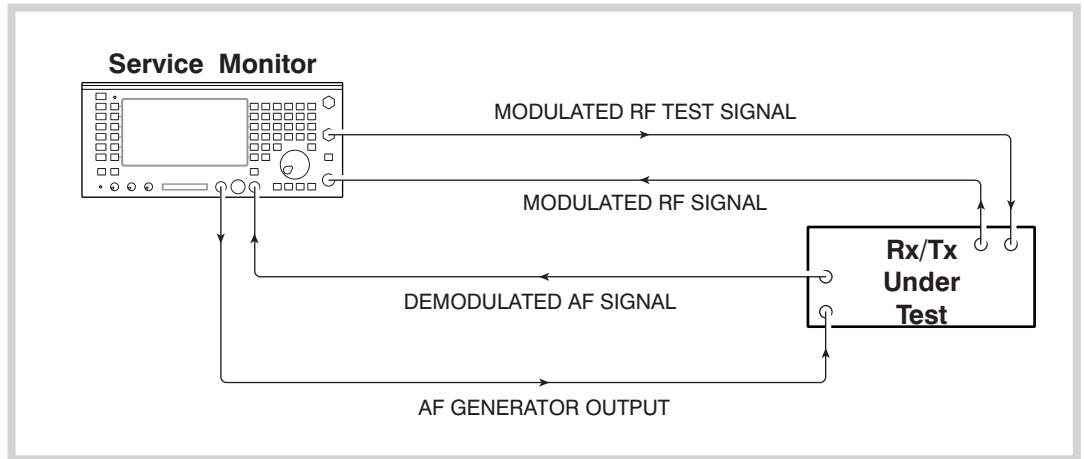

C5385

Fig. 1-4 Two port duplex test setup

Using the Duplex test facility, parameters for transmitter testing and receiver testing can be set up and displayed on one screen. This gives the capability to study the performance of duplex transceivers. Both one port and two port units can be tested.

Systems testing

Cellular and trunked radio-telephone systems

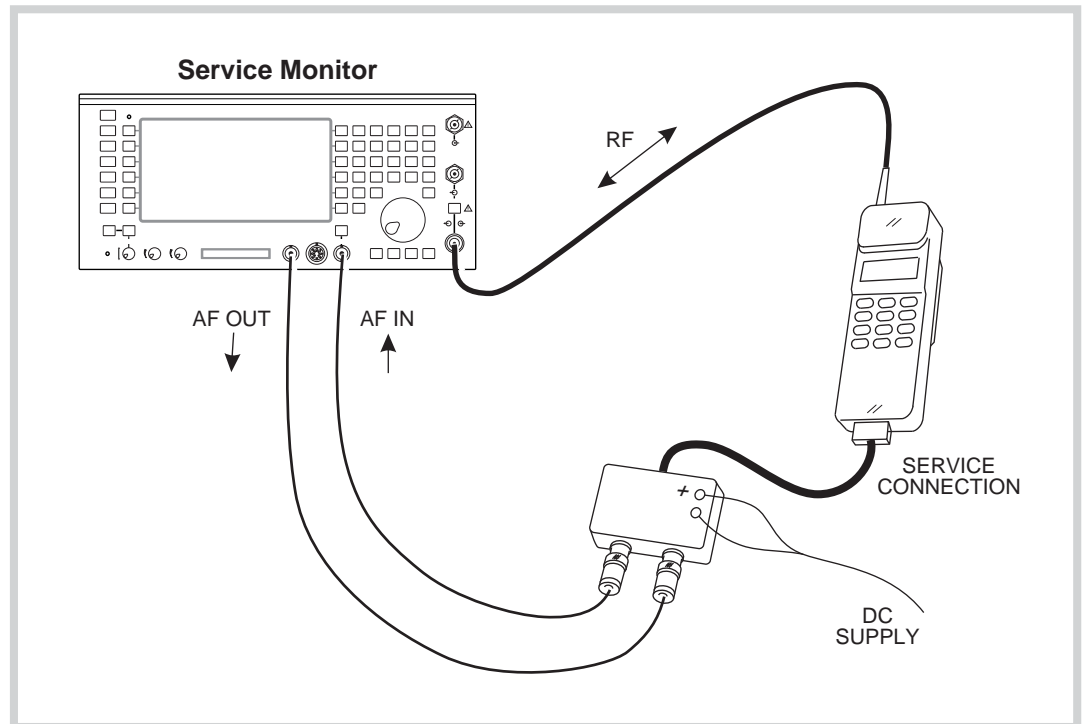

C3253

Fig. 1-5 Cellular radio-telephone test setup

With the appropriate cellular or trunked mobile telephone option included, the monitor has built-in software to generate and interrogate signals of the various cellular or trunked telephone systems. This gives the facility for testing all aspects of these systems.

Inbuilt test programs and user programming facilities give speed and flexibility to these tests.

Operating instructions for each of the SYSTEM test options is given in separate supplements to this manual. These supplements are supplied, as appropriate, with Service Monitors fitted with SYSTEM testing options.

Avionics systems

The Avionics SYSTEM test facility is capable of carrying out functional testing and performance evaluation of airborne radio navigation and communication equipment. Appendix B, Avionics System, covers the operation of this facility.

Spectrum analyzer

The SPEC ANA mode allows 'off air' and directly coupled RF signals to be studied and monitored.

Sideband spread, harmonic levels and RF interference can be examined.

The frequency range of the spectrum analyzer is from 100 kHz to 1.0 GHz with the start and stop frequencies of the sweep infinitely variable from within this range.

The tracking generator permits frequency response tests to be made to frequency dependent circuits and the frequency offset facility extends this capability into the area of frequency shifting circuits, such as mixers.

The 'Look and Listen' function gives the ability to demodulate a signal displayed on the spectrum analyzer and monitor the signal obtained on the built-in loudspeaker, on headphones or other data output equipment.

AF testing

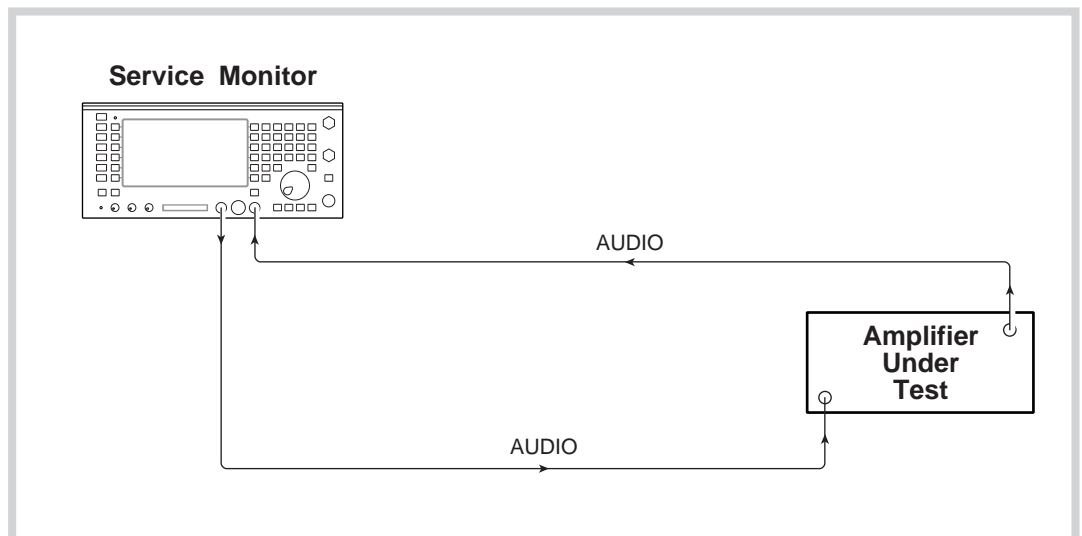

C3244

Fig. 1-6 AF test setup

The AF testing mode allows the dual AF generators and the tones generator to be used as a signal source. The AF voltmeter, distortion meter, bar chart displays and the AF counter can all be used to provide data relating to signals applied to the AF input connector. The digital oscilloscope is also available for studying AF waveforms.

Performance data

Receiver measurements

RF signal generator

Frequency

Range	400 kHz to 1.05 GHz
Resolution	10 Hz
Indication	10 digit display
Setting	Keyboard entry, delta increment / decrement function and rotary control
Accuracy	As frequency standard

Output Level

Range	Rx Test: N-Type socket: -141 dBm to -21 dBm BNC socket: -115 dBm to +5 dBm (usable to +7 dBm)
Resolution	0.1 dB
Indication	4 digits plus sign (dBm, dB μ V, μ V, mV, PD/EMF).
Accuracy	± 2 dB for level above -127 dBm on N-Type socket up to 1 GHz

Attenuator Hold Facility

Allows user to define start point for seamless generator operation across a range of up to 20 dB (guaranteed 10 dB minimum). CW and FM modes only

Reverse Power Protection

N-Type: 50 W for 10 minutes, normal operation. 150 W for 1 minute at 20°C.
Overload indicated by audible and visual warning.
BNC: 5 W Tripping indicated by audible and visual warning.

Output Impedance

Nominally 50 Ω

VSWR N-Type	Better than 1.2:1 up to 500 MHz Better than 1.35:1 up to 1.05 GHz
VSWR BNC	Better than 2.2:1 up to 1.05 GHz

Spectral Purity

Residual FM	Less than 6 Hz RMS (0.3 to 3.4 kHz) <500 MHz Less than 12 Hz RMS (0.3 to 3.4 kHz)
Harmonics	Better than -25 dBc
Spurious signals	Better than -50 dBc
SSB phase noise (20 kHz offset)	Better than -112 dBc / Hz <500 MHz Better than -108 dBc / Hz up to 1 GHz
RF carrier leakage	Less than 0.5 μ V PD generated in a 50 Ω load by a 2 turn loop 25 mm from the case. Output level less than -40 dBm into a sealed 50 Ω load.

GENERAL INFORMATION

Amplitude Modulation – Internal

Frequency range	400 kHz to 1.05 GHz
AM depth range	0 to 99 %
Resolution	1 %
Indication	2 digits
Setting	Keyboard entry, delta increment / decrement function and rotary control
Accuracy	For carrier frequencies from 1.5 MHz to 400 MHz: ±5% at 50 % for mod freq of 1 kHz, ±7% ±1 digit, for mod freq of 1 kHz, ±15% ±1 digit, for mod freq of 50 Hz to 15 kHz
Distortion	Less than 2 % at 1 kHz for 30 %, CCITT weighted
Modulation Frequency Range	5 Hz to 33 kHz

Amplitude Modulation – External

Input impedance	Nominally 10 kΩ in parallel with 40 pF
Frequency Range	As internal AM
Modulation Frequency Range	As internal AM
Sensitivity	1.0 V RMS for 0 to 100% AM

Frequency Modulation – Internal

Frequency range	400 kHz to 1.05 GHz
Maximum deviation	75 kHz
Indication	3 digits
Setting	Keyboard entry, delta increment / decrement function and rotary control
Accuracy †	±7% at 1 kHz modulating frequency ±10% at modulating frequencies from 50 Hz to 15 kHz
Distortion	Less than 1% at 1 kHz for deviation of 5 kHz, CCITT weighted
Resolution	25 Hz
Pre-emphasis	750 μs selectable
Mod Frequency Range	5 Hz – 33 kHz

Frequency Modulation – External

Input impedance	Nominally 10 kΩ in parallel with 40 pF
Frequency Range	As internal FM
Modulation Frequency Range	DC to 100 kHz
Pre-emphasis	750 μs selectable
Sensitivity	1 V RMS for 0 to 75 kHz deviation

Microphone Input

Input Level	2 mV to 200 mV (AGC levelled)
Input Impedance	Nominally 150 Ω
Press To Talk (PTT)	When using the optional microphone in Tx Test mode, the PTT will switch the Service Monitor to Rx Test

† At low modulation levels the residual AM / FM may become significant

Audio analyzer

Audio Voltmeter

Input Impedance	Nominally 1 M Ω in parallel with 40 pF
Frequency Range	DC and 20 Hz to 50 kHz AC only 20 Hz to 50 kHz Polarized DC (below 1 Hz)
Maximum Input Voltage	30 V RMS, 50 V DC
Level Ranges	0-100 mV to 0-100 V RMS in a 1,3,10 sequence
Resolution	1 mV or 1% of reading
Indication	3 digits and bargraph
Accuracy (AC)	$\pm 3\%$ ± 3 mV \pm resolution up to 30 V RMS
Accuracy (DC)	$\pm 1\%$ +50 mV up to 40 V

Audio Frequency Meter

Frequency Range	20 Hz to 50 kHz
Resolution	0.1 Hz, less than 10 kHz 1 Hz, at 10 kHz and above
Indication	5 digits
Accuracy	As frequency standard ± 1 digit \pm resolution
Sensitivity	50 mV

Audio SINAD Meter

Frequency	1 kHz (additional frequencies available with Option 29)
Range	0 to 18 dB and 0 to 50 dB
Resolution	0.1 dB
Indication	3 digits and bargraphs
Accuracy	± 1 dB
Sensitivity	50 mV (100 mV for 40 dB SINAD). Reading suppressed if audio voltage is less than 5 mV.

Audio Distortion Meter

Frequency	1 kHz (additional frequencies available with Option 29)
Range	0 to 10 % and 0 to 30 %
Resolution	0.1 % distortion
Indication	3 digits and bargraphs
Accuracy	± 1 dB of reading ± 0.5 % distortion
Sensitivity	50 mV (100 mV for 1 % distortion). Reading suppressed if audio voltage is less than 5 mV.

Audio S/N Meter

Range	0 to 30 dB and 0 to 100 dB
Resolution	0.1 dB
Indication	3 digits and bargraph
Accuracy	± 1 dB
Sensitivity	50 mV (100 mV for 40 dB S/N). Reading suppressed if audio voltage is less than 5 mV.

GENERAL INFORMATION

Audio Oscilloscope

Operating Modes	Single or repetitive sweep
Frequency Range	DC to 50 kHz, 3 Hz to 50 kHz AC coupled
Voltage Range	10 mV to 20 V per division in a 1,2,5 sequence
Voltage Accuracy	$\pm 5\%$ of full scale
FM Ranges	$\pm 75, 30, 15, 6, 3$ and 1.5 kHz deviation full scale, $\pm 10\%$ accuracy
AM Ranges	20, 10 and 5% per division, $\pm 10\%$ accuracy
Timebase	50 μ s/div to 5 s/div in a 1,2,5 sequence
Graticule	10 Horizontal by 6 Vertical divisions
Special features	Built in antialiasing circuitry

Audio Barcharts

Barchart Displays	AF Voltage, SINAD, Distortion, S/N
Vertical Resolution	2 % of full scale
Ranging	Autoranging, range hold or manual selection 1, 2, 5, sequence with hysteresis

Audio and Modulation Filters

Lowpass Filters	Four independently configurable Lowpass filters LP1, LP2, LP3, LP4 that can be set to any frequency cut off point from 250 Hz to 20,000 Hz (excluding the band 1001 to 2999 Hz). A 50 kHz Lowpass (No filters applied). 750 μ s de-emphasis.
Highpass Filters	50 Hz Highpass 300 Hz Highpass
Bandpass Filters	Any combination of LP1, LP2, LP3, LP4 and the Highpass filters.

Transmitter measurements

RF Frequency Meter

Frequency Range	400 kHz to 1.05 GHz (manual tune) 10 MHz to 1 GHz (auto-tune)
Resolution	1 Hz or 10 Hz, selectable, <1050 MHz 0.1 Hz, 1 Hz, 10 Hz up to 999 MHz
Indication	Up to 10 digits
Accuracy	As frequency standard \pm resolution
Acquisition Time	Less than 1 second (manual). Typically 3 seconds (autotune)
Sensitivity	Autotuned: 5 mW (N-Type) 0.05 mW BNC (antenna port) Manual Tuned: -34 dBm (N-Type), -60 dBm BNC (antenna port) Auto or manual control of input attenuator
VSWR	N Type <1.2:1 to 500 MHz <1.25:1 to 1.05 GHz BNC (antenna port) <3:1 to 1.05 GHz

RF Power Meter (Broadband)

Frequency Range	200 kHz to 1.05 GHz
Dynamic Range	5 mW to 150 W (N-Type) 0.05 mW to 250 mW BNC (antenna port)
Indication Units	Watts, dBm or dBW
Indication	3 digits or bargraph
Resolution	0.1 dB, typically 1%
Accuracy	$\pm 10\%$ \pm resolution up to 1 GHz (FM and CW)
Maximum Continuous Rating	N-Type: 50W at 20°C BNC output: 5 W Antenna port: 1 W
Intermittent Rating	N-Type: 150 W for limited periods, typically 1 minute at 20°C Overload indicated by audible and visual warning

Harmonic Measurement

	Displays 1st to 5th harmonic of the carrier
Max. harmonic frequency	1.05 GHz
Dynamic range	0 to -60 dBc (depends on filter b/w selected)

Transient Power Analysis

	Displays power profile against time
Frequency range	1 to 1.05 GHz
Dynamic range	60 dB below spectrum analyzer reference level
Scale (power)	10 dB/div
Scale (time)	50 μ s/div to 5 s/div
Trigger level	Adjustable over full dynamic range +ve or -ve trigger
Pre-trigger	0, 25%, 50%, 75% or 100% of displayed period

GENERAL INFORMATION

Modulation Meter

Sensitivity	Autotuned: 5 mW (N-Type) 0.05 mW BNC (antenna port) Manual Tuned: -34 dBm (N-Type) -60 dBm BNC (antenna port) Auto or manual control of input attenuator
-------------	--

Audio Filters

Lowpass Filters	Four independently configurable Lowpass filters LP1, LP2, LP3, LP4 that can be set to any frequency cut-off point from 250 Hz to 20,000 Hz (excluding the band 1001 to 2999 Hz). A 50 kHz Lowpass (No filters applied). 750 μ s de-emphasis.
Highpass Filters	50 Hz Highpass 300 Hz Highpass
Bandpass Filters	Any combination of LP1, LP2, LP3, LP4 and the Highpass filters.

Amplitude Modulation

Frequency Range	400 kHz to 1.05 GHz
Modulation Frequency Range	10 Hz to 15 kHz
AM Depth Range	0 to 99 % (manually tuned) 0 to 90 % below 100 MHz 0 to 80 % from 100 to 400 MHz Peak hold facility
Resolution	1% AM
Indication	2 digits and bargraph
Accuracy †	$\pm 5\% \pm 1$ digit at 1 kHz $\pm 8.5\% \pm 1$ digit 50 Hz to 10 kHz
Demodulation distortion	Less than 2 % at 1 kHz and 30 % AM (CCITT weighted)
Residual AM	Less than 1 % (300 Hz to 3.4 kHz)

Frequency Modulation

Frequency Range	400 kHz to 1.05 GHz
Modulation Frequency Range	10 Hz to 15 kHz
Deviation Range	0 to 75 kHz peak
Resolution	10 Hz below 2 kHz deviation, 1% above 2 kHz deviation
Indication	3 digits and bargraph
Accuracy †	$\pm 5\% \pm$ resolution at 1 kHz modulation frequency $\pm 7.5\% \pm$ resolution 50 Hz to 10 kHz
Demodulation distortion	Less than 2 % at 1 kHz and 5 kHz FM (CCITT weighted)
Residual FM	Less than 30 Hz (300 Hz to 3.4 kHz)
Demodulation Output Socket	200 mV peak to peak $\pm 10\%$ per 1 kHz deviation

† At low modulation levels the residual AM / FM may become significant

GENERAL INFORMATION

RF spectrum analyzer

Frequency Range	400 kHz to 1.05 GHz		
Spans	Continuously variable, 1 kHz / division to 100 MHz / division 1,2,5,10 increments Start / Stop frequency entry		
Resolution Bandwidth	300 Hz, 3, 30, 300 kHz, 3 MHz		
Reference Level (top of screen)	-50 dBm to +52 dBm, 0.7 mV to 71 V		
Displayed dynamic range	80 dB		
Noise floor	Typically 75 dB below top of screen		
On screen linearity	Typically ± 2 dB ± 1 resolution (10 dB/div) (10 dB above the noise floor)		
Vertical resolution	0.1 dB on 2 dB / division 0.5 dB on 10 dB / division		
Level Flatness	± 2 dB \pm resolution (10 dB/division)		
Intermodulation Distortion	Better than 70 dB for two signals at -30 dBm into first mixer		
Sweep speeds	10 ms/div to 200 ms/div in a 1, 2, 5 sequence (optimum sweep speed and bandwidth selected according to span)		
	SPAN	RES B/W	UPDATE
	10 kHz	300 Hz	5 SWEEP/sec
	100 kHz	3 kHz	9 SWEEP/sec
	1 MHz	30 kHz	9 SWEEP/sec
	10 MHz	300 kHz	9 SWEEP/sec
	100 MHz	300 kHz	5 SWEEP/sec
	1000 MHz	3 MHz	5 SWEEP/sec
Marker Indication	Level and frequency or delta marker from center line of screen Single marker for frequency and level display Marker to center frequency marker		
Features	Simultaneous 'Look and Listen' Span 100 kHz, 200 kHz, 500 kHz, 1 MHz		
Sensitivity	2 μ V		
Tracking Generator Offset/Frequency Range	0-999 MHz/400 kHz to 1 GHz		

Audio generators**Frequency**

Frequency Range	5 Hz to 33 kHz
Wave shape	Sine or square
Setting	Keyboard entry, delta increment / decrement function and rotary control
Indication	5 digits
Resolution	0.1 Hz below 3.25 kHz 1 Hz above 3.25 kHz
Accuracy	0.01 Hz <180 Hz 0.1 Hz >180 Hz

Level

Range	0.1 mV to 4 V RMS
Setting	Keyboard entry, delta increment / decrement function and rotary control
Indication	4 digits
Resolution	0.1 mV below 409 mV 1 mV above 409 mV
Accuracy	±5% ±resolution 50 Hz - 15 kHz
Output impedance	Nominally 5 Ω (Minimum load impedance 25 Ω)
Distortion	Less than 0.5 % at 1 kHz Less than 1 % from 50 Hz to 15 kHz

Signaling Encoder / Decoder

Sequential Tones Functions	Sequential tones functions including revert User defined tones Encodes and decodes up to 40 tones. CCIR, ZVEI, DZVEI, EEA, EIA or user defined. Any of the tones may be extended. Continuous, burst and single step modes available.
User Defined Tones	Up to two sequential tones frequency plans may be defined and stored within the Service Monitor. Any of the standard tone frequency plans may be copied to user defined and modified. Tone length 20 ms to 20 s Standard tone frequencies may be selected from a menu
DTMF	Generation and decoding of DTMF tones
DCS	Generation and decoding of Digitally Coded Squelch, DCS
POCSAG	Generation of POCSAG code CCIR No. 1 Rec 584. Bit rates from 400 to 4800 bit/s. Inversion available.
Audio Monitor	Demodulated signals and audio signals may be monitored via the internal loudspeaker and via the accessory socket output on the front panel.

GENERAL INFORMATION

Cellular and trunking

Test Modes

Auto test/manual test

Auto Test Programs (dependent upon which system is in use)

Call processing only
Call and RF testing
Brief testing
Comprehensive testing

Parametric Auto Test Routines

AF frequency	AF Level
FM deviation	Mod frequency
Rx distortion	Rx expansion
Rx sensitivity	Rx SINAD
Rx S/N	Tx compression
Tx distortion	Tx frequency
Tx level	Tx power level
Tx limiting	Tx mod level
Tx noise	Tx SINAD
Tx S/N	

Signaling Auto Test Routines

Registration/roaming update	PTT on
Place call	PTT off
Page mobile	SAT deviation
Clear from land	SAT frequency
Clear from mobile	ST duration
Handoff	ST frequency
Hook flash	ST deviation
DTMF decode	DSAT deviation
Data performance	

Frequency standard

Internal Frequency Standard (OCXO)

Frequency	10 MHz
Temperature stability	Better than 5 parts in 10^8 , 0 to 55°C
Ageing Rate	Better than 1 part in 10^7 per year, after 1 month's continuous use.
Warm up time	Less than 10 minutes to within 2 parts in 10^7 at 20°C

External Frequency Standard Input

Frequency	1, 2, 5 and 10 MHz
Input Level	Greater than 1 V peak to peak
Input Impedance	Nominally 1 k Ω

General

General features

Keyboard and Display`	Logical color-coded keyboard with bright high resolution LCD	
Display size	160 x 85 mm	
RS232C	RS232C interface is provided for printing or remote Service Monitor control.	
Connector	9 way female 'D' Type	
Power Requirements		
AC Supply Voltage	100 to 240V~ (limit 90 V to 264 V~)	108 to 118V~ (Limit 98 V to 132 V~)
AC Supply Frequency	50 to 60 Hz (limit 45 Hz to 66 Hz)	50 to 400 Hz (limit 45 Hz to 440 Hz)
Maximum AC Power	190 VA	
DC Supply Voltage	11 to 32V	
Maximum DC Power	100 W	
Calibration Interval	2 Years	
Electro-Magnetic Compatibility	<p>Conforms with the protection requirements of the EC Council Directive 2004/108/EC</p> <p>Conforms with the limits specified in the following standards: IEC/EN 61326-1 : 1997 + A1 : 1998 + A2 : 2001 + A3 : 2003, RF Emission Class B, Immunity Table 1, Performance Criterion B</p>	
Safety	<p>Conforms with the requirements of EC Council Directive 2006/95/EC (as amended) and the product safety standard IEC/EN 61010-1 : 2001 + C1 : 2002 + C2 : 2003 for Class 1 portable equipment, for use in a Pollution Degree 2 environment. The instrument is designed to operate from an Installation Category 2 supply.</p>	
Environmental		
Rated range of use	0°C to +55°C and up to 95% relative humidity at 40°C	
Storage and transport		
Temperature	-30°C to +71°C	
Altitude	Up to 2500m (pressurized freight at 27 kPa differential)	
Dimensions and Weight		
Standard dimensions		
Height	178 mm (7 inches)	
Width	380 mm (15 inches)	
Depth	457 mm (18 inches) (including handle, feet and covers)	
Weight	Less than 12 kg (Less than 27 lb) with no options fitted	

Options and accessories

Options

Option 1	600 Ω Matching Unit	
Option 2	Analog Systems Card	
Option 4	Parallel Interface †	
Option 5	GPIB Interface †	
Option 6	Memory Card Drive and Date/Time Stamp	
Option 8	SSB Demodulator	
Option 9	Occupied Bandwidth	
Option 10	NMT	} Require Option 2 to be fitted
Option 11	AMPS	
Option 12	TACS	
Option 13	MPT1327	
Option 14	PMRTEST	
Option 15	EDACS Radio Test	
Option 16	EDACS Repeater Test	
Option 22	POCSAG decode	
Option 23	CCITT Filter ‡	
Option 24	CMESS Filter ‡	
Option 25	Avionics	
Option 26	Tones Remote	
Option 29	Plus 2 Distortion Notch Filters board	
Option 30	Bail arm and front panel stowage cover	
Option 31	IF Output Capability	

† Option 4 and Option 5 cannot both be fitted.
 ‡ Option 23 and Option 24 cannot both be fitted.

600 Ω Matching Unit (Option 1)

Features Switchable 600 Ω balanced AF input and output
 Switchable 20 dB attenuator on AF generator output †

Input circuit

Impedance:	600 Ω
Return loss:	>21 dB at 1 kHz
Frequency response:	±0.5 dB at 200 Hz to 5 kHz, ±2 dB at 100 Hz to 20 kHz
Accuracy of 1:1 input:output ratio:	±1% at 1 kHz ± accuracy of 2948B
Maximum input:	5 V RMS maximum at 200 Hz to 5 kHz, 3 V RMS maximum at 100 Hz to 20 kHz

Output circuit

Impedance:	600 Ω
Return loss:	>21 dB at 1 kHz
Frequency response:	±0.5 dB at 200 Hz to 5 kHz, ±2 dB at 100 Hz to 20 kHz
Level accuracy:	±2% at 1 kHz ± accuracy of 2948B
Output level:	1 mV to 2.5 V RMS across 600 Ω.

† The 20 dB attenuator facility reduces the AF output resolution to 0.01 mV up to 40 mV output level.
 The accuracy of the output level degrades by ± 2 %

Analog Systems Card (Option 2)

Required for Options 10 to 16.
 For performance data refer to respective handbook supplement.

GENERAL INFORMATION

Parallel Interface (Option 4)	Allows direct connection of a parallel printer. Additionally provides 4 software programmable output lines.		
Printer port			
Connector	25 way female D-type		
Printers supported	75,100,150 dots per inch laser printers FX80, FX100 Epson format.		
Accessory port			
Connector	9 way female D-type		
Outputs	4 independently programmable output lines, each one configurable as a logic line or as a relay contact closure. +5V supply available.		
GPIB (Option 5)	For remote control of the Service Monitor.		
Capability	Complies with the following subsets defined by IEEE488:- SH1, AH1, T6, L4, SR1, RL1, E1, DC1, DT0		
Memory Card Drive and Real Time Clock (Option 6)	The memory card facility allows the storage of results, set-ups, screen dumps and user programs. Meets PCMCIA 2 standard. Allows the current date and time to be stored with results to the memory card and/or printed with a screen dump.		
SSB Demodulator (Option 8)	The SSB demodulator allows signals to be demodulated either via the internal loudspeaker or via the accessory socket. Provides demodulation of SSB signals (upper and lower sideband.)		
Frequency range	400 kHz to 1 GHz		
AF demodulation range	10 Hz to 15 kHz		
Distortion	Typically less than 3% at 1 kHz (300 Hz to 3.4 kHz)		
Detection range	2 μ V to 150 W		
Features	Automatic detection of USB or LSB. BFO can be used for tuning of carrier for AM and FM radios.		
Occupied Bandwidth (Option 9)	Calculates the bandwidth of a signal displayed on the spectrum analyzer.		
Frequency range	1 MHz to 1 GHz		
Displayed resolution	3 digits		
Accuracy	20%		
Bandwidth measurement range	3 kHz minimum		
Ratio range	90% to 99%, selectable in 0.1% steps		
NMT Cellular Software (Option 10)	NMT 450	NMT 900	
	Benelux	NMTF	
	Austria	Spain	
	Malaysia	Indonesia	
	Saudi 1	Saudi 2	
	Thailand	Oman	
	Tunisia	Hungary	
	Poland	Russia	
	Czech	Bulgaria	
	Slovenia	Turkey	
	USER DEFINED NMT		
AMPS Cellular Software (Option 11)	E-AMPS N-AMPS USER DEFINED AMPS		
TACS Cellular Software (Option 12)	E-TACS C-TACS II USER DEFINED TACS	TACS 2 J-TACS	C-TACS I N-TACS
MPT 1327 Trunking Software (Option 13)	BAND III UK WATER AUTONET MADEIRA NZ MPT1327 USER DEFINED MPT	JRC HONG KONG AMT NL-TRAXIS PH-INDO	

GENERAL INFORMATION

PMRTEST Software (Option 14)	USER DEFINED PMR for FM radios
EDACSTM Radio Test Software (Option 15)	Provides Auto/Manual test capability for EDACS™ radios. Up to four user-defined variants can be created and stored, each with up to 24 spot-channel frequencies
EDACSTM Repeater Test Software (Option 16)	<p>Provides Auto/Manual test capability for EDACS™ repeaters. Up to four user defined variants can be created and stored, each with up to 24 spot-channel frequencies. A data logging facility is also available to continuously decode and display data messages from the repeater under test.</p> <p>EDACS is an Ericsson GE registered trademark.</p>
LTR Trunking Test Software (Option 18)	Provides Auto/Manual test capability for LTR Trunked radios
Pocsag Decode (Option 22)	Allows off-air decoding of POCSAG messages. Can decode a message as it is received, or decoding can be triggered from a user-selectable RIC code or fixed message pattern.
Bit Rate	Automatically decodes any standard bit rate up to 4800 bit/s. Numeric and Alphanumeric decoding is provided. Number of received errors is displayed.
CCITT (Option 23)	Allows a CCITT filter to be inserted into either the demodulated audio path or the audio input path
C-MESSAGE (Option 24)	Allows a CMESS filter to be inserted into either the demodulated audio path or the audio input path
Avionics (Option 25)	<p>The Avionics Systems provides amplitude modulated signals suitable for testing ILS, VOR, Marker Beacons and SELCAL</p> <p>Full details of the Avionics features can be found in the Option 25 data sheet , part number 46891/213</p>
Tone Remote Option 26)	Provides configuration screens and generation of Tone Remote control signals.
Plus 2 Distortion Notch Filters board (Option 29)	The standard instrument is supplied with a 1 kHz notch for Distortion and SINAD measurements. This option allows the user to carry out Distortion and SINAD measurements at two additional frequencies. The two additional notch frequencies can be anywhere in the band 50 Hz to 20 kHz and must be stipulated at the time of ordering.
Bail arm and front panel stowage cover (Option 30)	Provides a bail arm carrying handle and front panel cover and storage area. The bail arm will also provide additional viewing angles when mounted on a bench.
IF Output Capability (Option 31)	Allows access to the IF signal from the rear of the Instrument. (Note: Incorporation of this option replaces the standard demod out capability.)

GENERAL INFORMATION

Supplied Accessories

	AC Supply lead*
43138/755	DC Supply lead
46882/692	Operating Manual
46882/683	Programming Manual

*The AC supply lead provided with the Service Monitor will depend on the destination country. See *Power requirements, Power cords*, in chapter 2 of this manual

Optional Accessories

44991/145	Microphone with PTT
54431/023	20 dB AF attenuator (BNC)
46884/728	Rack Mounting Kit
54421/001	Antenna BNC
46662/779	Soft carrying case (suitable for all 2948/2948B)
46662/571	Soft carrying/operational case
46662/616	Soft carrying/operational case for use with Option 30
54112/163	Hard transit case
46880/115	Service Manual
54421/002	Directional Power Head 1 to 50 MHz
54421/003	Directional Power Head 25 to 1000 MHz
43130/590	1m 7 way DIN lead Assy
43130/591	3m 7 way DIN lead Assy
59999/170	RF Directional Bridge
59000/189	Memory Card (128kbyte)
59000/375	Memory Card (2Mbyte)
46884/648	Serial cable 9 way female to 25 way male
46884/649	Serial cable 9 way female to 25 way female
46884/650	Serial cable 9 way female to 9 way female
80013	Cable assembly N (m) to N (m), 2.5 m, double-screened

EC Declaration of Conformity

Certificate Ref. No.: DC256

The undersigned, representing:

Manufacturer: **Aeroflex International Ltd.**

Address: **Longacres House, Six Hills Way,
Stevenage, Hertfordshire, UK SG1 2AN**

Herewith declares that the product:

Equipment Description: **Communications Service Monitor**

Model No. **2948B**

Options: **1, 2, 4, 5, 6, 8, 9, 10, 11, 12, 13, 14, 15, 16, 18, 22, 23, 24, 25, 26, 29, 30, 31,
soft carrying/optional case and microphone**

is in conformity with the following EC directive(s)
(including all applicable amendments)

Reference No.	Title:
2006/95/EC	Low Voltage Directive
2004/108/EC	EMC Directive

and that the standards and/or technical specifications referenced below have been applied:

Safety:

Designed to:
IEC/EN 61010-1 : 2001 + C1 : 2002 + C2 : 2003

EMC:

IEC/EN 61326-1:1997 + A1 : 1998 + A2 : 2001+ A3 : 2003
RF Emission Class B, Immunity Table 1 and Performance Criterion B

Qualifying Notes:

Aeroflex Stevenage (Place)

3 September 2007 (Date)



(Signature)

Richard Dickens - Quality Manager

Chapter 2 INSTALLATION

Contents

Introduction.....	2-2
Initial visual inspection of new Service Monitors.....	2-2
Ventilation	2-2
Operational case (46662/571) shoulder strap.....	2-2
Bail arm option	2-3
Power requirements	2-3
Fuses	2-3
Class I power cords (3-core).....	2-3
Connecting to a DC supply	2-6
RF and AF connections.....	2-6
Accessory socket connections.....	2-7
Remote control connections.....	2-8
RS232	2-8
GPIB	2-9
Self tests.....	2-10
Positioning the Service Monitor for use	2-11
Routine maintenance.....	2-11
Ventilation fan and filter.....	2-11
Routine safety testing and inspection.....	2-12
1. Visual inspection	2-12
2. Earth bonding tests	2-12
3. Insulation tests	2-13
4. Rectification.....	2-13
Cleaning.....	2-13

List of tables

Table 2-1 Accessory socket pin numbering, location and functions.....	2-7
Table 2-2 Accessory socket logic and applications	2-8

List of figures

Fig. 2-1 Preventing strap buckle from slipping.....	2-2
Fig. 2-2 Accessory in/out socket pin numbers	2-7
Fig. 2-3 RS232 serial port connections	2-8
Fig. 2-4 Null modem connections.....	2-9
Fig. 2-5 IEEE488 parallel port connections.....	2-9

Introduction

This chapter deals with preparing the Service Monitor for use for the first time and with the checks to be made when the Service Monitor may have been used under unknown conditions.

The latter situation could well apply where the Service Monitor is used by several users for differing tasks.

Initial visual inspection of new Service Monitors

After unpacking the Service Monitor and before making any connections to a power source, inspect for any signs of mechanical damage.

Ventilation

The Service Monitor is force cooled by a fan located in the rear panel. The cooling air is drawn into the Service Monitor through the fan and expelled through ventilator grills located on the right and on the underside. An air filter over the fan inlet prevents the ingress of dust and other particles.

CAUTION

The Service Monitor requires an unrestricted airflow to ensure that its performance meets the specification. Before switching the Service Monitor on, check that the air inlet on the rear panel is not restricted and that there is no loose material close by which could be sucked into the fan. Refer to *Routine Maintenance* later in this chapter for details of cleaning and replacing the air filter.

The optional operational case has ventilation apertures which align with those of the Service Monitor. Ensure that these are not obstructed.

Operational case (46662/571) shoulder strap

The shoulder strap supplied with the operational case should be attached to the front handles of the Service Monitor. When fitting the strap, always loop the tails of the strap through the buckles in the reverse direction. This will prevent the strap from slipping through the buckle. See *Fig. 2-1 Preventing strap buckle from slipping*.

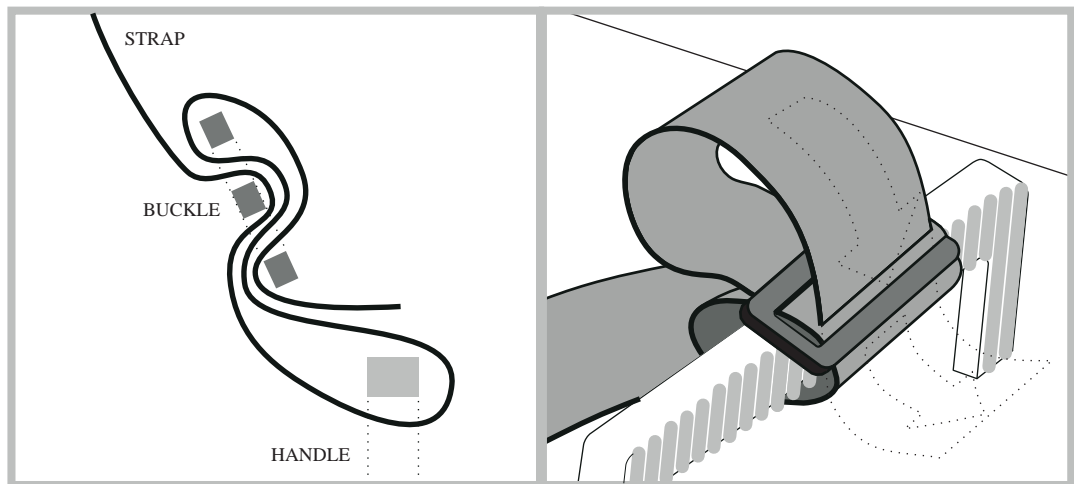

Fig. 2-1 Preventing strap buckle from slipping

Bail arm option

If the bail arm carrying handle is fitted, the Service Monitor will not fit into the optional operational case, 46662/571. Do not attempt to attach the shoulder strap supplied with this operational case to a Service Monitor fitted with a bail arm carrying handle.

Power requirements

The Service Monitor can be powered from both AC and DC power sources.

AC supplies must be within the range 100 to 240 V~, at a frequency of between 50 and 60 Hz; or within the range 108 to 118 V~, at a frequency of between 50 and 400 Hz. The maximum power consumption is 190 VA. Voltage selection is not necessary as the AC power supply module within the Service Monitor is designed to handle this wide spread of input variations. For DC operation, the Service Monitor requires a supply within the range 11 to 32 V. The maximum DC power requirement is 100 W.

Fuses

The AC input circuit is fed through a single fuse fitted to the rear panel of the Service Monitor, within the AC input connector. This should be a 2 A anti-surge, 5 × 20 mm glass cartridge fuse, type T2AL250V.

The DC input circuit is also fed through a single fuse fitted to the rear panel of the Service Monitor. This should be a 10 A anti-surge, 5 × 20 mm glass cartridge fuse, type T10AH250V.

Class I power cords (3-core)

General

When the equipment has to be plugged into a Class II (ungrounded) 2-terminal socket outlet, the cable should either be fitted with a 3-pin Class I plug and used in conjunction with an adapter incorporating a ground wire, or be fitted with a Class II plug with an integral ground wire. The ground wire must be securely fastened to ground. Grounding one terminal on a 2-terminal socket will not provide adequate protection.

In the event that a molded plug has to be removed from a lead, it must be disposed of immediately. A plug with bare flexible cords is hazardous if engaged in a live socket outlet.

The instrument is a Safety Class 1 product and therefore must be earthed. Use the supplied power cord or an appropriate replacement. Make sure that the instrument is plugged into an outlet socket with a protective earth contact.

Disconnecting device

The detachable power cord is the instrument's disconnecting device, but if the instrument is integrated into a rack or system, an external power switch or circuit breaker is required. Whatever the disconnecting device, make sure that you can reach it easily and that it is accessible at all times.

Power cords with the following terminations are available. Please check with your local sales office for availability.

INSTALLATION

This equipment is provided with a 3-wire (grounded) cordset which includes a molded IEC 60320-1 connector for connection to the equipment. The cable must be fitted with an approved plug which, when plugged into an appropriate 3-terminal socket outlet, grounds the case of the equipment. Failure to ground the equipment may expose the operator to hazardous voltage levels. Depending upon the destination country, the color coding of the wires will differ:

British

Country	IEC 60320-1 plug	Part number
United Kingdom	Straight through	23422/001
United Kingdom	Right angled	23422/002

The UK lead is fitted with an ASTA approved molded plug to BS 1363.

A replaceable 13 A fuse to BS 1362 is contained within the plug. This fuse is only designed to protect the lead assembly. Never use the plug with the detachable fuse cover omitted or if the cover is damaged.

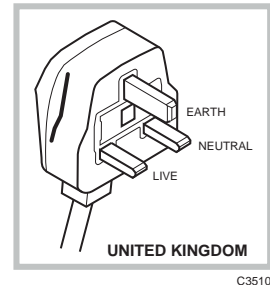

C3510

The fuse(s) or circuit breaker to protect the equipment is fitted at the back of the equipment.

North American

Country	IEC 60320-1 plug	Part number
North American	Straight through	23422/004
North American	Right angled	23422/005

The North American lead is fitted with a NEMA 5-15P (Canadian CS22.2 No 42) plug and carries approvals from UL and CSA for use in the USA and Canada.

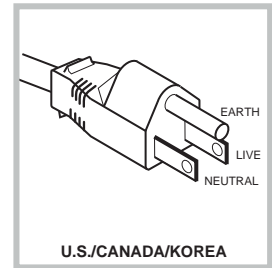

C3511

Continental Europe

Country	IEC 60320-1 plug	Part number
Europe	Straight through	23422/006
Europe	Right angled	23422/007

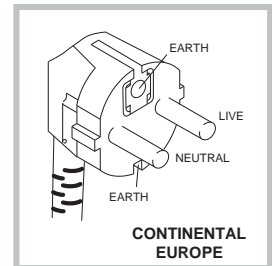

C3512

The Continental European lead is fitted with a right angle IEC83 standard C4 plug (CEE 7/7) which allows it to be used in sockets with either a male earth pin (standard C 3b) or side earth clips (standard C 2b) the latter is commonly called the German 'Schuko' plug. In common with other Schuko style plugs, the plug is not polarized when fitted into a Schuko socket. The lead carries approvals for use in Austria, Belgium, Finland, France, Germany, Holland, Italy, Norway and Sweden. Note that this plug will not fit Italian standard CEI 23-16 outlets. The lead should not be used in Denmark given that the earth connection will not be made.

Français

Le câble d'alimentation d'Europe Continentale est muni d'un connecteur mâle à angle droit type CEI83, standard C4 (CEE 7/7), qui peut être utilisé dans une prise femelle à ergot de terre (standard C 3b) ou à clips latéraux (standard C 2b), cette dernière étant communément appelée prise "Schuko" allemande. De la même façon que les autres connecteurs de type Schuko, celui-ci n'est pas polarisé lorsqu'il s'adapte à une prise femelle Schuko. Ce câble d'alimentation est homologué en Allemagne, Autriche, Belgique, Finlande, France, Hollande, Italie, Norvège et Suède. A noter que ce connecteur n'est pas compatible avec les prises de courant italiennes au standard CEI 23-16. Ce câble ne doit pas être utilisé au Danemark à cause du défaut de connexion de masse.

Deutsch

Das kontinentaleuropäische Netzkabel ist mit einem rechtwinkligen Stecker nach IEC83 C4 (CEE7/7) Standard versehen, welcher sowohl in Steckdosen mit Erde-Stift (Standard C 3b) oder seitlichen Erdeklemmen, im allgemeinen "Schukosteckdose" genannt, paßt. Üblicherweise ist der Schukostecker bei Verwendung in Schukosteckdosen nicht gepolt. Dieses Netzkabel besitzt Zulassung für Österreich, Belgien, Finnland, Frankreich, Deutschland, Holland, Italien, Norwegen und Schweden.

Hinweis: Dieser Schukostecker paßt nicht in die italienischen Standardsteckdosen nach CEI 23-16 Norm. Dieses Netzkabel sollte nicht in Dänemark verwendet werden, da hier keine Erdeverbindung hergestellt wird.

Español

El cable de alimentación tipo Europeo Continental dispone de una clavija C4 normalizada IEC83 (CEE 7/7) que permite su utilización tanto en bases de enchufe con toma de tierra macho (tipo C 3b) o con toma de tierra mediante contactos laterales (tipo C 2b) que, en este último caso, suele denominarse "Schuko". Al igual que cualquier otra clavija tipo Schuko, las conexiones a red no están polarizadas cuando se conectan a una base tipo Schuko. El cable lleva autorización para su uso en Austria, Bélgica, Finlandia, Francia, Alemania, Holanda, Italia, Noruega y Suecia. Observe que este cable no se adapta a la norma italiana CEI 23-16. El cable no debe utilizarse en Dinamarca en el caso de no efectuarse conexión a tierra.

Italiano

I cavi d'alimentazione per l'Europa continentale vengono forniti terminati con una spina ad angolo retto del tipo C4 secondo lo standard IEC83 (CEE 7/7) che può essere usato in prese in cui la terra può essere fornita o tramite connettore maschio (C 3b) o tramite clips laterali (C 2b), quest'ultima comunemente detta di tipo tedesca "Schuko". Questa spina, quando collegata ad una presa Schuko, non è polarizzata.

Il cavo può essere usato in Austria, Belgio, Finlandia, Francia, Germania, Olanda, Norvegia, Svezia ed Italia. E' da notare che per l'Italia questo non risponde allo standard CEI 23-16.

Questa spina non dovrebbe invece essere usata in Danimarca in quanto non realizza il collegamento di terra.

Connecting to a DC supply

If the Service Monitor is to be used from a DC voltage source it should be connected using the supplied DC connecting lead. The polarity of the connections must be correct, RED to POSITIVE, BLACK to NEGATIVE.

The negative connection of the DC supply is directly connected to the chassis of the Service Monitor and therefore to all screen connections of input and output connectors. Note however, that the AF ports are isolated under some operating conditions.

The Service Monitor will function from any supply with a voltage within the range given under *Performance data, Power requirements*, in chapter 1. Note that the supply must be capable of delivering a current in the order of 9 amps at the lowest voltage.

Ensure that the supply lead connections are sound and cannot short together.

If the DC supply powering the Service Monitor falls to a level close to the lower limit of the input voltage range, a warning **BATT** is displayed on the screen.

RF and AF connections

All RF and AF connections should be made using good quality connectors correctly fitted to appropriate cable. All connectors should be locked to the Service Monitor using the bayonet or threaded locking rings. Do not use leads that have damaged connectors or cable as this can cause poor performance and might damage the Service Monitor.

RF leakage levels in a test set-up can be aggravated by the use of poor quality connector leads. A double screened lead, 1 meter in length and terminated with male BNC connectors, Part No 43137/052 and a 1 meter, 'N type' male to 'N type' male, connector lead 54311/095 are both available from Aeroflex sales offices.

WARNING

Hot Surfaces

Take care when touching the RF Input Type N connector after the application of high levels of continuous power. If 50 W is exceeded for a prolonged period, the temperature of the connector can become excessive.

Accessory socket connections

The accessory socket located on the front panel, is of the 7 pin DIN, 45° configuration. The function of each of the pins on this socket is shown in the following table. The pin numbering is shown in *Fig. 2-2 Accessory in/out socket pin numbers*, and is as viewed from the front of the Service Monitor.

Table 2-1 Accessory socket pin numbering, location and functions

Din pin No	Function
6	Logic
1	Mic input/PTT-logic
4	Forward power
2	12 V DC at approx. 100 mA
5	Reverse power
3	Logic
7	Loudspeaker output

The pin numbering of the Accessory socket, as seen from the front of the Service Monitor, is shown in *Fig. 2-2 Accessory in/out socket pin numbers*.

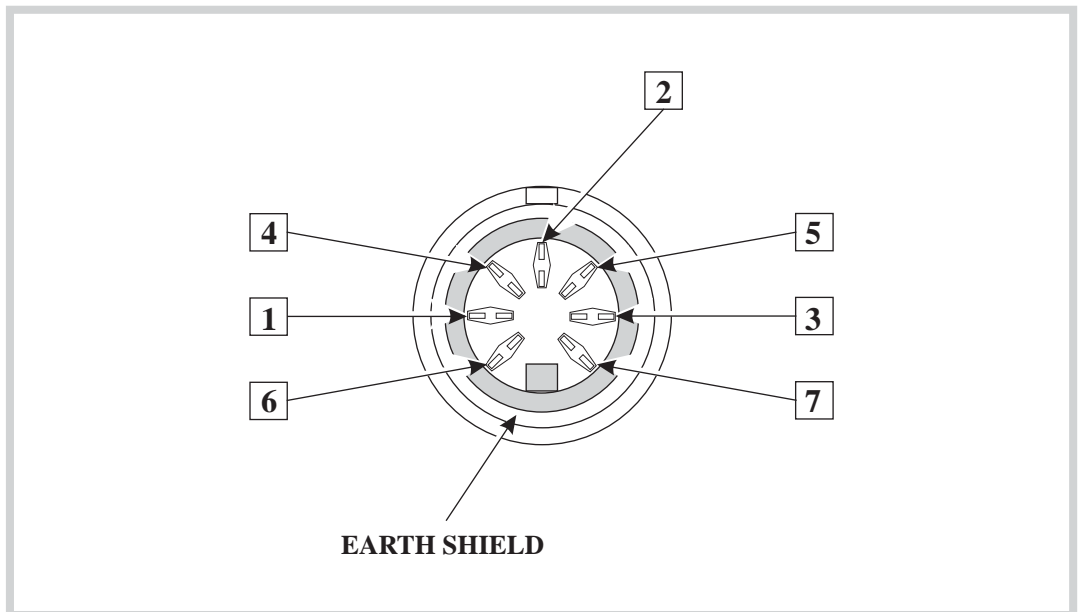

C1785

Fig. 2-2 Accessory in/out socket pin numbers

The socket is used for connecting dedicated accessories such as directional power heads and microphones with press to talk switching capabilities.

INSTALLATION

Selection logic [or data signals] on pins 1, 3 and 6 enables the Service Monitor to recognize the connections of an external accessory. The appropriate pins are at TTL levels and are active low as shown below:

Table 2-2 Accessory socket logic and applications

Accessory	Pin 1	Pin 3	Pin 6
Nothing connected	High	High	High
Microphone (press to talk)	low	high	high
External power: Auto zero	High	Low	Low
External power: Peak power	High	High	Low
External power: CW power	High	Low	High

Refer to chapter 3, *Operation*, for details of using the socket.

A 3.0 meter lead assembly (part No. 43130/591) is available as an optional accessory.

Remote control connections

RS232

The serial port connection requires a 9 way female 'D' Type connector. This should be correctly fitted to the appropriate cable and the locking screws should be used to prevent undue strain from being applied to the connector housing.

The pin connections are listed below and the pin locations shown in *Fig. 2-3 RS232 serial port connections (as seen facing panel)*.

Contact	Function	Contact	Function
1	Not connected	6	DSR
2	Rx data in	7	RTS
3	Tx data out	8	CTS
4	DTR	9	Not connected
5	Ground		

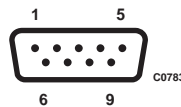
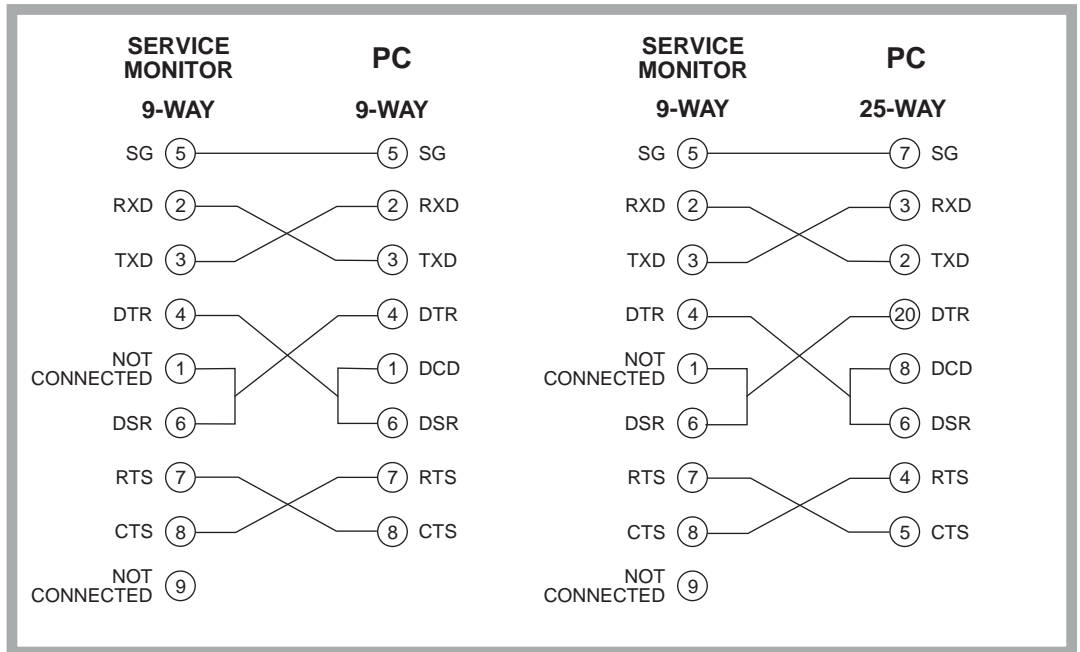

Fig. 2-3 RS232 serial port connections (as seen facing panel)

The use of a NULL MODEM cable assembly is required for connecting to control equipment such as PCs.

The connections for 9 way to 9 way and 9 way to 25 way versions are shown in *Fig. 2-4*.

INSTALLATION



C3383

Fig. 2-4 Null modem connections

GPIB

When the optional GPIB interface unit has been fitted, connections are made to it using a 24-way IEEE 488 male connector. If a stackable connector is used in order to interconnect more than two pieces of equipment, ensure that no physical damage to the Service Monitor connector will result. The pin connections are listed below and the pin locations shown in *Fig. 2-5 IEEE488 parallel port connections (as seen facing panel)*.

Contact	Function	Contact	Function
1	Data I/O 1	13	Data I/O 5
2	Data I/O 2	14	Data I/O 6
3	Data I/O 3	15	Data I/O 7
4	Data I/O 4	16	Data I/O 8
5	EOI	17	REN
6	DAV	18	Pair with 6
7	NRFD	19	Pair with 7
8	NDAC	20	Pair with 8
9	IFC	21	Pair with 9
10	SRQ	22	Pair with 10
11	ATN	23	Pair with 11
12	Ground shield	24	Logic ground

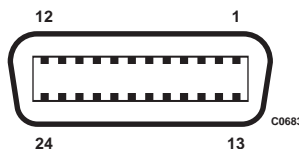

Fig. 2-5 IEEE488 parallel port connections (as seen facing panel)

Self tests and acceptance tests

The service monitor incorporates a self test program which allows users to verify its condition at any time. This program is described below.

When it is necessary to prove that the performance of the Service Monitor meets the published performance data, the *Acceptance tests*, described in Chapter 5, should be carried out.

Self tests

The built in Self Test program measures the output parameters of the RF generator using the transmitter test functions. The RF generator output is coupled internally and no external connections are required.

The self test program is accessed through the help/set-up menu and consists of 17 tests, which are listed on the display when the [*Self Test*] key is pressed.

Before running the program, the Service Monitor should be reset to the factory preset state. This is done by pressing the [MEM] key, to display the STORE/RECALL screen and menu. The message '*Recall Store No*' is shown. Key in and enter the digits '01'. The Service Monitor will now be ready to run the self test program.

To run the program the [*GO*] key is pressed and the tests are carried out consecutively. The legend 'ACTIVE' is displayed against each test as it is carried out, which changes to 'PASS' or 'FAIL' as each test is completed. If a particular test fails, the reason is given alongside the 'FAIL' legend, together with the measurement.

The tests carried out, the related set-ups and the functions verified are listed below.

Test No 1	Broadband power. 500 MHz
Test No 2	Transmitter Frequency. 500 MHz
Test No 3	Broadband power. 1 GHz
Test No 4	Transmitter Frequency. 1 GHz
Test No 5	Broadband power. 10 MHz
Test No 6	Transmitter Frequency. 10 MHz

The above tests compare the generated power and frequency against the broadband power meter and the frequency meter at each of the frequencies specified.

Related set-up. Manual tune

The functions verified by the above tests are:-

Signal generator frequency and level accuracy.

Power meter accuracy.

Test No 7 to 14

Narrow band power meter. Power level +10 dBm. (Test No 7) to -60 dBm. (Test No 14)

These tests compare the generated power levels against the narrowband power meter readings.

Related set-ups. Frequency, 10 MHz, IF Bandwidth, 30 kHz.

The functions verified by the above tests are:-

Signal generator level accuracy.

Signal generator attenuators.

Spectrum analyzer level accuracy.

Receiver attenuators.

Test No 15 FM deviation. 50 kHz

This test checks the signal generator FM deviation against the modulation meter reading.

Related set-ups. Frequency 10 MHz, level -26 dBm, IF bandwidth 300 kHz, audio bandwidth 0.3 - 3.4 kHz, FM demodulation.

The functions verified by the above tests are:-

Signal generator FM accuracy, modulation meter FM accuracy, modulation generator (audio generator) level accuracy.

Test No 16 Modulation frequency. 1 kHz.

This test checks the modulation generator output frequency against the audio counter reading.

Related set-ups. Frequency 10 MHz, level -26 dBm, IF bandwidth 300 kHz, audio bandwidth 0.3 - 3.4 kHz, FM demodulation.

The functions verified by the above tests are:-

Modulation generator (audio generator) frequency accuracy.

Test No 17 AM Depth. 50%

This test checks the signal generator AM against the modulation meter reading.

Related set-ups. Frequency 10 MHz, level -26 dBm, IF bandwidth 0.3 - 3.4 kHz, AM demodulation.

The functions verified by the above tests are:-

Signal generator AM accuracy, modulation meter AM accuracy, audio generator frequency accuracy, audio generator level accuracy, audio filters, audio counter.

Positioning the Service Monitor for use

The monitor can be used as a bench instrument, either flat standing or inclined using the elevating front feet. Refer to the caution relating to *Tilt facility* in the preface to this manual. The monitor can also be used as a field service instrument while left in the operational case. It can be operated in any position convenient to the operator. Note that if the Service Monitor is supplied with the non-operational soft carrying case that has no ventilation apertures, the Service Monitor must be removed from the case before operating. See the **Caution** under *Ventilation* in this chapter.

Routine maintenance

Ventilation fan and filter

The ventilator fan on the rear of the Service Monitor is fitted with a filter to prevent the ingress of foreign matter into it. This should be inspected and cleaned at regular intervals. The procedure for this is as follows:-

Disconnect the Service Monitor from the mains supply and from any DC supply.

Remove any other connections to the Service Monitor.

WARNING

Failing to disconnect the power source before removing the filter could result in the fan becoming switched on accidentally.

Stand the Service Monitor face down on a firm, non-scratch flat surface so that it is supported on the front handles.† The rear of the Service Monitor, with the fan housing, should be at a safe and accessible working height.

Remove the two M4 screws holding the fan filter to the rear of the Service Monitor and lift the filter away.

Take the filter to a suitably ventilated location and remove as much dust and other foreign matter as is practical. Do not wet or wash the filter.

Refit the filter to the Service Monitor, using the reverse procedure as appropriate.

If the filter is damaged or blocked, a replacement is available as part no. 35907/675.

† If the bail arm carrying handle has been fitted, this should be positioned over the top of the Service Monitor before standing it face down, supported on the front bumpers.

Routine safety testing and inspection

In the UK the 'Electricity at Work Regulations' (1989) section 4(2) places a requirement on the users of equipment to maintain it in a safe condition. The explanatory notes call for regular inspections and tests together with a need to keep records.

The following electrical tests and inspection information is provided for guidance purposes and involves the use of voltages and currents that can cause injury. It is important that these tests are only performed by competent personnel.

Prior to carrying out any inspection and tests the Service Monitor must be disconnected from the mains supply and all external signal connections removed. All tests should include the Service Monitor's own supply lead, all covers must be fitted and the supply switch must be in the 'ON' position.

The recommended inspection and tests fall into three categories and should be carried out in the following sequence:

1. Visual inspection
2. Earth Bonding Test
3. Insulation Resistance test.

1. Visual inspection

A visual inspection should be carried out on a periodic basis. This interval is dependent on the operating environment, maintenance and use, and should be assessed in accordance with guidelines issued by the Health and Safety Executive (HSE). As a guide, this Service Monitor, when used indoors in a relatively clean environment, would be classified as 'low risk' equipment and hence should be subject to safety inspections on an annual basis. If the use of the equipment is contrary to the conditions specified, you should review the safety re-test interval.

As a guide, the visual inspection should include the following where appropriate:

Check that the equipment has been installed in accordance with the instructions provided (e.g. that ventilation is adequate, supply isolators are accessible, supply wiring is adequate and properly routed).

The condition of the mains supply lead and supply connector(s).

Check that the mains supply switch isolates the Service Monitor from the supply.

The correct rating and type of supply fuses.

Security and condition of covers and handles.

Check the supply indicator functions (if fitted).

Check the presence and condition of all warning labels and markings and supplied safety information.

Check the wiring in re-wireable plugs and appliance connectors.

If any defect is noted this should be rectified before proceeding with the following electrical tests.

2. Earth bonding tests

Earth bonding tests should be carried out using a 25A (12V maximum open circuit voltage) DC source. Tests should be limited to a maximum duration of 5 seconds and have a pass limit of 0.1 Ω after allowing for the resistance of the supply lead. Exceeding the test duration can cause damage to the equipment. The tests should be carried out between the supply earth and exposed case metalwork, no attempt should be made to perform the tests on functional earths (e.g. signal carrying connector shells or screen connections) as this will result in damage to the equipment.

3. Insulation tests

A 500 V DC test should be applied between the protective earth connection and combined live and neutral supply connections with the equipment supply switch in the 'on' position. It is advisable to make the live/neutral link on the appliance tester or its connector to avoid the possibility of returning the Service Monitor to the user with the live and neutral poles linked with an ad-hoc strap. The test voltage should be applied for 5 seconds before taking the measurement.

Aeroflex employs reinforced insulation in the construction of its products and hence a minimum pass limit of 7 M Ω should be achieved during this test.

Where a DC power adapter is provided with the Service Monitor the adapter must pass the 7 M Ω test limit.

We do not recommend dielectric flash testing during routine safety tests. Most portable appliance testers use AC for the dielectric strength test which can cause damage to the supply input filter capacitors.

4. Rectification

It is recommended that the results from the above tests are recorded and checked during each repeat test. Significant differences between the previous readings and measured values should be investigated.

If any failure is detected during the above visual inspection or tests, the Service Monitor should be disabled and the fault should be rectified by an experienced Service Engineer who is familiar with the hazards involved in carrying out such repairs.

Safety critical components should only be replaced with equivalent parts, using techniques and procedures recommended by Aeroflex.

The above information is provided for guidance only. Aeroflex designs and constructs its products in accordance with International Safety Standards such that in normal use they represent no hazard to the operator. Aeroflex reserves the right to amend the above information in the course of continuing its commitment to product safety.

Cleaning

Before commencing any cleaning, switch off the Service Monitor and disconnect it from the supply. The exterior surface of the case may be cleaned using a soft cloth moistened in water. Do not use aerosol or liquid solvent cleaners.

Chapter 3

LOCAL OPERATION

Contents

About this chapter	3-3
Front panel layout	3-4
Rear panel controls and connectors	3-8
Getting started	3-9
(Applying power and selecting test modes)	3-9
Test mode screens and menus	3-9
HELP/SETUP	3-10
Bar charts	3-15
Spectrum analyzer	3-15
Oscilloscope	3-15
Using the test modes.....	3-16
Brief descriptions	3-16
Tx test (transmitter testing)	3-18
Overview	3-18
Connections	3-19
Setting up	3-20
Making measurements	3-27
External attenuators	3-34
Rx test (receiver testing)	3-39
Overview	3-39
Connections	3-40
Setting up	3-41
AF input level measurement	3-45
Making measurements	3-47
Dx test (duplex testing)	3-53
Overview	3-53
Systems	3-55
Spectrum analyzer	3-55
Overview	3-56
Setting up	3-56
AF test (audio frequency testing)	3-63
Overview	3-63
Setting up	3-63
Input level measurement	3-64
Input filtering	3-65
Distortion measurement	3-65
Incremental adjustment keys	3-68
General	3-68
Assigning	3-69
Use within spectrum analyzer mode	3-69
Tones	3-70
Tones sub-mode	3-70
Observing tones signals in other test modes	3-70
Signal routing	3-71
RF input attenuators	3-71
Sequential tones	3-72
Overview	3-72
Testing sequential tone receivers	3-72
Testing sequential tone transmitters	3-75

CTCSS	3-77
Output level	3-77
Tone selection	3-77
Tone frequency shift	3-77
DCS	3-79
Overview	3-79
DCS receiver decoder testing	3-79
DCS transmitter encoder testing	3-80
DTMF	3-81
Overview	3-81
Tx test DTMF tones function	3-81
Rx test DTMF tones function	3-82
Dx test DTMF tones function	3-83
AF test DTMF tones function	3-83
AF Tone Remote	3-84
Overview	3-84
Testing AF Tone Remote systems	3-84
POCSAG	3-85
Overview	3-85
Testing a radio pager	3-87
Decoding POCSAG type signals	3-88
Oscilloscope	3-89
Setting up	3-89
Expanded display	3-90
Stores, settings/results	3-91
Overview	3-91
STORE/RECALL	3-91
Storing	3-92
DISPLAY HOLD STORE	3-92
Other memory functions	3-92
Titling store locations	3-93
Memory card	3-94
Formatting memory cards	3-94
Accessing the memory cards	3-94
Write-protecting cards	3-95
Coded store protection	3-95
Storing on memory cards	3-96
Printing from memory cards	3-97
Error messages	3-98
Real time clock. Date and time stamping	3-99
Printer	3-100
Parallel printer port option	3-100

List of tables

Table 3-1 Parallel printer port connections	3-100
Table 3-2 Rear accessory port connections	3-102

List of figures

Fig. 3-1 Front panel.....	3-4
Fig. 3-2 Typical displays.....	3-5
Fig. 3-3 Rear panel layout, (with optional GPIB fitted).....	3-8
Fig. 3-4. AF Filter HELP/SETUP page.....	3-11
Fig. 3-5 Transmitter test connections.....	3-19
Fig. 3-6 Tx power, harmonic analysis screen.....	3-28
Fig. 3-7 Power Transient Analysis screen.....	3-29
Fig. 3-8 Transient Analysis displays.....	3-32
Fig. 3-9 Occupied Bandwidth display.....	3-33
Fig. 3-10 Distortion level and signal to noise level measurements.....	3-36
Fig. 3-11 Receiver test connections.....	3-40
Fig. 3-12 Selectivity test setup.....	3-50
Fig. 3-13 Spurious response 'Image Frequency' location.....	3-51
Fig. 3-14 One port duplex test setup.....	3-53
Fig. 3-15 Alternative two port duplex setups.....	3-54
Fig. 3-16 Spectrum analyzer test setup.....	3-55
Fig. 3-17 Spectrum analyzer test setup using the tracking generator.....	3-55
Fig. 3-18 Spectrum analyzer setup, Look and Listen function.....	3-60
Fig. 3-19 Audio test setup.....	3-63
Fig. 3-20 Tones selection screen and Tones mode receiver input level setting.....	3-70
Fig. 3-21 RF Sequential tones encoder display, main menu.....	3-73
Fig. 3-22 RF Sequential tones standard selection menu.....	3-73
Fig. 3-23 RF Sequential tones decoder screen.....	3-75
Fig. 3-24 RF CTCSS encoder screen and menu.....	3-77
Fig. 3-25 RF DCS ENCODER screen and menu.....	3-79
Fig. 3-26 RF DTMF DECODER screen and menu.....	3-81
Fig. 3-27. AF Tone Remote screen.....	3-84
Fig. 3-28 POCSAG radio pager test screen and menu.....	3-85
Fig. 3-29 Alternative address/warning messages.....	3-86
Fig. 3-30 Parallel printer port socket contacts.....	3-100
Fig. 3-31 Simplified diagram of rear accessory port switching.....	3-101
Fig. 3-32 Rear accessory port socket connections.....	3-102

About this chapter

This chapter deals with using the Communications Service Monitor as a 'stand alone' instrument and covers:

- The front panel layout with a brief description of all controls and connections.
- The connectors and occasional controls on the rear panel.
- An introduction to each of the test modes, explaining the principles behind tests that can be carried out.
- The power up and setup procedure.
- The operating sequences for each of the test modes and the relevant menus.
- The internal setup and results memories and their use.
- The optional memory card facility.
- Producing hard copy of results on an external printer.

Before using the Service Monitor, familiarize yourself with the power requirements and powering up procedure described in Chapter 2, *Installation*.

Front panel layout

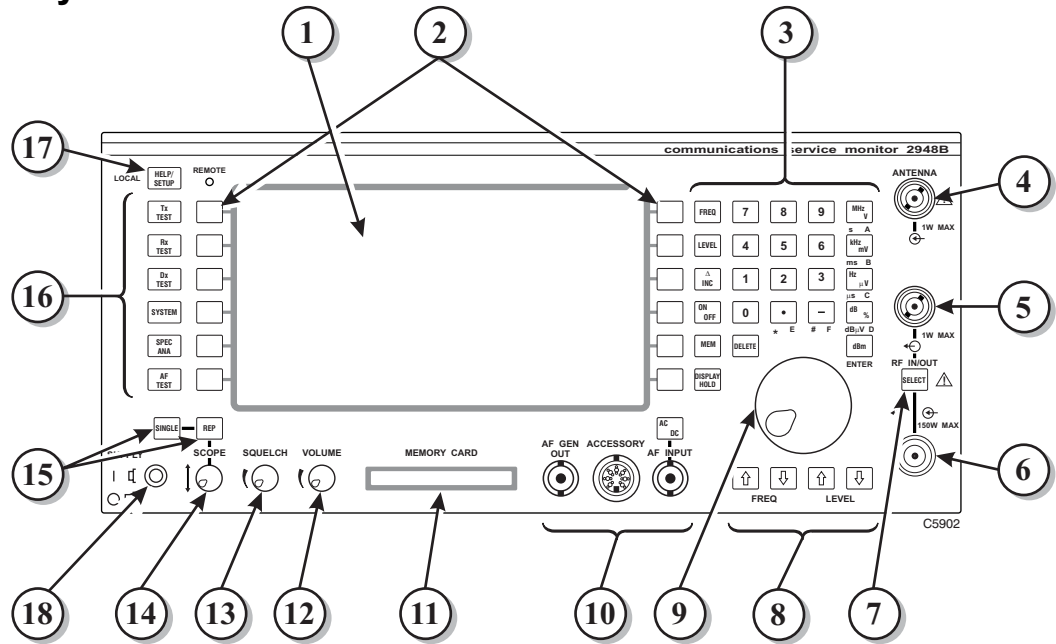

Fig. 3-1 Front panel.

- (1) **Display.** The dominant feature of the front panel is the display screen, used to give information as to the operation of the Service Monitor.

Information relating to the state of the Service Monitor, the mode of operation and results of measurements and tests are all given visually on the display screen. See Fig. 3-2, *Typical displays*.

The screen is divided into four main areas. They are:-

The information display area, which shows the parameters relating to the test, together with settings and results, including bar charts. When the oscilloscope function is called up, all bar charts are removed from the display and the standard or expanded oscilloscope screen displayed.

When the SPEC ANA test mode is selected, the display changes to the SPECTRUM ANALYZER screen.

The test title area, where the current test description is displayed. LED indicators adjacent to each RF connector show the assignment of the connectors. This information is also shown in the test title area of the display when in Dx TEST mode.

Soft key menus, left and right. These areas each have menus of soft key labels designated to the adjacent soft keys. Some modes of operation only require one menu area of six selections. For example, the Tx TEST mode and the AF TEST mode both display and use only the right hand soft keys, the Rx TEST mode only the left hand soft keys. The Dx TEST mode uses the right hand soft keys for transmitter test functions and the left hand soft keys for receiver functions.

LOCAL OPERATION

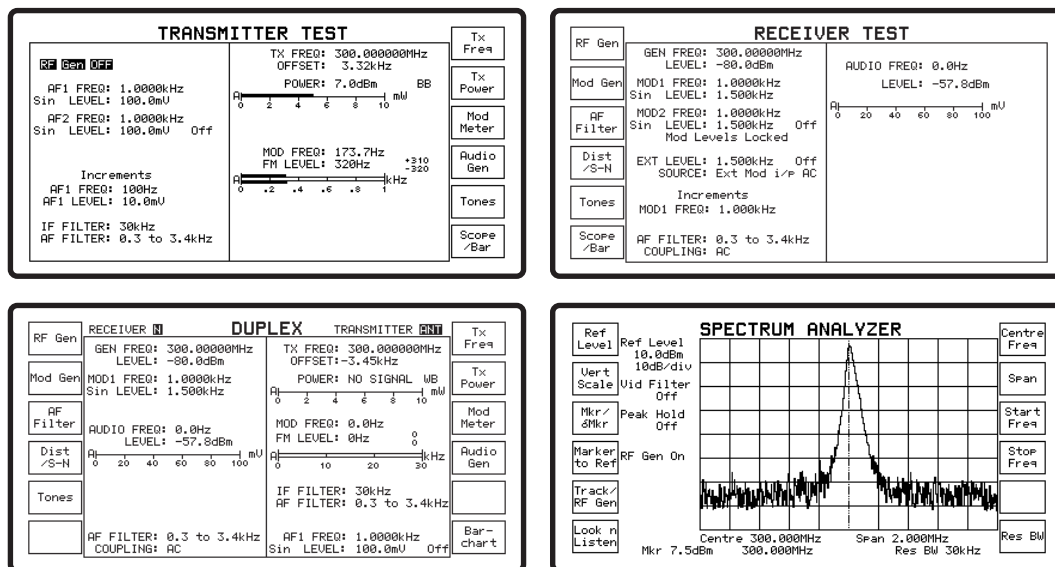

B3271

Fig. 3-2 Typical displays

The various keys on the front panel are grouped according to their use or located adjacent to associated items.

- (2) **Soft keys.** To each side of the display screen are six unmarked keys. These are the 'Soft' keys referred to in the display description above. The specific function of each of these keys is defined by the Service Monitor software and is indicated by the legend on the label immediately adjacent to it on the display screen.
- (3) **Data Input keys.** The right hand area of the front panel contains the 'Data Input' keys. These keys are used to key in data for the various test parameters. They are arranged in three groups:-

Function keys on the left of the group are colored orange. They are used to define the parameter to be addressed; frequency, level, increment change or memory store location; before any digits are entered. The [ON/OFF] function key acts directly on the selected function.

Digit keys are in the center of the group and include the minus sign and decimal point. These two keys have alternative symbols printed beneath them on the front panel which can be entered as data where appropriate. No action other than a normal keypress is required, as only one of the three options for each of these keys is relevant to the entry at any one time. The 'Delete' key back-spaces over figures entered on the display to correct any errors. Corrections cannot be made to an entry after a terminator key has been pressed for that entry. The original setting will be retained if an entry is not completed. The incomplete entry will be replaced on the display by the original setting when a keypress is made that confirms to the program that the setting being made has been aborted.

Terminator keys used to conclude a parameter value are on the right of the group. They are colored orange.

When setting a modulation level, the entry is completed using the Hz, kHz, MHz or % key. The appropriate modulation type, FM or AM, is automatically selected.

(4), (5) & (6) RF input and output connectors.

The three sockets at the right hand edge of the front panel are the RF input/output connectors. Refer to the *Performance data* section in Chapter 1 for measurement accuracy, maximum power input levels and reverse power limits. The nominal impedance of all RF input and output circuits is 50 Ω.

- (4) **ANTENNA connection.** This is a female BNC connector, for 'Off Air' measurements and monitoring, using a suitable antenna. This connector can also be used for direct input of low level signals.
- (5) **BNC RF output connector.** This provides output from the RF signal generator.

- (6) **N type RF connector.** This is dual function, input and/or output. A 20 dB Delta attenuator is incorporated within the Service Monitor. This interconnects the 'N type' connector with the RF generator output and the measuring receiver input, through the input/output selector switching.

WARNING

Hot surfaces

Take care when touching the RF Input N Type connector after the application of high levels of continuous power. If 50 W is exceeded for a prolonged period, the temperature of the connector can become excessive.

- (7) **RF input select key.** The [SELECT] key switches through all the RF connector combinations available. The current selection is indicated by LEDs. The ◐ symbol shows the RF output connector and the ◑ symbol shows the RF input connector.

- (8) **Increment adjustment keys.** Under the variable control are the two pairs of increment adjustment keys, **FREQ** (frequency): [↑] and [↓], and **LEVEL**: [↑] and [↓].

These enable the frequency and level of the RF generator or a selected AF generator to be adjusted in pre-defined steps. The assignment and the value of the steps is shown on the display.

The **FREQ** [↑] and [↓] keys can be assigned to the Tx frequency value or either of the audio generators when in the Tx TEST mode, the RF generator or either of the modulation generators when in the Rx TEST mode, or either of the AF generators when the AF TEST mode is active.

The **LEVEL** [↑] and [↓] keys have the same options. The frequency keys and the level keys do not have to be assigned to the same generator.

The **FREQ** [↑] and [↓] keys can be assigned to the RF generator frequency or transmitter frequency as channel increments.

When operating in Dx TEST mode the increment keys are disabled.

The **SPEC ANA** mode uses the **FREQ** [↑] and [↓] keys for span range and center frequency adjustment. The **LEVEL** [↑] and [↓] keys are used for reference level adjustment. See page 3-69.

The span is ranged up or down in a 1, 2, 5 sequence, from 1.0 kHz to 1.0 GHz.

Adjustment to the span by these keys is linear about the center frequency and will not adjust below zero or above the top frequency limit.

The **LEVEL** [↑] and [↓] keys adjust the reference level range of the spectrum analyzer in either 2 dB or 10 dB steps depending on the setting of the reference level vertical range.

- (9) **Variable control.** The large rotary control under the data input keys is used to make adjustments to frequencies and levels that require a finite change such as when matching a test signal to an undefined signal, or assessing the squelch operating level of a receiver. It has no mechanical stops. This control is also used to select items or digits from displayed lists, in conjunction with **TONES** and **SYSTEM** modes. It is also used for certain finite adjustments to Avionics settings.

- (10) **Audio connections.**

AF GEN OUT socket. The signal available at this BNC socket is the combined output from both or either of the AF generators and/or the tones generator.

AF INPUT socket. Signals fed into this BNC socket can be measured using the AF counter, the AF voltmeter and the distortion measuring circuits. It is also the input for the digital oscilloscope.

ACCESSORY socket. Used for connecting Directional Power Heads and other accessories. The presence of these is automatically detected. The socket is also used for direct connection of a headset, allowing modulation of the signal generator by a microphone and audio signal monitoring through headphones.

When using the accessory microphone with PTT switch, automatic switching between Tx and Rx modes using the PTT switch is possible.

DISPLAY HOLD key. To the left of the variable control is the [DISPLAY HOLD] key. Pressing this key at any time will freeze the display and prevent any adjustment to parameters displayed on the screen. The soft key menu changes to show two keys, *[Store]* and *[Print]*.

The *[Store]* key, gives access to the STORE/RECALL screen and menu. The use of this feature is explained on page 3-91

The *[Print]* key is used to start the Screen Print function. This causes a hard copy of the held screen to be printed onto a suitable printer. If the memory card option is fitted, the current time and date, as held in the Real Time Clock, are printed on the hard copy.

The use of the Screen Print feature is explained under the heading 'Printer' on page 3-100.

AC/DC. AF input coupling option key Located above the AF input socket, this key toggles the AF input circuit between direct and capacitive coupling. The option selected is displayed on the screen.

(11) Memory card slot. Service Monitors with the optional memory card interface fitted can make use of memory cards for the storage and retrieval of results and settings.

Details of the use of memory cards is given under later in this chapter under *Stores, settings and results* on page 3-91 and *Memory Card* on page 3-94.

(12) Volume. This control varies the level of the AF signal fed to the loudspeaker.

(13) RF receiver squelch level control. When monitoring the demodulated output through the loudspeaker or headphones, the RF level below which signals are isolated from the AF circuits can be controlled. Clockwise rotation of the squelch control raises this level and anti-clockwise rotation decreases it.

(14) Scope trace vertical position. This adjusts the vertical position of the trace within the graticule.

(15) Oscilloscope sweep mode keys. The [SINGLE] and [REP] keys, located above the scope vertical position control, select the oscilloscope sweep mode.

(16) Test mode select keys. On the left of the front panel are six blue keys. These are the 'Test Mode Select' keys, used to put the Service Monitor into one of the basic test modes. They are active whenever the Service Monitor is powered up and under local control.

(17) HELP/SETUP key. Above the test mode select keys is the [HELP/SETUP] key.

Pressing this key will cause the HELP/SETUP access screen to be displayed if the Service Monitor is under local control. This does not interrupt any on-going function of the Service Monitor. See *HELP/SETUP* on page 3-10.

When the Service Monitor is under remote control, pressing this key will return control to LOCAL *unless* an instruction to prevent local operation has been sent from the remote control device.

(18) Power on/off switch The push-button power switch connects the power source to the power supply module within the Service Monitor. See the section *Getting started* on page 3-9.

Rear panel controls and connectors

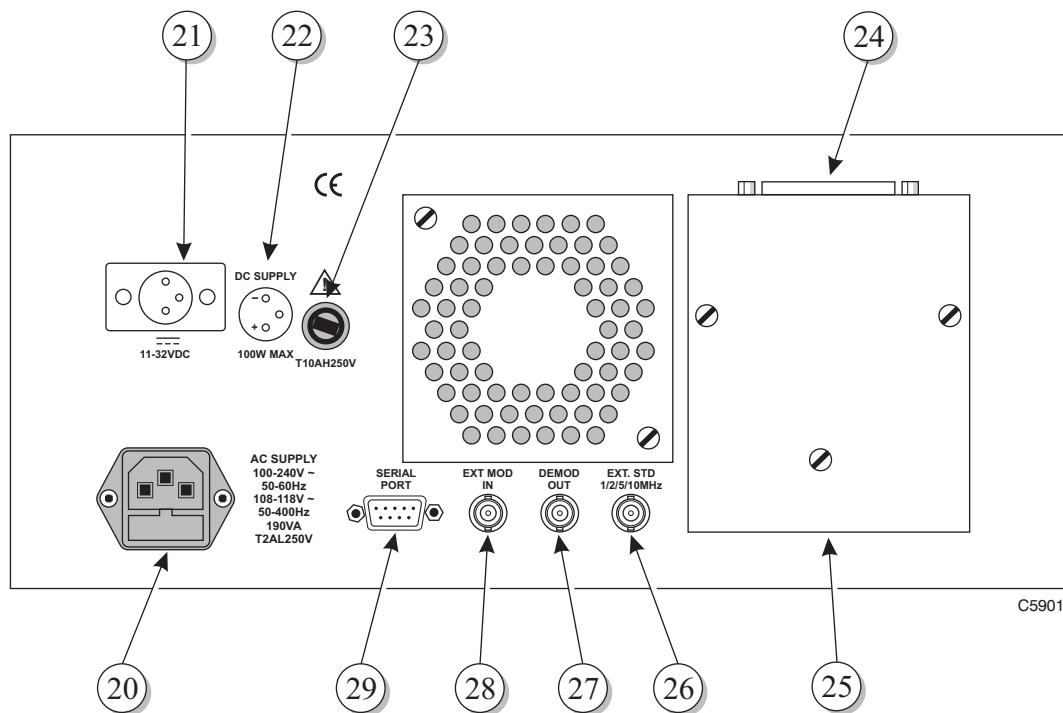

Fig. 3-3 Rear panel layout, (with optional GPIB fitted).

On the rear panel of the Service Monitor are:-

- (20) **AC power supply input connector.** One range for all mains voltages. See the *Performance data* section in Chapter 1. The AC supply fuse is contained within this connector.
- (21) **DC supply input voltage connector.** For powering the Service Monitor from DC supplies. See *Performance data*, in Chapter 1.
- (22) **DC supply pin connection diagram.** Shows the polarity of the DC power connector.
- (23) **DC supply fuse.**
- (24) **GPIB interface connector.** This connector is only present when the GPIB interface option is fitted. Connection details are given in Chapter 2, under *Remote control connections, GPIB*.
- (25) **GPIB interface unit.** Optional. See (24) above.
- (26) **External frequency standard input.** This can be 1, 2.5 or 10 MHz; the Service Monitor will identify the applied frequency. In the event of external standard failure, control will revert to the internal standard.
- (27) **Demodulated signal output.** The demodulated signal removed from the input RF signal is brought to this connector for feeding to external equipment.
or
IF Output. When Option 31 is fitted, the IF Signal is routed to this connector. The demodulated signal output facility is not then available.
- (28) **EXT MOD IN (External modulation input).** A signal applied to this connector can be used as a modulation source for the receiver test signal. The input level of the applied signal should be 1.00 V (RMS sinewave) in order to maintain the correlation with the modulation level calibration. Refer to *Performance data, RF generator*, in Chapter 1 of this manual for frequency ranges.
- (29) **Serial port.** The SERIAL PORT connector provides RS232 interface facilities for remote control. It is also used for the serial output to a printer. Connection details are given in Chapter 2, under *Remote control connections, RS232*.

Getting started

(Applying power and selecting test modes)

The power ON-OFF switch, located on the front of the Service Monitor, will power up the Service Monitor from either an AC or DC supply.

With a power source connected, switching on the Service Monitor will cause the cooling fan to operate and one of the test mode menus to be displayed. Which screen is displayed will depend on which store is selected as the 'Power Up From' store on setup page 2. See *Setup page 2* on page 3-13.

The **BATT** warning is activated when the voltage at the DC terminals falls to approximately 11 volts. If you are unfamiliar with the Service Monitor, a few minutes spent exploring the setup menus and test modes is helpful.

The following explanation of keys and menus will assist in this.

Test mode screens and menus

The six test modes are selected by pressing the appropriate MODE key. These are light blue, with dark blue lettering. (Item 16 in Fig. 3-1, *Front panel*). Select each in turn and observe the display presented.

Each area of six soft key labels forms a menu. Various menus are called up as a result of selecting a change of test mode or by pressing a soft key within a test mode.

Fold out diagrams will be found at the end of this chapter, which show the screens displayed when each of the mode keys is pressed. These also show branching to the second or third level screens and menus. A diagram of the screens accessed from the HELP/SETUP key is also included.

These fold out diagrams are numbered to correlate with the associated key position as follows:-

- (1.0) HELP/SETUP
- (2.0) Tx TEST
- (3.0) Rx TEST
- (4.0) Dx TEST
- (5.0) SYSTEM
- (6.0) SPEC ANA
- (7.0) AF TEST

References in the manual to specific screens on the fold out diagrams is given as in the following example:-

Fold out diagram (2-2-3). This is the screen shown after pressing the [Tx TEST] mode key, then the [*Tx Power*] key (second key down), followed by the [*Harmonic analysis*] key (third key down). Where there are keys on both sides of a screen, keys 1 to 6 are on the left, keys 7 to 12 on the right.

To move to the top level menu of any test mode, including the currently active mode, press the relevant 'MODE' key.

For detailed use of specific TEST MODES see the section later in this chapter relating to that test mode.

HELP/SETUP

Pressing the [HELP/SETUP] key, at any time, will display the screen shown in fold out diagram (1-0), or a variation of it. Displaying the HELP/SETUP screen does not interrupt any ongoing operation or test.

The center panel of the screen lists the following information:-

Serial number of the Service Monitor.
Software fitted, with the version codes and Aeroflex part numbers.
Options fitted to the Service Monitor (except Option 3).

Help

The help facility is accessed by using the [HELP] key. Each soft key in the help menu displays 'On Screen Help' relating to the blue system key to the left of it. The [Return] key removes the on screen help and displays the top level screen of the mode from where HELP/SETUP was selected.

Self Test

Pressing this key gives access to the SELF TEST function of the Service Monitor. Refer to *Self tests and acceptance tests* in Chapter 2, for details.

Diagnostic

The DIAGNOSTIC screen can only be accessed by entering a protection code. When accessed, it allows a low level of software fault diagnosis to be undertaken. Certain areas of memory can also be reset from this screen. Details of access are given in the maintenance manual relating to this instrument.

Calibrate

Access to the CALIBRATION screen is also code-protected. Details relating to access and use are given in the maintenance manual relating to this instrument.

Backlight

This key is the ON / OFF control for the display backlight.

Brightness

Selecting this key allows the illumination level of the display backlight to be varied using the variable control. The illumination level can also be adjusted by the entering a number between 0 and 255 using the data input keys.

Setup

The setup facilities allow selection of options of user preference and system compatibility. There are two setup pages.

Page 1, is accessed by pressing the [Setup] key. It is shown in fold out diagram (1-10), and allows selection of RF generator facilities options.

Page 2, is accessed from Page 1 by pressing the [Setup Page 2] key. It is shown in fold out diagram (1-10-6), and allows selection of AF level measurement units, GPIB address setting, remote control option selection and serial port setup.

The function or options associated with each of the soft keys on the setup pages is described below. The page 2 descriptions start on page 3-13. The keys described below may differ if some options are fitted. See the descriptions relating to those options for details.

Setup page 1

This page allows the following optional settings to be selected.

RF Counter Resolution 0.1 Hz/1 Hz/10 Hz

The RF counter resolution can be set to 0.1 Hz, 1 Hz or 10 Hz. Selecting 1 Hz will slow the screen update rate by a factor of 10:1, selecting 0.1 Hz will slow it by a factor of 100:1. The choice is made by stepping through the three options using the soft key adjacent to the text.

Note

The speed of the autotune function is also related to the selected RF Counter Resolution

RF Level Measured in Watts/Volts/dBm

The RF level from the transmitter being tested can be displayed in terms of Watts into a 50 ohm load, voltage across the 50 ohm load or dBm into 50 ohms. The choice would normally be made so as to match the specification parameter of the transmitter under test. The selection is made by pressing the soft key adjacent to the text. This will toggle through the three options.

AF Distn/SINAD Averages

When distortion or SINAD tests are made to receivers using the Rx TEST mode or AF TEST mode, the results displayed are obtained by averaging the results of a number of measurements. This allows the user to balance the speed of testing against greater repeatability of measurement. The number of measurements made can be set within the range 1 to 20 by entering the required figure using the data input keys.

AF Filters

The AF Low pass and band pass filters available for the Rx TEST mode, for the AF TEST mode and for the modulation meter within the Tx TEST mode can be customized from the setup page accessed from this key.

The AF Filters setup page is shown below.

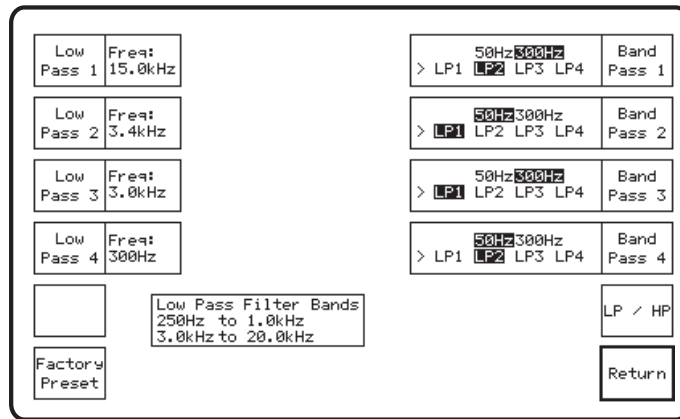

B5888

Fig. 3-4. AF Filter HELP/SETUP page.

Factory Default filter settings

The [Factory Preset] soft key will reset all of the filters to their 'Factory Default' settings. The low pass filter settings are 15.0 kHz (LP1), 3.4 kHz (LP2), 3.0 kHz (LP3) and 300 Hz (LP4).

The 'Factory Default' band pass filter settings are as shown below:-

Band pass 1	300 Hz high pass	3.4 kHz low pass (LP2)
Band pass 2	50 Hz high pass	15.0 kHz low pass (LP1)
Band pass 3	300 Hz high pass	15.0 kHz low pass (LP1)
Band pass 4	50 Hz high pass	3.4 kHz low pass (LP2)

Low pass filters

The four low pass preset filters can each be set to any frequency within the range 250 Hz to 1.0 kHz and 3.0 kHz to 20.0 kHz.

The soft keys associated with the low pass filters are on the left of the setup page.

To set the required frequency, first press the soft key relevant to the low pass filter to be set. The Freq: legend will become highlighted in reverse video. Use the Data Input keys to enter the required frequency and then press the appropriate termination key. (Hz or kHz.)

This frequency will now be assigned to that low pass filter.

Band pass filters

The four band pass filters can each be customized to your requirements by selecting low pass and high pass elements from the as required. The High pass element can be either 50 Hz or 300 Hz, the low pass element can be any of the four preset low pass filters.

To select the required high pass element, first press the *[LP / HP]* soft key once or twice to move the > indicator to the high pass elements on all four soft key settings boxes. Next, press the soft key relevant to the band pass filter to be set. The 50Hz or 300Hz settings will toggle. Repeat this to select the required filter element.

To select the required low pass element, first press the *[LP / HP]* soft key once or twice to move the > indicator to the low pass elements on all four soft key settings boxes.

Next, press the soft key relevant to the band pass filter to be set. Each press will select one of the LP1, LP2, LP3 and LP4 settings in sequence. Repeat until the required low pass filter element is selected.

This setup will now be assigned to that band pass filter irrespective of from what test mode it is accessed.

Atten Hold

The Attenuator Hold facility provides a 'seamless' range of RF Generator output that is not subject to switched attenuator action. The available range is up to 20 dB, with a guaranteed range of 10 dB.

Atten Hold Level

The value entered here sets the upper level of the 'seamless' range of RF Generator output. The value must be within specified output range of the RF Generator. There is no account taken of any RF Power External Attenuator settings entered in the Test Set, neither is the settable range restricted when the 'N' type Connector is selected.

RF Power Ext Atten: dB

The value of any attenuator entered here is considered as part of the instrument and all power measurements will be as from the input to the attenuator, not to the instrument input. Similarly power output levels will be adjusted to take account of the external attenuator value entered.

To enter a value of attenuation, which must be in dB, press the adjacent soft key, key in the digits of the value using the data entry keys and then press the dB terminator key.

The entered value will be applicable to all RF connectors into and out of the monitor. When changing test setups or test modes this must be taken into account to prevent erroneous readings.

The indicator  is shown against any signal level which has been calculated to include the external attenuator.

Rx=Tx Offset Freq: Hz

A setup option within the Tx TEST mode (Rx=Tx) will set the signal generator used for receiver testing to the measured frequency of a transmitter being tested. An Rx=Tx offset frequency entered here will cause the signal generator frequency to differ from the measured transmitter frequency by the offset frequency. To enter an offset frequency, press the adjacent soft key, key in the appropriate digits, using the minus key and the decimal point key if necessary, then use the relevant terminator key, (MHz, kHz or Hz). A positive figure will set the signal generator frequency above the measured transmitter frequency, while a negative figure will set the signal generator to a lower frequency than the transmitter.

RF Level In: EMF/PD

The selection is made by toggle action of the soft key. The PD or EMF flag is shown against output levels displayed as voltage or dB μ V.

With the EMF option selected, the displayed RF output level shows the open circuit voltage available at the RF output connector.

With the PD option selected the displayed RF output level shows the voltage that would be present across a 50 Ω load.

Return

Returns to the Help/Setup Menu.

Setup page 2

This page allows the following optional settings to be selected:-

Audio Level Measured in:

Repeated presses of the adjacent soft key will toggle through Volts, dBm, dBV or Watts and highlight the selection in inverse video.

The level of a signal applied to the AF input socket is measured in terms of the selected option. This will then apply to all subsequent measurements.

The indicated output level from the AF generators is not affected by this selection.

Audio Input Impedance Match:

The impedance selected by this key is used by the Service Monitor to calculate and display the measured voltage as a power (in dBm). Note that the impedance of the AF input remains high. To obtain an accurate measurement the necessary terminating impedance must be added externally.

Audio Input Impedance:

This key is only active if the 600 Ω interface option is fitted. Pressing it will toggle between the 600 Ω balanced input impedance or the standard high impedance. The AF input connector on the front panel is used in either case.

Audio Output Impedance:

This key is also only active if the 600 Ω interface option is fitted. Pressing it will toggle between the 600 Ω balanced output impedance or the standard low impedance. The AF generator output connector on the front panel is used in either case.

20 dB audio attenuator:

This key is also only active if the 600 Ω interface option is fitted. Repeated presses of it will insert or remove a 20 dB attenuator from the output circuit of the audio amplifiers. With the attenuator in circuit the maximum output is limited to 400 mV. The adjustment resolution is increased to 0.01 mV below 40 mV and to 0.1 mV from 40 mV to 400 mV.

Logic Lines

The optional Accessory Port on the rear panel allows the control of external devices by logic control from the instrument. The use of this facility, how to make connections to it and how to set up the switching is explained under *Accessory port (rear optional)* starting on page 3-101

The state of the logic lines are set from the Set-up page accessed by pressing the *[Logic Lines]* soft key.

GPIB Address

Pressing the *[GPIB Addr]* key allows a new GPIB address to be entered by using the data input keys to enter the digits, followed by the ENTER terminator key. It may have a value between 1 and 30.

Remote Control

The Service Monitor can be operated by remote control using either the RS232 (serial) port or the optional GPIB (IEEE 488) interface. The *[Remote Control]* key toggles between the two options. The active function is highlighted in inverse video.

Serial Setup

The *[Serial Setup]* key gives access to the serial port setup menu. The parameters that must be set for compatibility with other equipment connected to the port are:-

Baud Rate; Parity Bit; Character Length; Stop Bit; and Handshaking.

Setting up of the serial port is described in the Chapter 4 of the Programming manual (46882/318) under *Preparing the Service Monitor for remote operation*.

Printer Setup

A menu of printer type options and printer port selection is accessed through this key. The options are:-

Epson FX80 or FX100.

Laser Printer 75 dpi, 100 dpi, 150 dpi.

RS232 serial port or 'Centronics' parallel port. The selected port is highlighted in inverse video. If the parallel port option is not fitted, it is not shown on the menu, and the *[Printer Port]* key enables or disables the RS232 serial port as a printer port.

Power Up From

Successive presses of this key will toggle through the options available for configuration of the Service Monitor at 'Power Up'.

Last Used Store 0

Store 0 is loaded with the current settings each time power is removed from the instrument. With this selection made, the instrument will power up to the same settings as when power was removed, whether this was by user action or through power failure.

Preset Store 1

Store 1 contains the factory preset settings. With this selection made, the instrument will power up to the Rx TEST mode with all settings, for every mode, to the factory preset settings and options.

User Store 2

Store 2 is the first user accessible store, which is loaded through the user memory function. With this selection made, the instrument will power up to the settings stored in user memory store 2 without having to access the memory as a separate function.

Access to the user memory is by pressing the orange [MEM] key. See Stores, settings/results, later in this chapter, starting on page 3-91.

Return

Returns to the last screen displayed prior to the pressing of the Help/Setup mode key.

Card Setup

A section giving a detailed explanation of memory cards and their use will be found later in this chapter starting on page 3-94. This key displays the MEMORY CARD FORMAT screen and menu. The real time clock is also set from this screen.

Return (on the HELP/SETUP screen)

Returns to the last used main mode.

Bar charts

The bar charts used to indicate signal levels can be set to autorange or to user selected ranges. The current state of each bar chart is shown by either an **A** (for Autoranging) or **H** (for Held range) at the left of it. The top level screen of Tx TEST, Rx TEST, Dx TEST and AF TEST, all have a *[Scope/Bar]* key.

Pressing this key will change the soft keys to those shown below. The function of each key is explained.

- [Barchart Select]** This key will select each visible bar chart in turn. The selected bar chart is indicated by a highlighted A or H at the left of it.
- [Auto range]** This key will set the selected bar chart to autorange. If it is currently set to autorange, the key will have no effect.
- [D]** Each press will change the bar chart to the next *highest* range. If the selected bar chart is set to autorange, the first press will remove autoranging and hold the current range. The next press will change the range. When the highest range is set, subsequent presses will have no effect.
- [C]** Each press will change the bar chart to the next *lowest* range. If the selected bar chart is set to autorange, the first press will remove autoranging and hold the current range. The next press will change the range. When the lowest range is set, subsequent presses will have no effect.
- [Scope/Bar]** Pressing this key once, will remove the bar charts from the display and cause the normal oscilloscope to be displayed. Subsequent presses will display the expanded oscilloscope, then the bar charts again.
- [Return]** This key will display the top level screen of the selected test mode.

Spectrum analyzer

The spectrum analyzer (SPEC ANA) mode presents a graphical display of Radio Frequency against RF level over a selected sweep of the RF spectrum.

Data relating to the setup and to measurements of the signals being analyzed is presented on the periphery of the display.

As well as the basic spectrum analyzer function, the monitor has a ‘Look and Listen’ function which allows the operator to listen to the demodulated signal extracted from the RF signal being examined.

Oscilloscope

The digital oscilloscope function, available from the Tx, Rx and AF test modes, displays signal waveforms on part of the display screen. The operation of the oscilloscope function is described in detail later in this chapter under *Oscilloscope*, starting on page 3-89.

When reference to the oscilloscope facility is necessary when describing other functions, this is indicated by heading the reference, ***OSCILLOSCOPE***, ***STANDARD OSCILLOSCOPE*** or ***EXPANDED OSCILLOSCOPE*** as appropriate.

Using the test modes

Brief descriptions

As the Service Monitor 2948 is a duplex instrument, the RF signal generator and the receiver circuits are able to operate simultaneously. This allows mobile transceivers to be tested under their normal operating conditions, with both their receiver section and transmitter section functioning. By selecting a particular test mode on the Service Monitor, one or both sections of the transceiver can be studied. A brief description of the function of each test mode is given below. Detailed user instructions follow under the relevant headings.

Tx TEST

With Tx TEST selected, the **TRANSMITTER TEST** screen is displayed and access to all Tx TEST mode features is available. See fold out diagram (2-0) at the end of this chapter.

The AF voltmeter makes measurements to the signals from the Service Monitor demodulator and displays the results.

The RF signal generator is active, producing an RF signal at the frequency and level set in the Rx TEST mode. This signal will be modulated at the level and frequency set, if the modulation generator selection does not conflict with the requirements of the Rx TEST mode.

Rx TEST

With Rx TEST mode selected, the **RECEIVER TEST** screen is displayed and access to all Rx TEST mode features is available. See fold out diagram (3-0) at the end of this chapter.

The AF voltmeter makes measurements to the signal obtained from the demodulated output of the mobile transceiver and fed into the AF INPUT socket on the front panel of the Service Monitor. The AF generators are active at the frequencies and levels set in the Tx TEST mode and their output routed to the AF GEN OUT socket on the front panel of the Service Monitor. The AF generator selection can conflict with the requirements of the Tx TEST mode.

Dx TEST

With Dx TEST selected, the **DUPLEX TEST** screen is displayed and access to transmitter and receiver test features is available. See fold out diagram (4-0) at the end of this chapter. These features are not as comprehensive as those available from the **TRANSMITTER TEST** or **RECEIVER TEST** screens, but do allow measurements to be made to the major parameters. The Service Monitor has two AF generators, either or both of which can be used to modulate the transmitter being tested or the RF generator. However, each generator can only serve one function at the same time. There is only one AF measurement path, which is switched by the software between receiver test and transmitter test functions.

SPEC ANA

With SPEC ANA selected, the SPECTRUM ANALYZER screen is displayed and access to the spectrum analyzer features is available. See fold out diagram (6-0) at the end of this chapter. The RF signal generator is active, producing an RF signal at the frequency and level set in the Rx TEST mode, if the tracking generator feature is not selected. The spectrum analyzer tracking generator signal is provided by the RF generator.

The modulation generators will modulate the RF signal generator, with the same provisos as in Rx TEST mode. If the **LOOK AND LISTEN** screen is displayed, AF Gen 2 is used to provide the sweep signal, therefore it is not available to provide modulation.

AF TEST

With AF TEST selected, the **AUDIO TEST** screen is displayed and access to the AF TEST features is available. See fold out diagram (7-0) at the end of this chapter. The RF generator is disabled.

SYSTEMS

The SYSTEM key gives access to the SYSTEM TEST mode. If any of the system test options have been provided on the particular Service Monitor, the user is able to carry out automatic and/or manual tests to pertinent equipment. The use of the SYSTEM TEST mode is described in the supplementary operating manuals, supplied when any of these options are fitted. Fold out diagram (5-0) at the end of this chapter shows typical SYSTEM TEST mode displays. The displays from all keys are not shown, as there are many similarities to the various systems.

Press To Talk facility

A mode switching capability is provided by the 'Microphone with PTT switch' optional accessory. See *Performance data, optional accessories*, in Chapter 1.

With 'microphone' selected as the external modulation source and the Service Monitor operating in the Tx TEST mode, pressing the PTT switch will cause the Service Monitor to switch to the Rx TEST mode.

With the Service Monitor set to the Rx TEST mode or Dx TEST mode, pressing the PTT switch will allow voice modulation of the RF signal from the Service Monitor, but mode switching will not happen.

Tones

A soft key designated [*Tones*] is included in the top level menus of the Tx TEST mode, Rx TEST mode, Dx TEST mode, and AF TEST mode.

Pressing this key will display the menu shown in fold out diagram (2-5), (3-5), (4-5) or (7-5), and give access to the 'TONES' test facility. This facility is used to provide modulation generators and demodulation decoders to simulate the various coded calling signals used on mobile radio systems for automatic selective calling of mobile transceivers.

General

The instructions for transmitter testing assumes that the Tx TEST mode has been selected, and for receiver testing assumes that the Rx TEST mode has been selected. However, these instructions apply equally to the Dx TEST mode. References are made to Dx TEST mode to clarify this, or to identify a difference in presentation. These references are headed *DUPLEX*.

The Dx TEST mode, the Oscilloscope function, and the TONES facility, each have a section of this chapter dedicated to their operation.

Tx test (transmitter testing)

Overview

The Communications Service Monitor 2948 has been designed to test the performance of mobile communication equipment. This section explains the use of the Tx TEST mode. Typical uses are:-

- Performance checking following manufacture
- Routine quality assurance testing
- Workshop or field fault diagnosis etc.

The operation of the Avionics SYSTEM function is explained in Appendix B, *Avionics System*.

The tests which need to be carried out will depend on the specification of the transmitter and the reason for testing, however a generalized list would be:-

Transmitter power Transmitter frequency RF distortion Spurious outputs Modulation characteristics Modulation frequency response Companding/limiting Modulation distortion
--

This Service Monitor will perform all of the above tests.

With the Tx TEST mode selected, the screen and menu shown in fold out diagram (2-0) is displayed.

Using this screen and menu, the Service Monitor is set up for transmitter testing, and the test results displayed.

The sections of the monitor available for transmitter testing are:-

The AF generators, used to provide a modulating signal for the transmitter.

The audio tones generator. Used to provide sequential tones for POCSAG and DCS systems.

The RF power meter.

The RF counter.

The modulation meter, to measure the depth of amplitude modulation or the deviation of frequency modulation and to recover the modulating signal for other tests. The demodulated output is fed to the audio amplifier, and can therefore be monitored on the loudspeaker or on a headset connected to the accessory socket. The SSB option allows Single Side Band modulation to be demodulated.

The oscilloscope, to examine the wave form of the demodulated signal.

As well as setting up the major sections of the Service Monitor, the following parameters are selected from the TRANSMITTER TEST screen:-

The TRANSMITTER TEST screen allows setting of the following;

IF filter bandwidth.

AF filter pass-band.

De-emphasis filtering.

Distortion measurement methods.

Connections

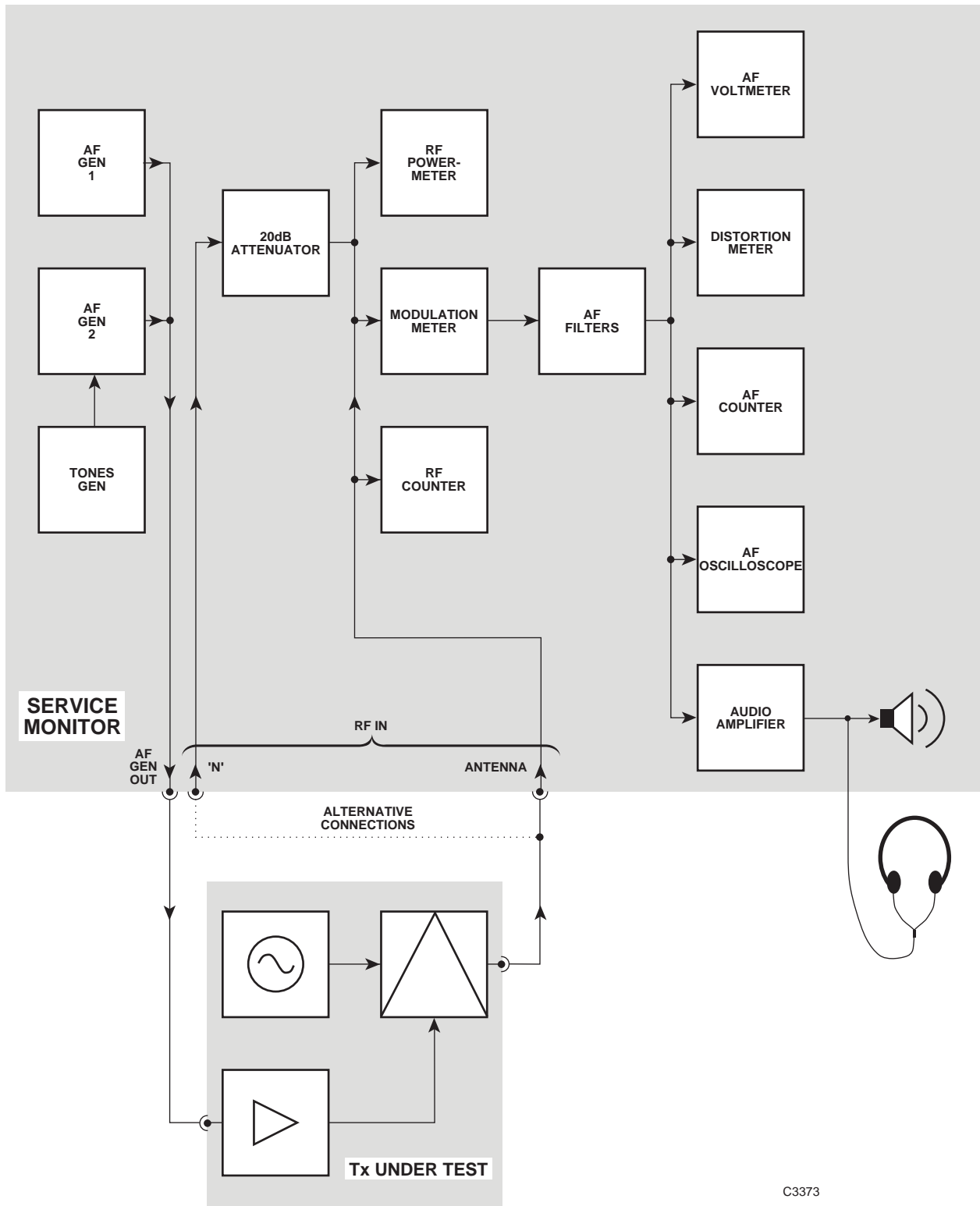

C3373

Fig. 3-5 Transmitter test connections

The transmitter and the Service Monitor are connected as shown in Fig. 3-5, *Transmitter test connections*. The block diagram of the Service Monitor shows the signal routing within it.

The Audio frequency input connection to the transmitter must be to the audio input, in place of the usual microphone input. This connection will vary for differing types of equipment. Points to note are:-

- The microphone must be disconnected, as any input from it would affect the performance of the test.
- The microphone and its cable may complete the 'keying' circuit of the transmitter using a 'press to talk' switch, in which case an alternative arrangement must be provided.
- The RF output connection from the transmitter should be made using good quality RF cable with correctly fitted connectors. Worn connectors and damaged or kinked cable can give rise to high levels of reflected power. This can cause misleading results and possible damage to the transmitter.
- Consider the power output of the transmitter and connect to the appropriate input connector on the monitor. The maximum power to the BNC (Antenna) socket is 1 W and to the 'N-Type' connector 150 W. If the transmitter output power exceeds this level then a suitable power attenuator should be connected between the transmitter and the monitor or a calibrated 'sniffer' used to take a sample of the output, using a dummy load if necessary.
- The power source for the transmitter should be reliable and stable. The battery of a vehicle may discharge if supplying a transmitter during prolonged testing or the 'earth' common return connection may become open circuit if the transmitter is removed from its normal location.

The procedure for making each of the tests listed above follows. Some of the tests may require separate operations and others will only require a reading to be made.

WARNING

Hot surfaces

Take care when touching the RF Input Type N connector after the application of high levels of continuous power. If 50 W is exceeded for a prolonged period, the temperature of the connector can become excessive.

Setting up

When all the required connections have been made, select the Tx TEST mode to display the screen and menu show in fold out diagram (2-0).

Set the parameters or options to suit the test requirements, from the TRANSMITTER TEST menus.

The complete setup can be stored by making use of the internal setup/results memories or the optional memory card facility. Both of these features are described under *Stores, settings/results*, later in this chapter, starting on page 3-91.

RF generator state

This Service Monitor is a duplex instrument as mentioned earlier. (See *Using the test modes*, on page 3-16.) The state of the RF generator is shown on the TX TEST display by the legend **RF GEN ON** or **RF GEN OFF**. The state of the RF generator can be switched by pressing the top left soft key.

Tx frequency

Press the *[Tx Freq]* key.

The soft key options change to those shown in fold out diagram (2-1).

The receiver circuits of the Service Monitor must be set to the RF output frequency of the transmitter under test. This can be set manually using the data input keys, or automatically by pressing the *[Auto Tune]* key.

Manual frequency setting

Range; 100 kHz to 1.05 GHz

With the **TX** **FREQ** legend highlighted, data can be entered from the keyboard to the Tx FREQ parameter. As the entry can only be a frequency setting, it is not necessary to select the orange [FREQ] key. Enter the required frequency by using the digit keys and the decimal point key if relevant. The resolution of the RF FREQ entry is 1 Hz, but it is not necessary to enter every digit down to the least significant place if a ‘multiplier’ terminator key is used.

The entry is completed by pressing a terminator key. Using the [MHz], [kHz] or [Hz] key causes the entered frequency to be displayed according to normal convention. The following examples explain further.

Pressing:-

[1] [2] [5] [MHz]	will display	125.000000 MHz
[1] [2] [5] [kHz]	" "	125.000 kHz
[1] [2] [5] [0] [kHz]	" "	1.250000 MHz
[1] [.] [2] [5] [MHz]	" "	1.250000 MHz
[1] [2] [5] [0] [0] [0] [1] [Hz]	" "	1.250001 MHz

Variable control

With the **TX** **FREQ** legend highlighted, the Tx FREQ parameter can be adjusted by using the variable control.

Frequency increment

The FREQ [\uparrow] and [\downarrow] keys can be assigned to transmitter frequency adjustment. Refer to the section on incremental adjustments which starts on page 3-68.

Automatic frequency setting

Pressing the *[Auto Tune]* key causes the Service Monitor to sweep over the RF input range and lock onto the strongest signal present on the selected RF input socket. The mean frequency of the signal is displayed against the Tx FREQ legend, with Auto tune replacing OFFSET.

Note

SSB (if fitted). The autotune function may not operate when attempting to tune to an SSB transmitter unless a steady tone is being used as a modulation source. The frequency to which the Service Monitor will tune will be the true RF frequency of the sideband and not that of the channel frequency.

Pressing the *[Rx=Tx]* key causes the RF generator used for the Rx TEST mode to be set to the same frequency as the measured RF from the transmitter under test. A frequency offset facility can be set up which gives a set difference between the frequency of the measured transmitter RF and the set frequency of the receiver test generator. ($Rx=Tx \pm \text{offset}$). See the option selections within setup page 1, for more information.

Pressing the *[Offset in ppm]* key causes the Frequency Offset readout (error from the set frequency) to be displayed as parts per million of the set Tx frequency.

After setting the Tx FREQ and any associated adjustments, use the *[Return]* key to revert to the original TX TEST menu.

Tx power

The *[Tx Power]* key gives access to RF power measurement functions or associated functions.

Broad Band or Narrow Band power

The *[Broad/Narrow]* key selects which of the RF power measurement methods is operative. The selected method is indicated on the display by the letters BB or NB to the right of the digital power reading. The use of this facility is explained under *Making measurements* later in this chapter. See page 3-27.

Directional Power

The *[Dir Power]* key displays the screen required for using the optional directional power and VSWR accessories. The use of the Directional Power Head accessory is described in Appendix A of this manual.

To leave this screen, press any of the blue MODE keys. The top level screen of that mode will be displayed.

RF harmonic Analysis

The *[Harmonic Analys]* key activates the RF harmonic Analysis function. The right-hand side of the screen shows five horizontal bar charts. The upper bar chart shows the power meter reading and is the same as that shown on the other Tx TEST screens.

The four HARMONICS bar charts, display the level of the 2nd, 3rd, 4th and 5th harmonics of the carrier. The frequency range of the Service Monitor governs the number of harmonics of which readings can be made.

The use of this facility is explained under *Making measurements* later in this chapter. See page 3-28.

Pressing the *[Return]* key will display the previously used Tx TEST screen with the Tx power menu.

RF transient power Analysis

The *[Trans Analys]* key selects the RF Power TRANSIENT ANALYSIS mode.

This mode displays a captured RF power profile of a transmitter against time. Triggering is activated by the RF level passing a preset value. The signal is captured using a continually updated, first in/first out, storage device. This allows the Service Monitor to show the power profile both before and after the trigger point.

The use of this facility is explained under *Making measurements* later in this chapter. See page 3-29

Pressing the *[Return]* key will display the previously used Tx TEST screen with the top level Tx TEST menu.

Occupied Bandwidth

The *[Occ B/width]* key is displayed if the option is enabled. It selects the RF Power OCCUPIED BANDWIDTH mode.

This mode provides a Spectrum Analyzer display of RF level against frequency, with markers to indicate the extent of the bandwidth occupancy of the displayed signal, for the selected Occupied Bandwidth Ratio.

The Occupied Bandwidth Ratio is variable in 0.1% steps within the range 90.0 to 99.9%.

The display has soft keys to allow selection of Display RF Reference Level, Occupied Bandwidth Ratio, Test Set RF Generator ON/OFF, Display Center Frequency, Display Span and Display Resolution Bandwidth.

The use of this facility is explained under *Making measurements* later in this chapter. See page 3-33.

Modulation meter, demodulation options setup

Set up the demodulation options to be compatible with the transmission from the unit under test.

Press the *[Mod Meter]* key. The soft keys change to the demod soft keys shown in fold out diagram (2-3).

Modulation Type

The Service Monitor can demodulate AM and FM signals. The demodulated signal is made available at the 'DEMOD OUT' connector on the rear of the Service Monitor. SSB signals can be demodulated if the SSB option is fitted.

The *[AM/FM]* key, or *[AM/FM/SSB]* key, is used to select the appropriate modulation type by sequential key presses. The MOD LEVEL indication within the main display becomes suffixed by % for AM; and by MHz or kHz for FM. When SSB has been selected, no modulation level is shown, either digitally or as a bar chart.

Selecting the modulation type for Tx TEST does not change the current modulation type set on the Service Monitor RF generator.

SSB Input sensitivity

No RF carrier signal is produced by SSB transmitters. Therefore the automatic gain control circuits of the Service Monitor cannot respond to these signals.

When 'SSB' demodulation has been selected, the RF sensitivity of the Service Monitor can be controlled manually. Three sensitivity settings are given as soft key choices; high, medium and low. The approximate sensitivities of these are shown in the following table:-

<i>[High Sens]</i>	-90 dBm to -30 dBm at 'N type'. -110 dBm to -50 dBm at 'Antenna'
<i>[Med Sens]</i>	-30 dBm to +20 dBm at 'N Type' -50 dBm to 0 dBm at 'Antenna'
<i>[Low Sens]</i>	+20 dBm to +50 dBm at 'N Type' 0 dBm to +30 dBm at 'Antenna'

WARNING

Hot surfaces

Take care when touching the RF Input Type N connector after the application of high levels of continuous power. If 50 W is applied for a prolonged period, the temperature of the connector can become excessive.

IF bandwidth

The IF bandwidth of the Service Monitor receiver circuits can be selected from the following options:-

300 Hz	3.0 kHz	30 kHz	300 kHz
--------	---------	--------	---------

Press the *[IF Filter]* key. The right hand soft keys change, to allow selection of IF bandwidth filters as shown above.

The selected filter is shown on the display. Press the *[Return]* key after selecting the required filter.

Audio frequency filtering

The demodulated signal can be filtered using high pass, low pass or band pass audio filters and with weighting filters as required.

Press the *[AF Filter]* key. The right hand soft keys change, to allow selection of AF filters as shown below. Press the *[Return]* key after selecting the required filter.

High Pass	Low Pass	Band Pass	CCITT [†] or C-MESS [‡]	Deemph
-----------	----------	-----------	---	--------

[†] Only if option 23 (CCITT filter) is fitted.

[‡] Only if option 24 (C-MESS filter) is fitted.

The high pass filter options are 50 Hz or 300 Hz.

There are five low pass filter soft keys. The 50 kHz LP filter can be considered to be the 'unfiltered' selection as this represents the normal full bandwidth of the audio circuits.

The other four low pass preset filters can each be set to any cut-off frequency within the range 250 Hz to 1.0 kHz and 3.0 kHz to 20.0 kHz.

The band pass preset filters can be customized by selecting either of the high pass options in combination with any of the four preset low pass filters.

The preset filters are set from the HELP/SETUP facility. The AF Filter setup explanation starts on page 3-10.

De-emph

De-emphasis filtering, ON/OFF, is toggled by alternate presses of the *[Deemph]* key. The de-emphasis filtering uses a 750 µs time constant to give a 6 dB/octave roll-off.

De-emph ON appears on the main display when appropriate. No indication is given to show that de-emphasis is not on.

Press *[More]* to return to the previous menu or *[Return]* to display the main Tx TEST menu.

OSCILLOSCOPE

The input to the oscilloscope is taken from the demodulators through any selected AF filters. Therefore modulation measurements made using the oscilloscope will include the characteristics of the selected AF filter.

Audio distortion measurement

The Service Monitor is able to measure signal noise and distortion against the following parameters:-

Signal to noise ratio	SINAD level	Percentage distortion.
-----------------------	-------------	------------------------

Press the *[Dist S/N]* key. The right hand soft keys change, to allow selection of S/N, SINAD and distortion measurements.

Off

Disables any active distortion measuring function.

Hint. By disabling this function, the time taken to measure the remainder of the measurement functions is shortened thereby reducing the update time.

S/N

Selects signal to noise ratio as the measurement method. The Signal to Noise bar chart ranges available are 0 to 30 dB and 0 to 100 dB. The signal to noise ratio is displayed as a digital read-out above the bar chart. The TX TEST mode menu is recalled automatically after pressing this key.

SINAD

Selects SINAD as the measurement method.

The AF1 generator will be set to 1 kHz by this action, regardless of any previous setting.

The distortion bar chart ranges available are 0 to 18 dB and 0 to 50 dB. The SINAD level is displayed as a digital readout above the bar chart. The TX TEST mode menu is recalled automatically after pressing this key.

Dist'n

Selects distortion percentage as the measurement method.

The AF1 generator will be set to 1 kHz by this action, regardless of any previous setting.

The distortion bar chart ranges available are 0 to 10%, 0 to 30% and 0 to 100%. The distortion percentage level is displayed as a digital readout above the bar chart. The TX TEST mode menu is recalled automatically after pressing this key.

With all the required parameters set, power up the transmitter.

The power output of the transmitter is shown on the POWER LEVEL bar chart, with the power level given in digital form above it.

The level of modulation is displayed on the modulation level bar chart, with the FM DEVN or the AM DEPTH shown digitally. When the SSB demodulation function has been selected, no modulation bar chart is displayed. The legend 'SSB Trans' and the selected sensitivity is shown.

The FREQ OFFSET will indicate the difference between the mean (measured) frequency of the transmission and that entered as transmitter frequency.

More (FM deviation pk/rms, Inst dBr, dBr Ref, Abs Meas

Press the *[More]* key. The right hand soft keys change, to allow selection of the FM deviation and AM modulation measurement modes.

Press *[More]* to return to the previous menu or *[Return]* to display the main Tx TEST menu.

FM Dev Pk/rms

Toggles between measuring FM modulation with the RMS detector or with the peak detectors. The measurement mode – Pk or rms – appears to the left of the FM deviation bar chart.

Inst dBr

Pressing the *[Inst dBr]* soft key captures the current modulation level reading and enters it as the dBr reference level.

dBr Ref

Pressing the *[dBr Ref]* soft key allows a modulation reference level to be set, so that the digital modulation reading is shown as dBr levels relative to the reference. The bargraph readout and the positive and negative readings continue to display the absolute values.

The reference level can be set using the Data input keys or captured from the current absolute measurement by pressing the *[Inst dBr]* soft key.

Abs Meas

Pressing the *[Abs Meas]* soft key cancels the current dBr reference level and restores the digital modulation reading to absolute levels.

Audio generator setup

Freq. range	10 Hz to 20 kHz
Level range	0.1 mV to 4 V RMS
Shape option	Sine or square

To set up the audio generators in order to modulate the transmitter, press the [Audio Gen] key. This will display the audio setup menu shown in fold out diagram (2-4).

Set up the audio generator(s) for the required frequency and output level by using the soft keys and data input keys:-

[Gen 1/Gen 2] to select AF1, then, [FREQ][n]...[n][kHz/Hz]

[LEVEL][n]...[n][V/mV/dBm]

then [Gen 1/Gen 2] to select AF2 if required, ...[.../dBm]

The FREQ [↑] and [↓] and the LEVEL [↑] and [↓] keys can be assigned to AF generator frequency and level. See Incremental adjustments which starts on page 3-68.

Either or both generators can be switched off to suit the test requirement. To disable a generator select it using the [Gen 1/Gen 2] key to toggle between them. When the title of the generator is highlighted on the display, press the orange[ON/OFF] function key. Repeated presses of this key will toggle the ON/OFF action.

The shape of each audio generator output waveform can be either sine or square wave. This is controlled by first selecting the audio generator as for [ON/OFF] control above, then pressing the [Shape] key to toggle between the options.

Note that the audio generators are also used as modulation generators for the receiver test signal generator. If both generators are set up as a modulation source in the Tx test mode, switching to Rx TEST mode will show both modulation generators in the OFF condition. Either or both generators can be set up and turned on within the Rx TEST mode.

The frequency, level and shape settings of their last use in the Rx TEST mode will be retained within the Rx TEST mode setup. These settings will be effective when the generators are switched to the 'ON' condition in receiver test mode. Their use as audio generators in the Tx TEST mode will then be disabled.

Pressing the [Lock] key locks the output level of the two audio generators to the same level. The unselected generator locks to the level of the selected generator.

When the audio generators are set to the required settings press the [Return] key to restore the Tx TEST menu.

Making measurements

This section describes the actions needed to make measurements of each parameter associated with transmitter testing. All tests are described individually as 'one off' tests, but in practice, once set up, all active parameters will be measured simultaneously with continuous updating and the results displayed using the selected measurement units.

The results obtained from tests can be stored for later analysis or transfer to hard copy by making use of the internal setup/results memories or the optional memory card facility. Test mode screen settings can similarly be stored for future use. All of these features are described under *Stores*, *Settings/results*, or *Printer*, later in the chapter.

Transmitter power

Broad Band and Narrow Band power measurements

The monitor has both Broad Band and Narrow Band power measurement facilities. The Broad Band power meter measures the total average power of all signals present at either RF input, while the Narrow Band power meter measures only the average power of the signal contained within the IF pass band selected for the Tx TEST mode.

The facilities of the Service Monitor allow the RF signal generator to remain active in the Tx TEST mode. Therefore the signal from this will be present at common points within the RF input/output circuits of the Service Monitor and will contribute to measurements made by the power meters. When making measurements where this will make any significant difference to the measurement, disable the RF generator by selecting the RF Gen OFF condition from the Rx TEST mode or the Dx TEST mode.

Narrow band power measurements cannot be made when the frequency of a transmitter has been set using the *[Auto Tune]* key.

The maximum continuous power rating of the 'N-Type' connector is 50 W with a minimum indication of 5 mW. Lower levels of input signal are indicated as voltage levels, the first bar chart graduation being at 20 μ V. The maximum continuous power rating of the antenna BNC connector is 5 W.

CAUTION

A power overload condition is indicated by an audible and visual warning. Should this condition be indicated, immediately reduce the level of RF power from the transmitter into the Service Monitor.

Do not stop the warning by switching off the Service Monitor, as this will silence the warning but will leave the excessive RF power connected to the internal load.

Do not attempt to stop the warning by disconnecting the RF connector, as this can damage the transmitter and may cause electric shock or skin burns

WARNING

Hot surfaces

Take care when touching the RF Input Type N connector after the application of high levels of continuous power. If 50 W is applied for a prolonged period, the temperature of the connector can become excessive.

With the monitor in the Tx TEST mode, and the transmitter connected to the monitor as described above, key up the transmitter.

The RF power bar chart gives an analogue representation of the active power meter reading. A digital read-out of the power is displayed above the bar chart.

The options available for the digital read-out from the power meter are dBm, Watts or Volts.

The bar chart can be auto-ranging or manually selected. See Bar charts on page 3-15.

External attenuators can be included in the input path to the Service Monitor. The value of any such attenuators can be entered into Setup Page 1 of the Service Monitor, which will cause the power measurement software to calculate the power at the attenuator input. The result of this calculation is shown on the RF power bar chart and as the digital power reading.

Power readings which include an attenuation factor have an inverse video 'A' adjacent to them.

The full-scale ranges of the RF power bar chart, are:-

- 10 mW to 100 kW in 15 steps of 1-3-10 sequence.
- 100 mV to 3 kV in 16 steps of 1-3-10 sequence.

Directional power measurements

Directional power and VSWR measurements can be made using the optional Directional Power Head accessory. The DIRECTIONAL POWER METER screen, accessed by pressing the [Dir Power] key, is used with these accessories. To leave the DIRECTIONAL POWER METER display and return to the Tx test mode display, press the [Tx TEST] key. See Appendix A.

RF harmonic analysis

The harmonic content of a transmitter output can be analyzed using the harmonic analyzer function.

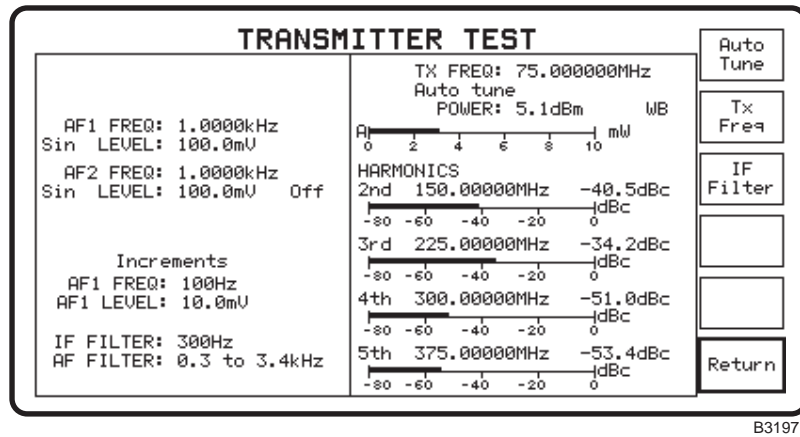

Fig. 3-6 Tx power, harmonic analysis screen

To obtain an analysis of a signal, proceed as for making a power level reading. With the power level of the signal to be analyzed displayed, press the [Harmonic Analys] key. The screen shown in Fig. 3-6, Tx power, harmonic analysis screen, is displayed. The power level bar chart shows the power output of the transmitter as before. The harmonic content of the signal is shown on the HARMONICS bar charts. These four bar charts are each given to progressive harmonics of the fundamental frequency of the signal. They are graduated in dB relative to the carrier level (dBc), from 0 to -80 dBc.

The harmonic number and frequency is shown over each active bar chart, with the level, in dBc, given as a digital read-out.

The level of a harmonic which has a frequency above the RF range of the monitor cannot be measured and bar charts which would be given to these frequencies remain inactive.

IF passband filters

When making harmonic analysis readings, the IF passband of the Service Monitor can be set independently to that set in the main Tx TEST mode. Pressing the [IF Filter] key when the harmonic analysis function is displayed, allows selection of the following IF passband filters.

300 Hz	3 kHz	30 kHz	300 kHz
--------	-------	--------	---------

The filter selection is retained within the harmonic analysis setup. The IF filter selected in the main Tx TEST mode will be unchanged.

For accurate results, the noise floor over the measurement range should be as low as possible, but the passband should not clip the sidebands of the fundamental signal. Select the filter that will best suit these requirements.

As the Spectrum Analyzer uses the same IF filters, the optimum filtering can be selected by examining the signal using the Spectrum Analyzer.

Pressing the *[Return]* key will display the top level Tx TEST mode screen.

If the operating mode of the Service Monitor is changed from Tx TEST mode with the harmonic analysis function selected, the harmonic analysis screen will be displayed again when Tx TEST mode is next selected.

RF transient power analysis

This facility is used to capture, display and record changes to power levels of RF signals. The TRANSIENT ANALYSIS screen, used to control and display this function, is accessed from the Tx TEST mode by the key sequence *[Tx Power]*, *[Trans Analys]*. See Fig. 3-7, *Power Transient Analysis screen*.

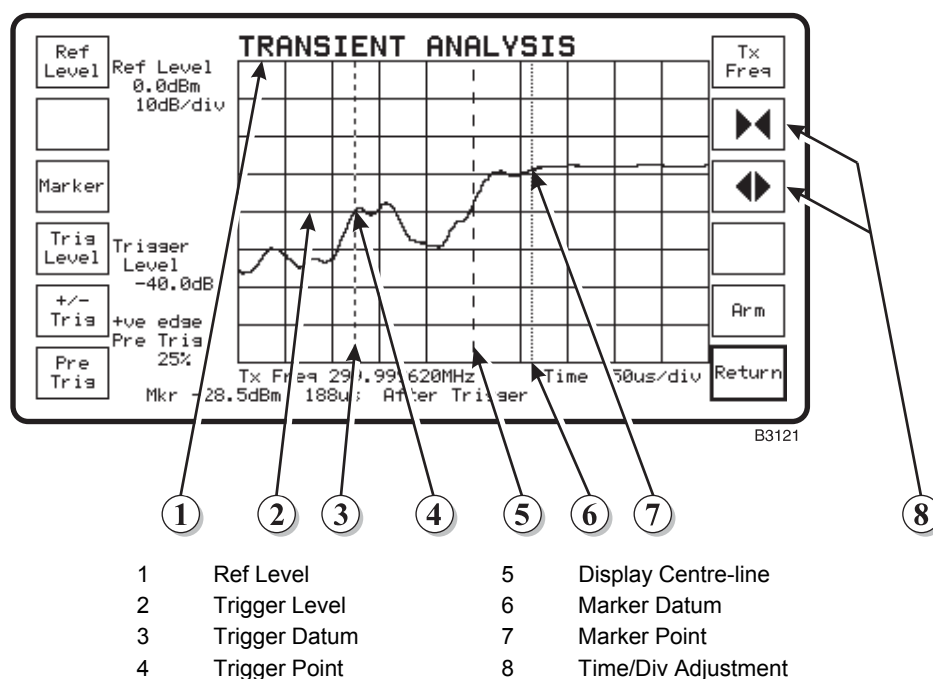

Fig. 3-7 Power Transient Analysis screen

To observe the power level profile of an RF signal during a level transition, the signal is applied to the RF input of the monitor and the Service Monitor armed to trigger when a specific RF level is passed through.

The Service Monitor then displays an RF Power Level vs Time graph, showing the transition.

Bandwidth

The IF filter selected on the Tx TEST screen remains selected when the TRANSIENT ANALYSIS function is selected.

Ref level

The graticule of the transient analysis screen is calibrated in 10 dB/division vertically with the top of the display as the reference level.

To set the reference level, press the *[Ref Level]* key to highlight the Ref Level legend. The required reference level can then be set, either by entering a new value using the data entry keys, or by adjusting the variable control. The reference level should be set so that the expected maximum and minimum levels will be visible on the display.

Note

The reference level setting is common with the SPEC ANA mode reference level; a value set on one, will be found set on the other, when next accessed.

Marker

A variable marker can be displayed, indicated by a fine dotted vertical line, with a read-out of the marker values displayed at the bottom of the screen. The marker reading provides two values:

The absolute RF power level at the marker position (not the level relative to the Ref Level).

A time difference of the position of the marker relative to the trigger point.

If the marker, the Mkr legend and the relevant readings are not displayed, press the *[Marker]* key. They will appear at the bottom of the screen with the Mkr legend highlighted. The position of the marker along the time axis of the display can be adjusted using the variable control.

When the marker is displayed and the Mkr legend highlighted, pressing either the *[Ref Level]* key or the *[Trig Level]* key will highlight the appropriate legend and transfer the variable control operation from the marker to the highlighted function.

When the marker is displayed and the Mkr legend highlighted, pressing the *[Marker]* key will remove the marker and its readings from the display.

When the marker is displayed but the Mkr legend is not highlighted, pressing the *[Marker]* key will transfer the variable control operation to the marker, and highlight the Mkr legend.

Trigger level

The transient capture operation is started by the signal level passing through the set Trigger Level. The set Trigger Level is relative to the Ref Level (top of display). This is set by pressing the *[Trig Level]* key to highlight the Trigger Level legend, then either entering a new value using the data input keys or by using the variable control. The Trigger Level can be set to any point within the dynamic range of the current display.

Positive or negative triggering

The transient capture operation can be initiated by either a rising or falling signal. Repeated presses of the *[+/- Trig]* key alternates the selection. The state of the current setting is shown as either +ve edge or -ve edge.

Pre-trigger display

The user can select the proportion of the display given to pre-trigger activity. Repeated presses of the *[Pre Trig]* key will step through 0 %, 25 %, 50 %, 75 % and 100 % values. 0 % will cause the display to commence (on the left of the screen) at the time of trigger, 50 % will place the trigger point center screen with pre-trigger levels shown to the left and post-trigger levels shown to the right while 100 % will cause the display to finish (on the right of the screen) at the time of trigger. 25 % and 75 % will produce displays with these proportions of pre-trigger visible. The trigger point is indicated on the display by a medium pecked line.

Transmitter frequency

The frequency of the transmission to be analyzed can either be set manually or transferred from the previous test mode used.

When the transient analysis function is accessed, the transmitter frequency set in the Tx TEST mode is taken as the transmitter frequency for analysis.

If the SPEC ANA mode is accessed and the span changed to use a new center frequency, this will become the new transmitter frequency for the Tx TEST mode and therefore the transmitter frequency for the transient analysis function.

Time scale

The time scale of the display is adjustable from 50 μ s/division (500 μ s full scale), to 5 s/division (50 s full scale). Repeated presses of the *[▶▶]* key will progressively increase the time/division in a 1, 2, 5 sequence. Using the *[◀◀]* key will similarly cause the time/division to decrease.

Arming, triggering and storing

The transient capture operation has three phases. The current phase is shown in inverse video at the bottom right of the display.

The **Armed** phase is active when the transient analysis function is accessed. The level of any signal entering the selected RF input connector at the set transmitter frequency is displayed on the screen, if it is within the dynamic range currently being displayed.

Samples of the level of the signal displayed are stored in a circular buffer, configured to be filled within the time of one display scan.

While in the **Armed** phase, the display is re-initialized if a setting is changed which could otherwise result in an erroneous display being produced. The settings which cause re-initializing when changed are:-

- Reference level
- Transmitter frequency
- Display time scale
- Pre-trigger.

The **Triggered** phase is activated by the RF level passing through the trigger level in the selected direction.

Writing to the circular buffer is stopped after the elapse of the post-trigger time to be displayed.

When the display is complete, it will show the profile of the transmitter level transient. This starts the **Stored** phase. Fig. 3-8, shows transient records of the same signal transient at Time/div settings of 50 ms, 500 μ s and 50 μ s.

LOCAL OPERATION

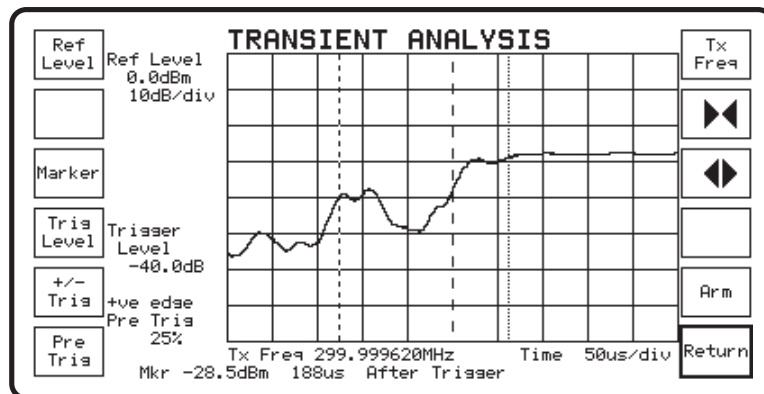
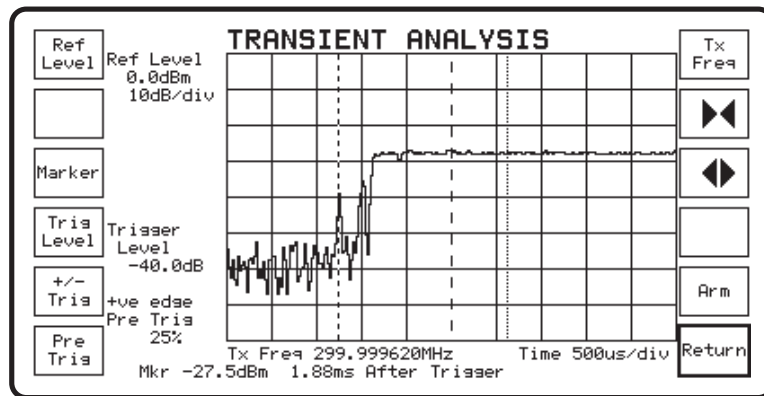
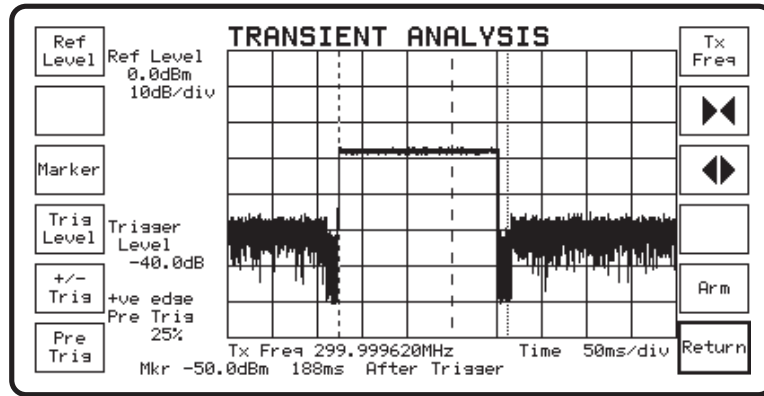

B3122

Fig. 3-8 Transient Analysis displays

From this condition a permanent record can be made on a suitable printer by using the [DISPLAY HOLD], [Print], key sequence or stored to a memory card using the [DISPLAY HOLD], [Store], [Store Screen], key sequence.

When the current display is no longer required, the **Armed** phase can be reset by pressing the [arm] key.

Occupied Bandwidth

This optional facility is used to evaluate the bandwidth occupied by the output from a transmitter. The display is a modified presentation of the spectrum analyzer display. For more information about the Spectrum Analyzer facility refer to the *Spectrum Analyzer* section of this chapter starting on page 3-55 .

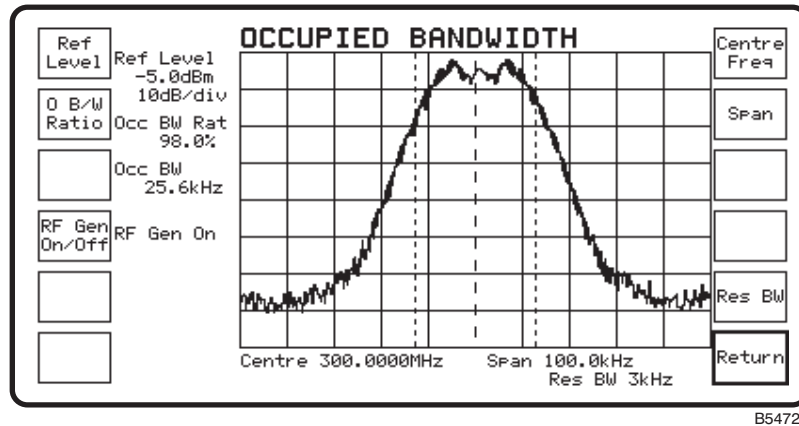

B5472

Fig. 3-9 Occupied Bandwidth display

The Occupied Bandwidth facility is accessed from the Tx Test mode or from the Duplex Test mode, by pressing the [Tx Power] soft key and then the [Occ B/width] soft key. The OCCUPIED BANDWIDTH screen is then displayed. See fold out diagrams (2.0) and (4.0).

The facility produces a measurement of the occupied bandwidth of a signal from a transmitter by evaluating the spectral display of the signal. The result of the measurement is shown on the display as:-

Occ BW nn.nkHz.

The parameters that can be set are:-

[Ref Level] Selects the RF Signal Reference Level setting and allows the value to be set using the data keys, the variable control or the increment keys. For an accurate result the signal peak should be within the top 10 dB division.

[O B/W Ratio] Selects the Occupied Bandwidth setting and allows the value to be set using the data keys or the variable control. The settable range is 90.0 to 99.9%.

[RF Gen on/off] Enables or disables the output from the RF generator within the Test Set. This signal may be used within the overall test setup and the ON/OFF key is provided for controlling it without the need to leave the Occupied Bandwidth facility.

[Centre Freq] Selects the Center frequency setting for the display and allows the value to be set using the data keys or the variable control. The set value will usually be the RF Carrier Frequency of the signal being measured.

[Span] Selects the Span setting for the display and allows the value to be set using the data keys, the variable control or the increment keys. For an accurate result the span setting should be set to give a display of the signal under investigation that has the obvious extent of the signal remaining visible with the minimum of the noise floor included. The measurement will only work over the displayed span, any signal power outside of this will be ignored.

[Res BW] Allows the Resolution Bandwidth of the display to be optimized. Automatic or manual selection is available.

External attenuators

Compensation for an external attenuator or test fixture included in the RF input path of the monitor can be programmed. The value, in dBs, of the attenuator should be entered in the RF Power Ext Atten: field of setup page 1. The value of the attenuator will then be included in power calculations and the power indicated by the power meter will be that at the input to the external attenuator.

This feature makes use of the extended ranges of the power meter.

The value of the attenuator will also be included in RF level calculations and readouts when in the Rx TEST mode and in Dx TEST mode.

'A' is shown against any signal level which has been calculated to include the external attenuator.

OSCILLOSCOPE

With the oscilloscope facility selected, the POWER bar chart is removed from the display but the digital read-out of the power level is retained.

DUPLEX

With the monitor in the Dx TEST mode the POWER bar chart and digital display remain in the same location and the indications are identical to those given in the Tx TEST mode.

Transmitter frequency

The digits adjacent to the Tx Freq legend on the Tx TEST display refer to the frequency to which the Service Monitor receiver circuits are tuned.

If the frequency of the transmitter is known, this figure can be entered manually. This is done by firstly pressing the [Tx Freq] key in the Tx TEST mode menu and then entering the figure using the data input keys. Complete the entry by use of the appropriate terminator key.

The receiver circuits of the monitor will then be tuned to that frequency and any signal within the IF pass band will be examined. The frequency difference between the set frequency and the true frequency will be displayed as 'offset'.

Hint. When testing a transmitter using sequential tones, it may be necessary to pre-tune the Service Monitor receiver circuits in this way in order to successfully decode the initial tones.

If the transmitter frequency is unknown, or it is to be measured, key up the transmitter and use the key sequence [Tx Freq], [Autotune].

The receiver circuits of the monitor will then carry out a sweep to locate the signal and tune to it. The frequency of the signal is displayed against the Tx FREQ legend.

DUPLEX

The same frequency measurement procedures are applicable when in the Dx TEST mode.

RF distortion, and

Spurious outputs

Distortion of the transmission RF output may be deliberate (modulation is a form of deliberate distortion), it may be due to a fault or because of design limitations. Whatever the reason the distortion produces harmonics or other spurious outputs.

These can be located using the SPEC ANA mode of operation.

By viewing the output signals from the transmitter on a voltage vs frequency plot, any transmissions outside the transmitter's specified bandwidth can be identified.

The use of the SPEC ANA mode is explained fully under that heading.

Modulation characteristics

Modulation frequency response and

Companding/limiting

The requirements of individual users will vary but the principle of the tests will be the same.

A signal having a known level and frequency is applied to the AF input of the transmitter and the level of modulation produced is measured.

To test the modulation characteristics of a transmitter with any degree of accuracy requires that the signal used to provide the modulation is accurately defined.

The Service Monitor has two AF generators for this purpose. The setting up instructions for frequency, level and shape options of these is given under 'Setting Up, AF Generators' above.

The output from the AF generators is available at the AF output connector on the front panel. This signal should be used to modulate the transmitter, by direct connection to the AF input of the transmitter under test.

With the modulation meter options set to correspond with the modulation characteristics of the transmitter, the signal can be examined.

Modulation measurement with the Service Monitor is made using a method which evaluates the positive value and negative value as separate readings. This allows the results of both to be given on the display. The bar chart is a dual display indicating the positive value on the top bar and the negative value on the lower bar. The digital read-out is given in three parts. The normal size legend displays the P-P/2 modulation level, while the individual levels are given in half size numerals.

By making changes to the level of the applied AF signal, the linearity of the modulating circuits can be checked, limiting circuits, companders and voice activated switching circuits can be tested and adjusted.

The dual - positive and negative - readings are particularly useful when checking and adjusting the symmetry of transmitters.

Similarly, by repeating the tests at differing frequencies, the frequency response of the modulating circuits and filters can be plotted and adjusted.

By using both AF generators at different frequencies, or by using squarewave output, intermodulation distortion levels can be explored and transient response examined.

STANDARD OSCILLOSCOPE

The digital oscilloscope facility can be used for modulation testing. When this facility is active within the Tx TEST mode, the Service Monitor demodulator output is applied to the input of the oscilloscope.

The input to the oscilloscope is taken from the demodulators through any selected AF filters. Therefore modulation measurements made using the oscilloscope will include the characteristics of the selected AF filter.

The Y ranges of the oscilloscope are directly calibrated in deviation frequency when FM demodulation is selected and in percent modulation when AM demodulation is selected. The ranges are from 200 Hz/ Div. to 10 kHz/Div. in a 1, 2, 5, sequence and 25 kHz/ Div. FM and 5%, 10% and 20%/ Div. AM.

The X ranges are from 50 μ s/Div. to 5 s/Div. in a 1, 2, 5, sequence.

When the oscilloscope facility is selected, the modulation level bar chart is removed from the display. The digital read-out of modulation level, including the positive and negative readings, is retained. The Modulation frequency digital readout is also retained.

EXPANDED OSCILLOSCOPE

When the expanded oscilloscope is selected, all of the above relating to the standard oscilloscope apply *except* that the positive and negative modulation readings are not displayed.

DUPLEX

All of the above information relating to modulation characteristics and frequency response testing also applies to tests made using the Dx TEST mode. The oscilloscope facility is not available when in Dx TEST mode.

Modulation distortion

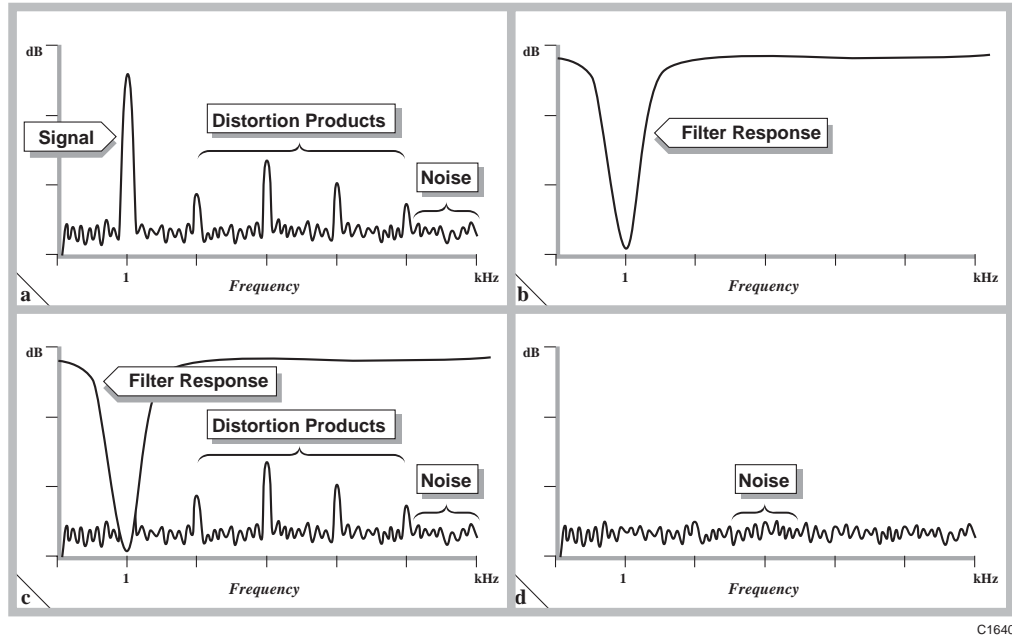

Fig. 3-10 Distortion level and signal to noise level measurements

The signal containing the information being communicated will become distorted during its progress through the system. This distortion may be very slight and almost unnoticeable to the ear or it may be so severe as to cause the information to become unintelligible.

The reasons for this distortion to the signal are the non-linearity of the amplifiers and modulators in the system, and noise within the circuits becoming attached to the signal.

By applying a sinewave signal of known purity to the input of the system and measuring the distortion and noise levels of the demodulated signal obtained at the output of the system, evaluation of the quality of the transmitter is possible.

The three measurements used for this evaluation are SINAD level; distortion percentage; and signal to noise ratio.

The procedures described below are carried out repeatedly under the instruction of the Service Monitor software and the displayed results are continually updated.

To obtain the SINAD level of a signal at the output of a transmitter the output level is measured and noted.

The signal measured consists of the value of the fundamental signal, the values of any distortion products generated and the value of any noise present.

A notch filter tuned to the frequency of the input signal is then placed in the output signal path and the level again measured and noted. The second measurement consists only of the values of any distortion products generated and the value of any noise present. See page 3-36, Fig. 3-10 a, b, & c, *Distortion level and signal to noise level measurements*.

The SINAD level is then calculated according to the formula:-

$$\begin{aligned}\text{SINAD} &= 20 \log \frac{V_1}{V_2} \text{ dB} \\ &= 20 \log \frac{(S+N+D)}{(N+D)} \text{ dB}\end{aligned}$$

To obtain the distortion factor of a signal at the output of a transmitter the output level is measured and noted as for SINAD level measurement.

A notch filter as used for SINAD measurement is used to make a second reading which will consist of the same values as for the second SINAD measurement.

The distortion factor is then calculated according to the formula:-

$$\begin{aligned}\text{Distortion} &= 100 \frac{V_2}{V_1} \% \\ &= 100 \frac{(N+D)}{(S+N+D)} \%\end{aligned}$$

For signal to noise level measurements a reading is taken of the output level as for SINAD level and distortion factor measurements. The AF input signal is then disabled and a second level reading taken. A notch filter is not included in the signal output path. The second measurement will only consist of the value of any noise present on the demodulated signal. See page 3-36, Fig. 3-10 a, & d, *Distortion level and signal to noise level measurements*.

The signal to noise level is then calculated according to the formula:-

$$\begin{aligned}\text{S/N} &= 20 \log \frac{V_1}{V_2} \text{ dB} \\ &= 20 \log \frac{(S+N+D)}{N} \text{ dB}\end{aligned}$$

The distortion measuring system within the Service Monitor has the capability to make all three measurements. Pressing the *[Audio Meter]* key, to change the soft keys as shown in fold out diagram (3-3), then pressing the *[Dist/S-N]* soft key, accesses the distortion measurement menu shown in fold out diagram (3-3-2)

The action of selecting a measurement system returns the TRANSMITTER TEST main (top level) menu to the display.

The result of the selected measurement will be displayed on a bar chart within the transmitter test screen and a digital read-out given above it. When no distortion measurement system is selected, by pressing the *[Off]* key within the distortion measuring menu, the distortion bar chart and digital read-out are removed from the screen.

Hint. By disabling this function, the time taken to measure the remainder of the measurement functions is shortened thereby reducing the update time.

Measurements of SINAD and distortion percentage carried out by the monitor use a frequency of 1 kHz for the tests. When either of these test methods is selected, the system software sets the frequency of the modulation generator to this frequency to avoid erroneous results.

The input signal level influences the readings obtained by the distortion measuring system and is usually specified as part of the test specification.

OSCILLOSCOPE

With the oscilloscope facility selected, the distortion level bar chart is removed from the display but the digital read-out is retained.

DUPLEX

LOCAL OPERATION

When in the Dx TEST mode, modulation distortion tests are not displayed.

Rx test (receiver testing)

Overview

The Communications Service Monitor 2948 has been designed to test the performance of mobile communication equipment. This section explains the use of the Rx TEST mode. Typical uses are:-

- Performance checking following manufacture
- Routine quality assurance testing
- Workshop or field fault diagnosis etc.

The dedicated Avionics SYSTEM function provides signals for testing ILS, VOR and SELCAL receivers. The operation of the Avionics SYSTEM function is explained in Appendix B, *Avionics System*.

The tests which need to be carried out will depend on the specification of the receiver and the reason for testing, however a generalized list would be:-

Sensitivity
AF Bandwidth
AF Distortion
Selectivity
Blocking (or desensitization)
Spurious response
AGC response

With the Rx TEST mode selected, the screen and menu shown in fold out diagram (3-0) is displayed.

From this screen and menu, the setting up of the inbuilt devices for receiver testing, and the read out of results are carried out.

The sections of the monitor available for receiver testing are:-

RF signal generator

Audio modulation generators. Used to provide modulation of the RF generator

Audio tone generator. Provides tones for CTCSS, Sequential, DTMF systems

Audio distortion meter

Digital oscilloscope

As well as setting up the major sections of the Service Monitor, the following parameters are selected from the RECEIVER TEST screen:-

Audio filters

Pre-emphasis filtering

Selection of distortion measuring methods.

Connections

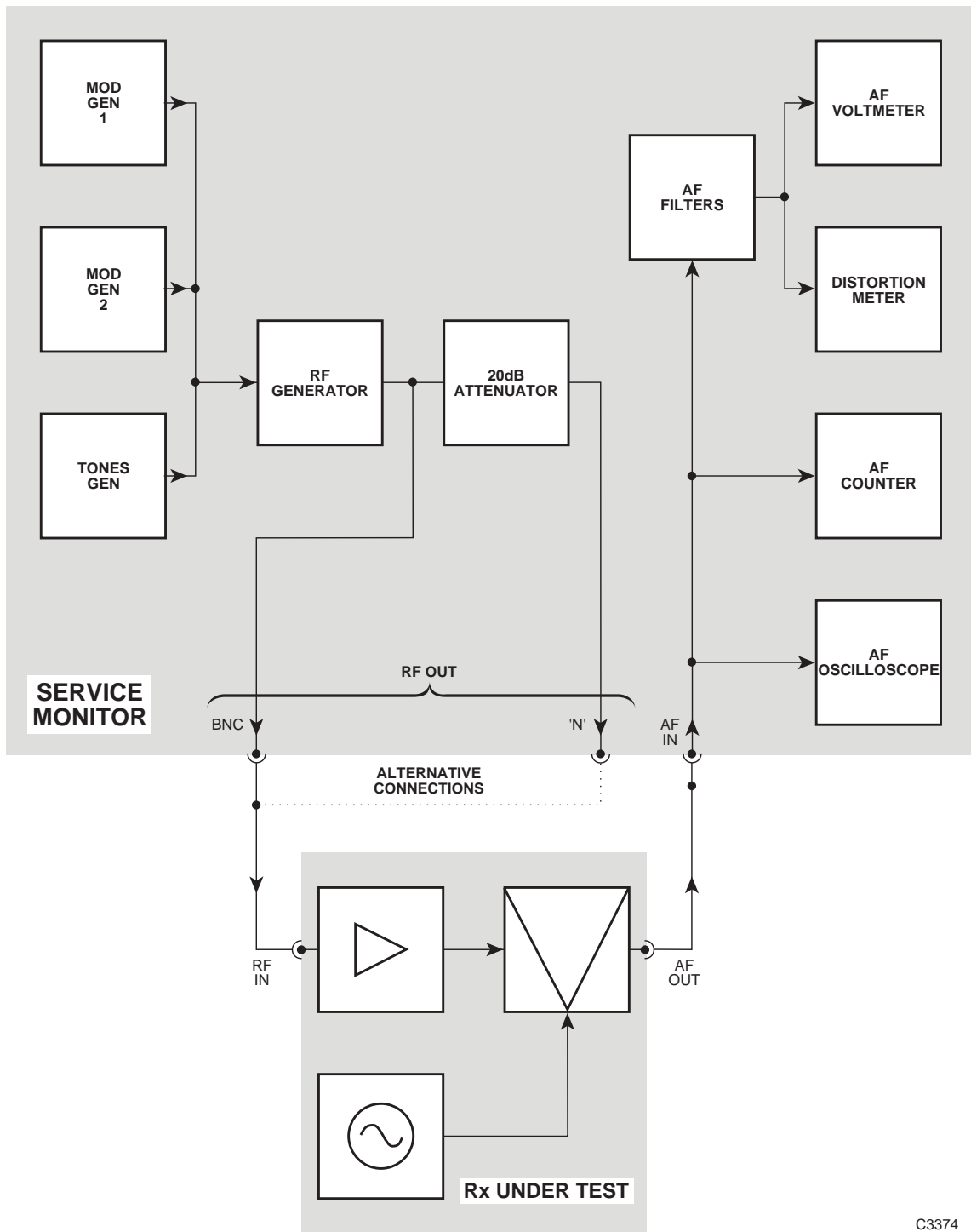

C3374

Fig. 3-11 Receiver test connections

Before making any connections between the Service Monitor and the receiver ensure that the RF generator of the Service Monitor is OFF. With the Rx TEST mode selected, press the [RF Gen] key to highlight the GEN FREQ legend. Pressing the orange [ON/OFF] function key will change the state of the RF generator. OFF is shown adjacent to the indicated generator frequency when the RF generator is disabled.

The RF generator settings can be changed with the generator ON or OFF.

When testing the receiver section of a transceiver, ensure that the power output of the transmitter section will not exceed the power handling capability of the connector on the Service Monitor. Also ensure that the transceiver cannot be switched to 'TRANSMIT' inadvertently.

The receiver and the Service Monitor should be connected as shown in Fig. 3-11 *Receiver test connections*. The block diagram of the Service Monitor shows the signal routing within it.

Points to note are:-

The power source for the receiver should be reliable and stable. The battery of a vehicle may discharge if supplying a mobile transceiver during prolonged testing or the earth connection may become open circuit if the transceiver is removed from its normal location.

When testing the receiver section of transceivers take precautions to prevent the inadvertent 'keying' of the transmitter.

The RF input connection to the receiver should be made using good quality RF cable with correctly fitted connectors. Worn connectors and damaged or kinked cable can produce reflections and losses in the system which will give misleading results.

Setting up

When all the required connections have been made, select the Rx TEST mode to display the screen shown in fold out diagram (3-0).

Set the parameters or options to suit the test requirements, from the RECEIVER TEST menus.

Rx frequency

Range	400 kHz to 1.05 GHz
-------	---------------------

Press the [RF Gen] key.

The GEN FREQ legend is highlighted as shown in fold out diagram (3-1).

If the Rx=Tx function has been set from the Tx TEST mode, the GEN FREQ will be set to the receiver frequency relevant to that test. If this is correct for the receiver under test, there is no need to re-enter the frequency.

Manual frequency setting

With GEN FREQ legend highlighted, data may be entered from the keyboard to the GEN FREQ parameter. Enter the required frequency by using the digit keys and the decimal point key if relevant. The resolution of the RF generator frequency entry is 1 Hz, but it is not necessary to enter every digit down to the least significant place.

The entry is completed by pressing a terminator key. Using the [MHz], [kHz] or [Hz] key causes the entered frequency to be displayed according to normal convention. The following examples explain further.

Pressing:-

[1] [2] [5] [MHz]	will display	125.000000 MHz
[1] [2] [5] [kHz]	" "	125.000 kHz
[1] [2] [5] [0] [kHz]	" "	1.250000 MHz
[1] [.] [2] [5] [MHz]	" "	1.250000 MHz
[1] [2] [5] [0] [0] [0] [1] [Hz]	" "	1.250001 MHz

Variable control

With the GEN FREQ legend highlighted, the GEN FREQ parameter can be adjusted by using the variable control.

Frequency increment

The FREQ [↑] and [↓] keys can be assigned to RF generator frequency adjustment. See *Incremental adjustments* which starts on page 3-68.

Output level setting

Range	
N-Type connector,	-135 dBm to -15 dBm; 0.04 mV to 40 mV pd
BNC connector,	-115 dBm to +5 dBm; 0.4 mV to 400 mV pd (with uncalibrated overrange to +7 dBm)

WARNING

Hot surfaces

Take care when touching the RF Input Type N connector after the application of high levels of continuous power. If 50 W is applied for a prolonged period, the temperature of the connector can become excessive.

The signal generator output level is set using the data keys. It can be defined in dBm with the [dBm] terminator key, by voltage level with the [V], [mV] or [μ V] terminator key or in dB μ V with the [dB] key.

Voltage levels and dB μ V levels will be shown as PD or EMF, depending on the selection made on setup page 1. The output range from each connector is given in the *Performance data* section of chapter 1.

The signal generator output level from the BNC connector is calibrated up to +5 dBm. The output level can be increased to approximately +7 dBm, uncalibrated.

Note that any external attenuator values entered on setup page 1 will reflect in the level of indicated output. If an external attenuator value is currently set, output levels which have been modified to take account of the additional attenuation will be indicated on the display by **A** against them. See *RF Power Ext Atten : dB*, on page 3-12.

To enter an output value press the [RF Gen] key, followed by the orange [LEVEL] function key. The **GEN** and **LEVEL** legends will be highlighted.

Enter the required value using the data entry numeric keys and the relevant terminator key. The level will be displayed in correct engineering convention.

Variable control

With the **GEN** and **LEVEL** legends highlighted, the GEN LEVEL parameter can be adjusted by using the variable control.

Level increment

The LEVEL [\uparrow] and [\downarrow] keys can be assigned to RF generator level adjustment. See *Incremental adjustments* which starts on page 3-68.

Attenuator hold

The Service Monitor has an attenuator hold facility that allows for a 'seamless' range of RF output level. This has a minimum range of 10 dB with a maximum range of 20 dB at certain selected points of the output range. The facility is enabled and set from Setup Page 2 of HELP/SETUP.

Modulation

The RF signal generated for receiver testing can be modulated using either or both of the AF generators or by an external source.

Modulation type

The modulation type is automatically set, to be appropriate to the level terminator key used (FM for Hz, kHz or MHz; AM for %).

Modulation generators

Set up one or both of the modulation generators for the required frequency, level and shape by using the soft keys and data input keys. When these and the de-emphasis filter are set to the required settings press the *[Return]* key to restore the RECEIVER TEST menu.

Modulation frequency and level

The frequency range and level must not exceed the following limits:-

Modulating freq. range	20 Hz to 20 kHz
AM depth range	0 to 99% total sum of active modulation sources
FM deviation range	0 to 75 kHz total sum of active modulation sources

To enable or set up the modulation generators press the *[Mod Gen]* key. The screen and menu shown in fold out diagram (4-2) will be displayed.

Set up the modulation generator(s) for the required frequency and output level by using the soft keys and data input keys:-

[Gen 1/Gen 2] to select MOD1, then, [FREQ][n]...[n][kHz/Hz]
 [LEVEL][n]...[n][kHz/Hz]
 then *[Gen 1/Gen 2]* to select MOD2 if required,....[.../Hz]

Frequency and level increment

The FREQ [\uparrow] and [\downarrow] and the LEVEL [\uparrow] and [\downarrow] keys can be assigned to the modulation generator frequency and level. See *Incremental adjustments* which starts on page 3-68.

Modulation generator state

Either or both generators can be switched off to suit the test requirement. To disable a generator, first select it using the *[Gen 1/Gen 2]* key. Repeated presses of the orange [ON/OFF] function key will disable or enable the selected generator.

Note that the modulation generators are also used as AF generators to provide a modulation source in the Tx TEST mode.

If both AF generators are set to ON in the Tx TEST mode, switching to Rx TEST mode will show both modulation generators to be OFF.

Either or both generators can be set up and turned on within the Rx TEST mode.

The frequency, level and shape settings of their last use in the Rx TEST mode will be retained within the Rx TEST mode setup. These settings will be effective when the generators are switched to ON in the Rx TEST mode. Their use as audio generators in the Tx TEST mode will then be disabled.

Modulation generator shape

The shape of the output waveform from each modulation generator can be set to either sine or square wave. To change the output waveform from a generator, first select it using the *[Gen 1/Gen 2]* key. Repeated presses of the *[Shape]* key will toggle between sine or square wave.

Modulation generator level locking

Pressing the *[Lock]* key locks the output level of the two modulation generators to the same level. The unselected generator locks to the level of the selected generator.

Pre-emphasis filter

The pre-emphasis filter can be switched in or out of circuit after pressing the *[Mod Gen]* key.

Pressing the *[Pre-emph]* key will toggle the pre-emphasis filter into and out of circuit. The time constant of the filter is 750 μ s, giving an increase with frequency of 6 dB/octave.

The legend Pre-emph ON is displayed when the filtering is in circuit. No indication is given when the filtering is out of circuit.

External Modulation

An external modulation source may be used to modulate the RF generator signal. Pressing the *[Ext Mod]* key will display the external modulation input selection menu.

The options available are:-

[DC Ext]	Selects the 'EXT MOD IN' connector on the rear of the Service Monitor, with DC coupling.
[AC Ext]	Selects the 'EXT MOD IN' connector on the rear of the Service Monitor, with AC coupling .
[Mic]	Selects Microphone, (connected to the ACCESSORY socket on the front panel) as the external modulation source.

The selection is shown on the display next to the Ext Level Source legend. The frequency range for each input option is specified in the *Performance data* section of Chapter 1.

The level of the external modulation signal should be 1.0 V rms. This retains correlation of the modulation level indicated on the display with that applied to the RF signal.

Setting external modulation level

Press the *[Ext Mod]* key, which as well as displaying the menu mentioned above, will highlight the **EXT LEVEL** legend. Use the data input keys to set the required level, followed by the appropriate [Hz], [kHz] or [%] key.

Hint. The modulation source level can be measured using the AF INPUT connector on the front panel and AF LEVEL bar chart, or by monitoring the modulation level of the RF generator using the Dx TEST mode.

Microphone input

A microphone suitable for connecting to the accessory socket, is available as an optional accessory. See *Options and accessories*, in the *Performance data* section of Chapter 1.

The microphone input circuit contains a limiter to prevent over-modulation, and the external modulation level setting remains effective when the microphone option is selected. This gives versatility of test options to suit the user's requirements.

The microphone input must be selected to make use of the PTT switching facility available in the Tx TEST mode.

The level of the modulation from the external source will add to the level of any internal modulation and will therefore be included in the total sum of modulation sources.

The state of the external modulation source can be changed by pressing the orange [ON/OFF] function key when the **EXT LEVEL** legend is highlighted. Off is displayed next to the external modulation parameters when the external modulation is disabled.

Note that only one type of modulation can be applied to the RF signal. For example:-

If the [%] terminator key is used to complete a modulation setting when an FM deviation level is already set from another source, the latest selection will cause the previous setting to be cancelled.

AF input level measurement

The measured level of signals applied to the AF INPUT connector can be displayed in volts, dBm, dBV or mW. The selection is made from setup page 2, as described under *Audio Level Measured in:* on page 3-13. When the input level is displayed in dBm or mW, the signal is assumed to be measured across 600 Ω.

The 600 Ω interface unit allows the Service Monitor to provide a 600 Ω termination. (See *Audio Input Impedance:* on page 3-13.) With the input impedance set at 600 Ω, the indicated level is that of the input to the Service Monitor. With the input impedance set at High, the indicated level is that of the input to the Service Monitor with an assumed 600 Ω load.

AF filters

The AF signal to the AF INPUT connector on the front panel can be filtered using high pass, low pass or band pass audio filters and with weighting filters as required.

Press the *[AF Filter]* key. The left hand soft keys change, to allow selection of AF filters as shown below. Press the *[Return]* key after selecting the required filter.

High Pass	Low Pass	Band Pass	CCITT [†] or C-MESS [‡]
-----------	----------	-----------	--

[†] Only if option 23 (CCITT filter) is fitted.

[‡] Only if option 24 (C-MESS filter) is fitted.

The high pass filter options are 50 Hz or 300 Hz.

There are five low pass filter soft keys. The 50 kHz LP filter can be considered to be the 'unfiltered' selection as this represents the normal full bandwidth of the audio circuits.

The other four low pass preset filters can each be set to any cut-off frequency within the range 250 Hz to 1.0 kHz and 3.0 kHz to 20.0 kHz.

The band pass preset filters can be customized by selecting either of the high pass options in combination with any of the four preset low pass filters.

The preset filters are set from the HELP/SETUP facility. The AF Filter setup explanation starts on page 3-10.

OSCILLOSCOPE

The input to the oscilloscope is taken directly from the AF input connector on the front panel, not through any of the AF filters. Therefore measurements obtained on the AF voltmeter will show the effects of filtering, whereas those made using the oscilloscope will not.

Audio distortion

The Service Monitor is able to measure signal noise and distortion against the following parameters:-

Signal to noise ratio	SINAD level	Percentage distortion
--------------------------	----------------	--------------------------

Distortion levels introduced into the audio signal path can be measured using the distortion measuring module.

Pressing the *[Audio Meter]* key, to change the soft keys as shown in fold out diagram (3-3), then pressing the *[Dist/S-N]* soft key, accesses the distortion measurement menu shown in fold out diagram (3-3-2). The function of each soft key on this menu is as follows:-

Off

Disables any active distortion measuring function and removes the distortion bar chart from the display.

Hint. By disabling this function, the time taken to measure the remainder of the measurement functions is shortened thereby reducing the update time.

S/N

Selects Signal to noise ratio as the measurement method. Compares the level of the demodulated signal together with the system noise, against the level of the system noise only, using the formula:-

$$\begin{aligned} \text{S/N} &= 20 \log \frac{V_1}{V_2} \text{ dB} \\ &= 20 \log \frac{(S + N + D)}{N} \text{ dB} \end{aligned}$$

See Fig. 3-10 a & d, *Distortion level and signal to noise level measurements*, on page 3-36. The distortion bar chart is graduated in dB and is also displayed as a digital read-out above the bar chart. The Rx test menu is recalled automatically after pressing this key.

SINAD

Selects SINAD as the measurement method. The modulation generator is set to 1 kHz. By filtering the demodulated signal with a 1 kHz notch filter and comparing the result with the unfiltered signal, the SINAD level is established using the formula:-

$$\begin{aligned} \text{SINAD} &= 20 \log \frac{V_1}{V_2} \text{ dB} \\ &= 20 \log \frac{(S + N + D)}{(N + D)} \text{ dB} \end{aligned}$$

See Fig. 3-10 a, b, & c, *Distortion level and signal to noise level measurements*, on page 3-36. The distortion bar chart is graduated in dB and the SINAD level is displayed as a digital readout above the bar chart. The Rx test menu is recalled automatically after pressing this key.

Dist'n

Selects distortion percentage as the measurement method. The modulation generator is set to 1 kHz. By filtering the demodulated signal with a 1 kHz notch filter and comparing the result with the unfiltered signal, the distortion percentage level is established by the formula:-

$$\begin{aligned} \text{Distortion} &= 100 \frac{V_2}{V_1} \% \\ &= 100 \frac{(N + D)}{(S + N + D)} \% \end{aligned}$$

See Fig. 3-10 a, b, & c, *Distortion level and signal to noise level measurements*, on page 3-36. The distortion bar chart is graduated in % and the distortion percentage level is displayed as a digital readout above the bar chart. The RX TEST menu is recalled automatically after pressing this key.

Making measurements

(Examples of receiver tests).

The procedure for making each of the tests listed in the receiver testing overview, above, follows. Some of the tests may require separate operations and others will only require a reading to be made.

Sensitivity

Receiver sensitivity is defined as the minimum RF level required at the antenna to produce an intelligible output of the modulated information.

The problem with the above definition is that of defining 'intelligible output'. As this is a subjective decision, sensitivity specifications require certain parameters to be set down. The nature of FM and phase transmissions makes sensitivity measurements less straightforward than with AM transmissions. A sensitivity test on an AM receiver can be stated as 'X watts audio output from Y μ V RF input at Z% modulation'.

As there is no direct/linear relationship between RF signal level and audio output with FM receivers, most manufacturers normally quote receiver sensitivity in one of the following four ways:-

12 dB SINAD sensitivity.

20 dB weighted SINAD sensitivity.

20 dB signal to noise sensitivity.

20 dB quieting sensitivity.

When defined as part of a specification, the sensitivity will be given in the form:-

'Sensitivity (12 dB SINAD) 0.25 μ V'

or

'Sensitivity (20 dB SINAD) 1.0 μ V EMF'

or

'12 dB (minimum) SINAD for 0.31 μ V (pd) signal input (at 60% of maximum system deviation and 1 kHz modulation).'

The test method for each of the above sensitivity specifications varies, but the common features are that each requires a signal of accurately defined level, modulation frequency and modulation level to be injected into the receiver, the AF output level referenced, the modulation or a portion of it, to be removed and the audio level re-referenced.

To carry out each of these tests using Service Monitor proceed as follows:-

12 dB SINAD sensitivity

This test determines the level of the modulated RF signal at which the SINAD measurement is 12 dB. The level of modulation is given as part of the test specification. The standard modulation frequency is 1 kHz.

As the RF signal level is reduced, the 'noise' component of the AF output will become proportionally greater. This will result in the SINAD dB reading becoming closer to zero.

To use this Service Monitor to make a 12 dB SINAD sensitivity test, the Service Monitor is set up to make a SINAD distortion measurement and the RF level progressively reduced until the SINAD level reads 12 dB. The RF level of the signal generator will equal the 12 dB SINAD sensitivity level of the receiver.

For a GO/NO GO test the monitor is set up in the same manner as above. The RF level is set to the specified sensitivity level and the SINAD distortion level observed. A reading higher than 12 dB would indicate GO, while a reading of less than 12 dB (i.e. closer to zero) would indicate NO GO.

20 dB weighted SINAD sensitivity

This test is very similar to the 12 dB SINAD sensitivity test

The differences are firstly that the SINAD level specified is 20 dB and secondly that a psophometric weighting filter is included in the test path. This filter imposes a frequency response characteristic to the signal similar to that of the human ear response.

There are two specifications of filter in common use. One is the European standard CCITT and the other is the American C-MESS. The specification of the receiver will state the correct filter to select.

The Service Monitor can have a filter meeting one of these specifications fitted as an option.

The test procedure is identical to that for 12 dB SINAD sensitivity except that the SINAD distortion pass level is 20 dB.

20 dB signal to noise sensitivity

This test determines the level of RF carrier which, when unmodulated will produce an AF output level due only to receiver noise, 20 dB below the AF level produced when modulated at the specified level and at the specified frequency.

As the RF signal level is reduced, the 'noise' component of the AF signal will become proportionally greater. This will result in the Signal to Noise dB reading becoming closer to zero.

To use this Service Monitor to make a 20 dB S/N sensitivity test, it is set up to make signal to noise measurements through the distortion meter menu of the Rx TEST mode. The modulation frequency and level are set according to the receiver's test specification requirements.

The RF level is adjusted until the S/N level indicated on the Service Monitor reads 20 dB. The RF level will then equal the 20 dB S/N sensitivity level.

For a GO/NO GO test the monitor is set up in the same manner as above. The RF level is set to the specified sensitivity setting and the S/N level observed. A reading higher than 20 dB would indicate GO, while a reading of less than 20 dB (i.e. closer to zero) would indicate NO GO.

20 dB quieting sensitivity

This test determines the level of unmodulated RF signal that will produce an AF output from the receiver that is 20 dB lower than the noise level from the receiver when no carrier is being received.

The reduction in AF output when a carrier is being received is due to the action of the automatic gain control circuits in the RF amplifiers of the receiver.

The gain of the receiver will reduce as the level of the RF signal increases. Therefore the noise level will decrease with an increase in RF signal level.

To use this Service Monitor to make a 20 dB quieting sensitivity test the unmodulated RF signal is applied to the receiver at the frequency called for in the test specification. If no frequency is specified, a convenient mid band frequency is selected.

Select *[RF Gen]* from the soft key options. Turn the RF signal off by use of the orange [ON/OFF] function key and note the indicated AF level.

Turn the RF signal ON and adjust the RF level until the indicated AF level is 20 dB less than the previously noted level. The indicated RF level is the 20 dB quieting sensitivity level of the receiver.

For a GO/NO GO test proceed as above until the AF level with no RF input is noted. Then turn the RF signal on and adjust the RF level to the figure specified as the 20 dB quieting sensitivity level. Now observe the AF level indication. A reading greater than 20 dB will indicate GO. A reading lower than 20 dB, (i.e. closer to zero), will indicate NO GO.

Basic sensitivity test

To carry out a basic sensitivity test on an AM receiver:

Set the RF generator frequency to that required by the test program. This setting can be entered using the data input keys or set using the Rx=Tx facility discussed under Tx mode. The RF generator can be switched off during the setup operation if required, by pressing the orange [ON OFF] function key.

Select the 'Mod Gen' menu from the RECEIVER TEST screen.

Set the modulation frequency and level. It is usual to use a single sinewave tone when carrying out sensitivity tests and essential for SINAD tests.

Select the 'pre-emphasis' facility if required, by pressing the *[Pre-emph]* key.

Return to the RECEIVER TEST screen and select the 'AF filter' menu. Select the required AF filtering.

Return to the RECEIVER TEST screen and adjust the RF output level to that required by the test specification.

Switch the RF generator output ON by pressing the orange [ON OFF] function key.

The audio output from the receiver is measured and the level and frequency displayed.

For measuring sensitivity levels, rather than checking against settings, the various parameters on the monitor can be adjusted in steps using the LEVEL [\uparrow] and [\downarrow] keys, or by precision adjustment using the variable control.

AF bandwidth

The audio bandwidth of a receiver should be complementary to that of the transmitter or transmitters associated with it.

The test for audio bandwidth is made by establishing a reference frequency, usually 1 kHz, and reference level, then varying the modulating frequency until the measured audio output level reduces by 3 dB. The 3 dB points above and below the reference frequency will be the limits of the AF bandwidth.

When carrying out audio bandwidth tests the monitor audio filtering should be set to the widest possible, i.e. 50 kHz.

Note that most FM transceivers apply pre-emphasis filtering to the transmitter modulation and de-emphasis filtering to the demodulated signal.

AF distortion

The two methods used for quoting distortion within radio receivers are Distortion Factor and SINAD.

SINAD tests are usually made in conjunction with sensitivity testing (see above), while distortion test results are often quoted within the power output parameter. For example '3 Watts output with better than 10% THD' (total harmonic distortion).

The signal to noise level is also quoted but is a measure of receiver quality, not a true measure of distortion.

The AF distortion measuring facility performs continuous reading and display metering using the selected function, (SINAD or distortion factor). Therefore a distortion test can be carried out by ensuring that the RF generator is tuned to the correct frequency, select the distortion measuring function required and set the levels of the RF and AF generators. The distortion factor or SINAD level is then read from the screen.

To obtain sets of readings relating to differing levels of RF or AF, the levels are reset and the new reading made.

Selectivity

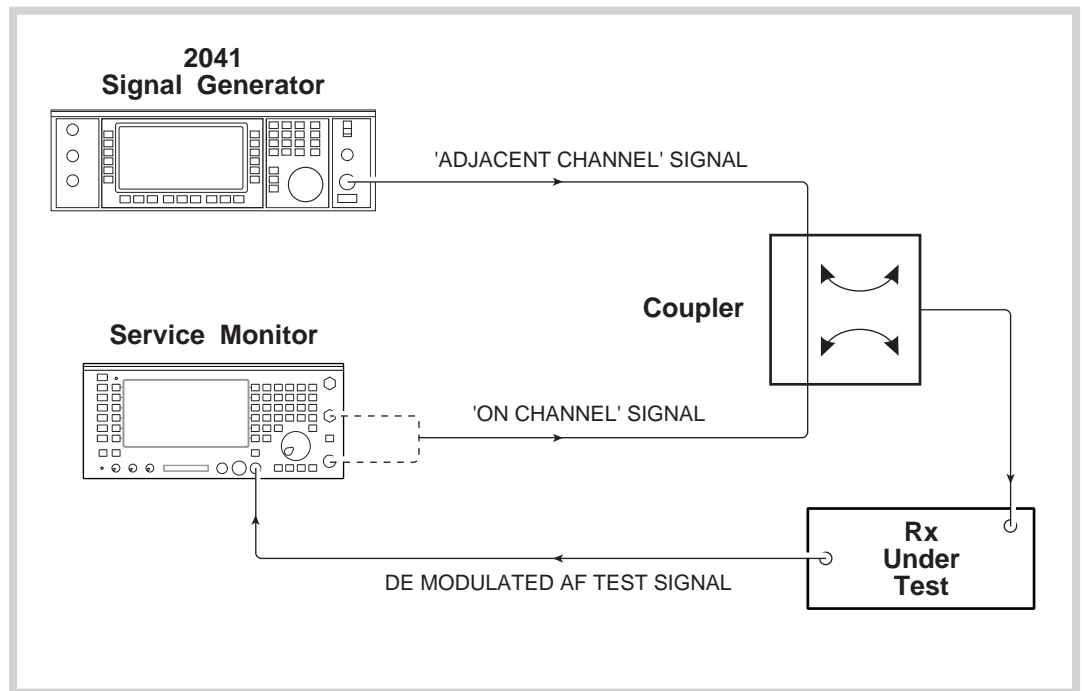

C3375

Fig. 3-12 Selectivity test setup

Selectivity tests are measurements of the capability of a receiver to differentiate between a wanted signal and an unwanted signal, usually that transmitted on an adjacent channel.

This test is carried using the Service Monitor as for previous tests but with a second RF signal generator simulating the adjacent channel transmitter. See Fig. 3-12, *Selectivity test setup*, on page 3-50.

A specification for receiver selectivity requires parameters to be set down to measure against. Within the specification of a typical mobile radio a typical adjacent channel selectivity figure might read: '12 dB adjacent channel selectivity; better than 80 dB', and the 20 dB weighted SINAD sensitivity is quoted as 'better than 1 μ V'.

To confirm this selectivity figure proceed as follows:-

The equipment is connected as in Fig. 3-12, *Selectivity test setup*. The level of modulation for the 'wanted' signal is set to 60% of the maximum deviation for FM receivers or 30% modulation for AM receivers. The modulation frequency is 1 kHz unless specified differently.

The generator being used to provide the adjacent channel signal is set to the frequency of the adjacent channel with a modulation frequency of 400 Hz unless specified differently. The modulation level is set to 60% of the maximum deviation for FM receivers or 30% modulation for AM receivers. The carrier is switched off at the commencement of the test.

The level of the Service Monitor providing the 'wanted' signal is adjusted until a SINAD reading of 20 dB is obtained as for sensitivity testing. The RF output level of the generator should be noted. This should be the same level as that established in the 20 dB sensitivity test (above).

The carrier from the signal generator providing the 'adjacent channel' signal is switched on and the level of its output increased until the SINAD level is reduced to 12 dB. The RF output level should be noted.

The difference in output level of the two RF generators, expressed in dB, is the '12 dB Adjacent Channel Selectivity' level.

In the example above, with a 'wanted' signal level of -90 dB and a 'adjacent' signal level of -7 dB, the performance of the receiver would be satisfactory. If the 'adjacent' signal level was found to read -13 dB the performance of the receiver would be below specification.

Blocking (or desensitization)

Blocking (or desensitization) is an undesirable response by a receiver to a signal whose frequency is spaced from the wanted signal by a frequency difference greater than the adjacent channel spacing. The interfering signal will enter the IF pass band of the receiver with sufficient strength to cause the automatic gain control to operate. This will reduce the gain of the receiver and ‘block out’ weak signals.

The test setup is the same as for selectivity testing.

The generator being used to provide the ‘wanted’ signal is set as for selectivity testing and the level adjusted to produce a SINAD level of 20 dB.

The generator providing the ‘interfering’ signal should be unmodulated and set to an RF level of between 80 and 90 dB above the level of the ‘wanted’ signal

The frequency of the ‘Interfering’ signal should be slowly swept over a range of 1 to 10 MHz either side of the ‘wanted’ signal frequency and the SINAD level observed for any significant variation. If any interaction is found, adjust the frequency of the ‘interfering’ signal for maximum reaction. Vary the level of the ‘interfering’ signal until the SINAD level is 14 dB and note the RF level. This is the blocking level of the receiver for the frequency concerned.

Spurious response

The two types of spurious response measurements normally carried out on a receiver are image frequency rejection and IF rejection.

For a specific receiver type, the frequency of the image signal of a ‘wanted’ signal is twice the receiver intermediate frequency above the wanted frequency if the receiver local oscillator runs at a frequency above the wanted signal, or twice the receiver intermediate frequency below the wanted frequency if the receiver local oscillator runs at a frequency below the wanted signal. See Fig. 3-13, *Spurious response ‘Image Frequency’ location*.

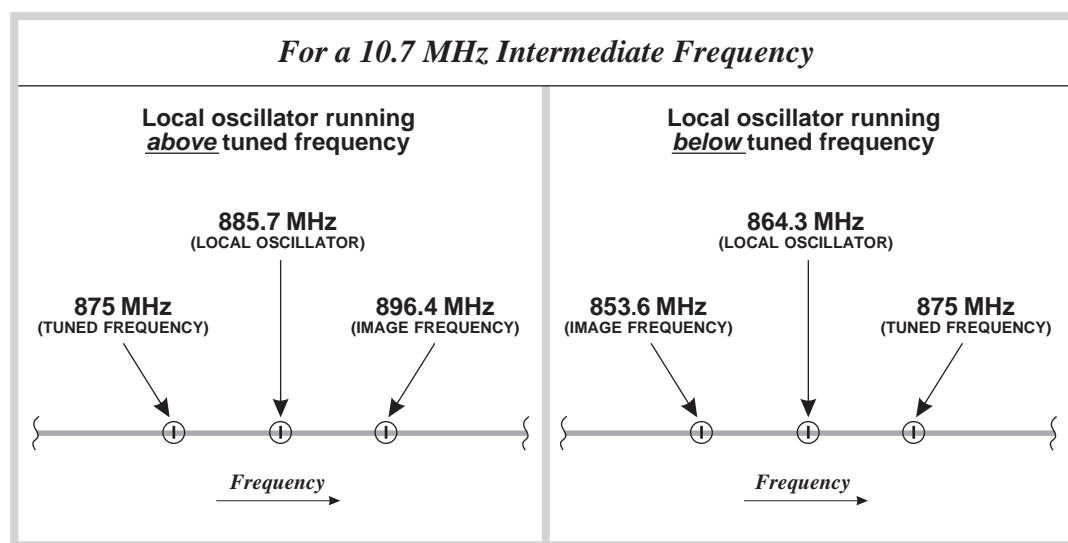

C1614

Fig. 3-13 Spurious response ‘Image Frequency’ location

With the receiver and Service Monitor set up as for sensitivity testing, establish a reference RF input level. Change the RF output frequency of the Service Monitor to the image frequency of receiver tuning point, without altering the receiver tuning. Increase the RF output level of the Service Monitor RF generator until the SINAD level reads 20 dB and note the RF level. The difference in the level of the RF generator readings for the two frequencies, expressed in dB, is the ‘image frequency rejection ratio’.

The procedure for measuring the IF rejection ratio is similar to that used to measure image frequency rejection and uses the same setup. The RF reference level is found at the RF frequency to which the receiver is tuned, then the RF generator is retuned to the IF frequency of the receiver under test. The RF output level is increased until a 20 dB SINAD level is obtained. The output level of the RF generator is noted. The difference in level of the RF generator readings, expressed in dB, is the 'IF rejection ratio' of the receiver.

AGC response

Automatic Gain Control is used in AM receivers to stabilize the level of the audio output signal against changes in the level of RF input. This is necessary as the output voltage from the detector circuit with a constant % depth of modulation is proportional to the level of the RF signal applied to the detector.

To plot the AGC response of a receiver, set up the Service Monitor and receiver as described for receiver audio frequency response tests. The test can be made at one RF frequency only or at various points throughout the receiver tuning range. This will depend on the reason for making the test and the specification of the receiver.

Set the RF generator frequency of the Service Monitor to the selected tuning point of the receiver with the modulation level set to 30% at 1 kHz. Increase the RF output level until an AF output is registered on the Service Monitor display, either bar chart or oscilloscope.

Reduce the RF output level until the AF output level of the receiver reaches the noise level.

Record the RF signal level and the AF output level.

Increase the RF generator level by suitable increments and record the level of AF output at each point.

Continue until the RF input to the receiver reaches the maximum allowed by the receiver specification or until the AF output level no longer increases, whichever occurs at the lowest RF level.

FM receivers incorporate limiting circuits which reduce the level of the RF signal by clipping the extremities of the signal rather than by compression which is necessary with AGC circuits for AM receivers.

Dx test (duplex testing)

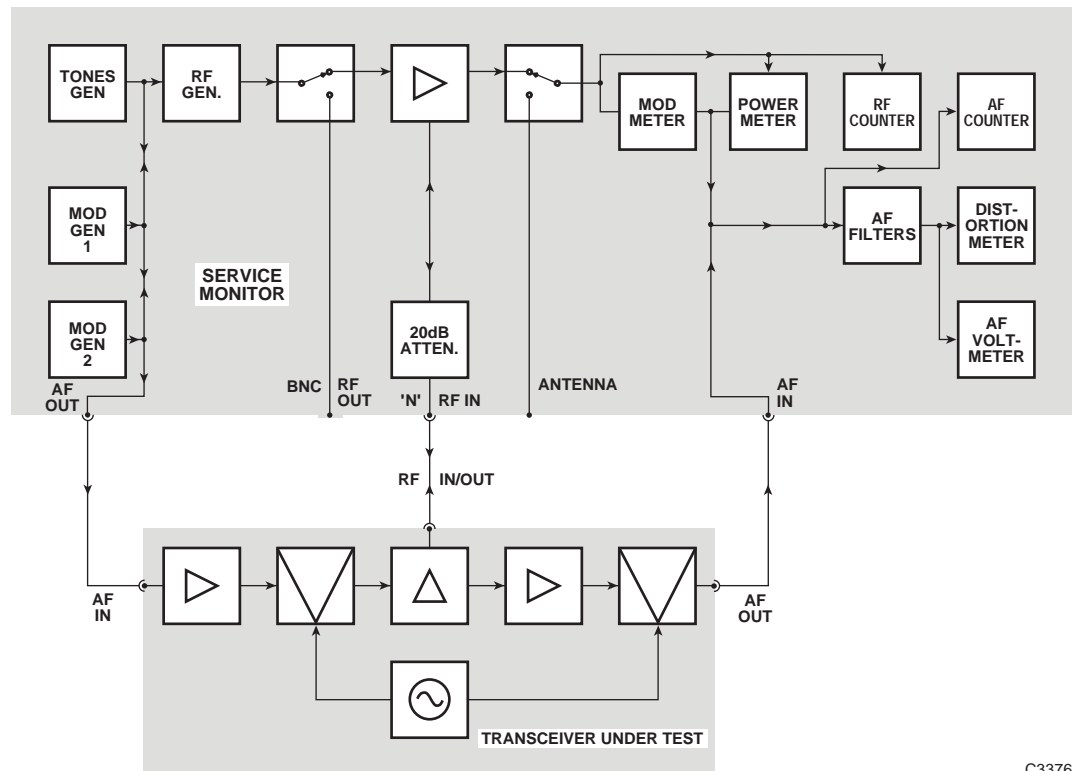

C3376

Fig. 3-14 One port duplex test setup

Overview

With the Dx TEST mode selected, the screen and menu shown in fold out diagram (4-0) is displayed.

The Dx TEST mode is provided so that transmitter and receiver functions of transceiver operation can be studied simultaneously.

‘One port’ and ‘Two port’ transceivers can be tested. See Fig. 3-14, *One port duplex test setup*, and Fig. 3-15, *Alternative two port duplex setups*.

The Dx TEST mode display does not give all the information that is available from the individual Tx TEST mode and Rx TEST mode displays but these displays are available individually by selecting the appropriate test mode.

When interchanging between the Tx TEST mode, Rx TEST mode or Dx TEST mode, any active transmitter test and any active receiver test will remain functional.

There are two exceptions to this.

The first is with the modulation generators used for receiver tests and the audio generators used as a modulation source for transmitter tests. The two AF generators in the monitor serve both functions. Therefore, although both can be assigned to either function, if modulation is required on receiver and transmitter simultaneously, only single tones are possible.

The second exception is that the distortion measuring functions can be made only on the AF signal taken from the receiver under test and fed into the AF input connector of the monitor.

The output from the Tx TEST mode demodulator is fed to the AF amplifier as in Tx test mode. However, as the AF measuring circuits are continually switching functions when in Dx TEST mode, the output from the loudspeaker or headset is discontinuous.

LOCAL OPERATION

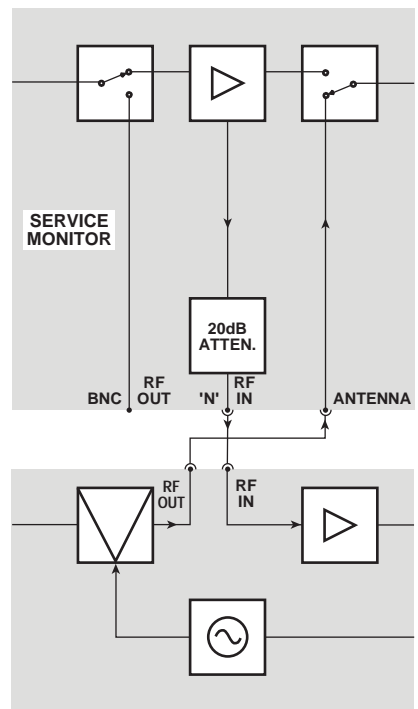
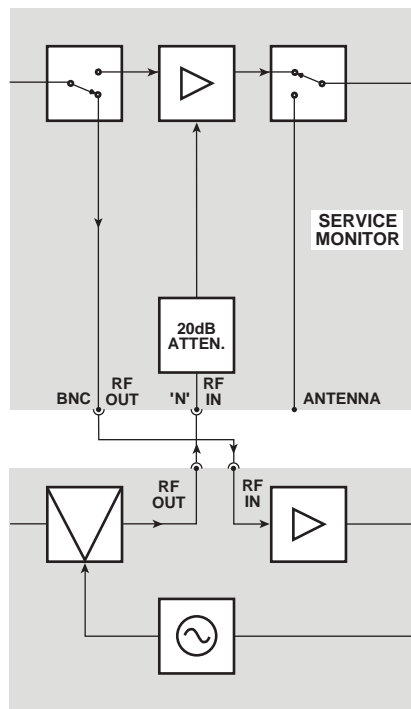
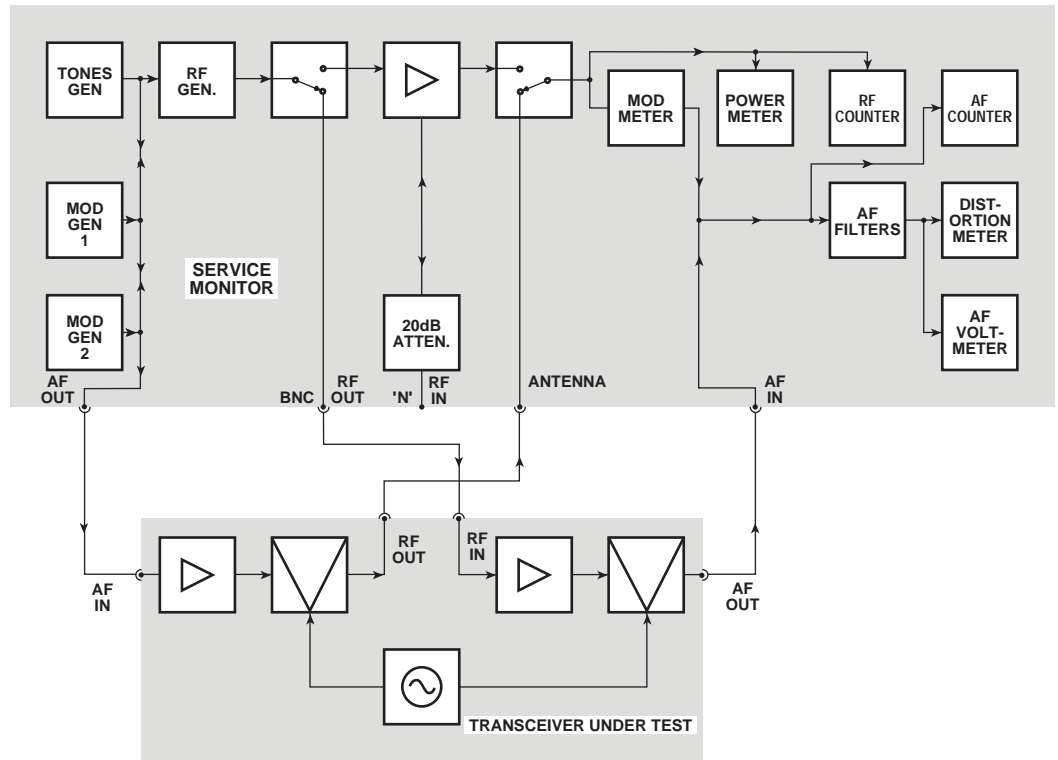

C3377

Fig. 3-15 Alternative two port duplex setups

Systems

The [SYSTEM] mode key gives access to dedicated options for testing mobile communications systems such as AMPS and TACS cellular mobile radio telephone systems and MPT 1327 mobile radio trunking systems. Supplementary operating manuals are provided with Service Monitors fitted with these options.

The same key also gives access to systems specifically designed to test Avionics navigation and communication equipment. Appendix B, *Avionics System*, describes the use of this facility.

Spectrum analyzer

See Fig. 3-16, *Spectrum analyzer test setup*, and Fig. 3-17, *Spectrum analyzer test setup using the tracking generator*.

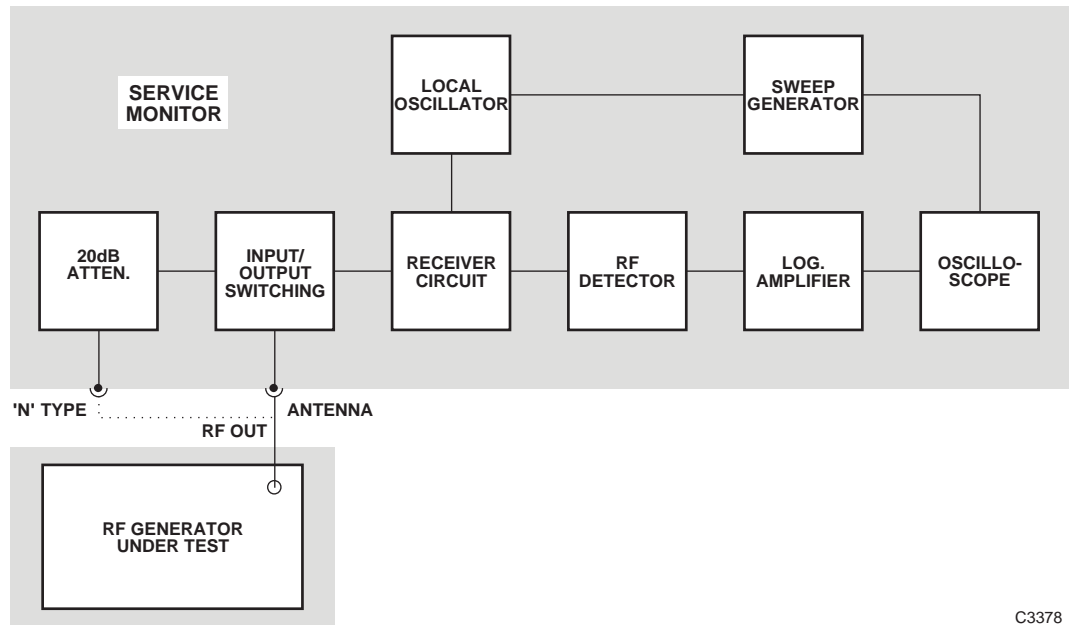

C3378

Fig. 3-16 Spectrum analyzer test setup

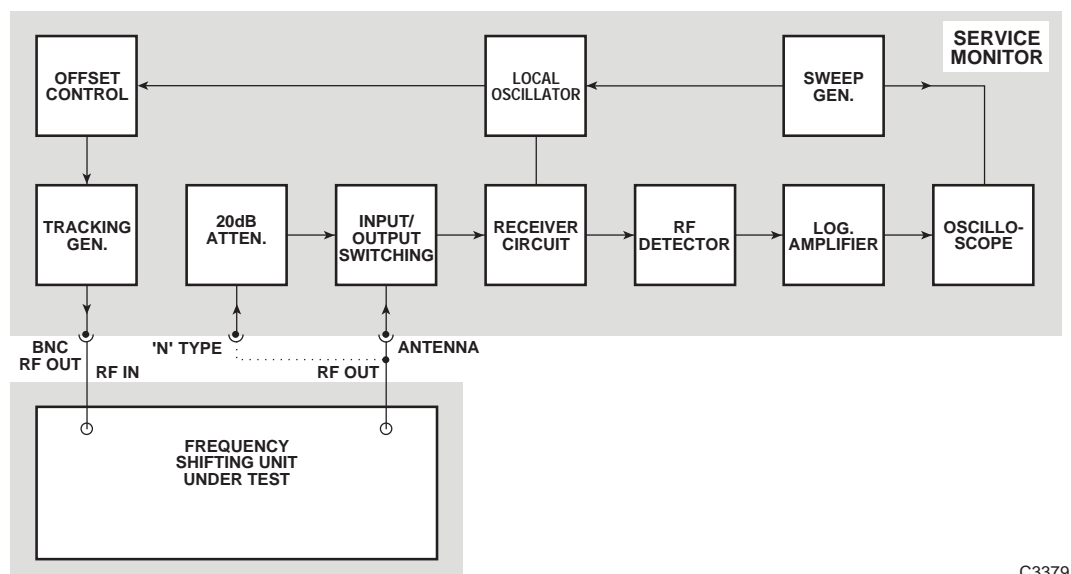

C3379

Fig. 3-17 Spectrum analyzer test setup using the tracking generator.

Overview

With the SPEC ANA mode selected, the screen and menu shown in fold out diagram (6-0) is displayed.

In the SPEC ANA mode, the sweep generator causes the acceptance frequency of the analyzer input circuits to repeatedly sweep over the selected frequency range.

The level of RF signal present at the active RF input connector is measured at regular points along the sweep and plotted progressively across the display, thus building up a graph of RF level against frequency.

The uses to which this facility can be put are varied. Within the radio communication field these can include examining the output of a transmitter for spurious radiations, for sideband response or noise levels.

The activity of nearby transmitters can be monitored as an aid to locating interference.

Using the tracking generator facility, the frequency response of filters can be checked and their pass bands plotted.

Setting up

Sweep range

The sweep range can be defined in two ways: either as a center frequency and a frequency span, or as a start frequency and a stop frequency.

The sweep range will depend on the signal or signals being examined and the harmonics and other spurious frequencies that are to be located.

The datum points are defined using the data input keys in the same manner as other frequency entries such as RF generator frequency or Tx frequency.

The datum point being defined is selected by pressing the relevant soft key, which will cause the datum to be highlighted under the spectrum analyzer graticule on the display. The corresponding datum will also be displayed. Thus START FREQ and STOP FREQ will appear together and SPAN and CENTRE FREQ will appear together.

Center frequency

Pressing the [*Centre Freq*] key highlights the legend **Centre** under the graticule and allows the entry of any frequency within the spectrum analyzer RF range. This frequency will then be the center frequency on the graticule. If a figure is entered which would result in the lowest frequency of the span becoming a negative value, the span is reduced so as to set the span start to zero.

The variable control is active when the **Centre** legend is highlighted. It will not adjust the center frequency to a figure below half of the set span frequency range.

The FREQ [\uparrow] and FREQ [\downarrow] keys can be used to change the center frequency when the **Centre** legend is highlighted. Each press of one of these keys will increment the center frequency by the value last set up in the TxTEST mode.

Span

Pressing the [*Span*] key highlights the legend **Span** under the graticule and allows the entry of any frequency within the spectrum analyzer RF range. This frequency will then be the frequency range covered by the frequency sweep. If the frequency entered conflicts with the center frequency, by requiring a bottom frequency below zero or a upper frequency which is outside the spectrum analyzer RF range, the span will be restricted.

The variable control is active when the **Span** legend is highlighted.

The FREQ [\uparrow] and FREQ [\downarrow] keys can be used to change the span setting when the **Span** legend is highlighted.

Each press of one of these keys will increase or decrease the span setting to the next point in the range 1 kHz, 2 kHz, 5 kHz,.....200 MHz, 500 MHz, 1.0 GHz. The span setting is restricted by the Centre Frequency setting, as explained above.

Start frequency

Pressing the *[Start Freq]* key allows the required start point to be entered using the data entry keys.

The variable control is active when the **Start** legend is highlighted.

Note that when using the variable control the span of the display remains constant. Therefore the stop frequency will follow any change to the start frequency. This is not the case when entering a start frequency by using the data keys.

Stop frequency

The *[Stop Freq]* key highlights the **Stop** legend under the graticule and allows a frequency value to be entered from the data keys.

The variable control is active when the **Stop** legend is highlighted.

Note that when using the variable control, the span of the display remains constant. Therefore the start frequency will follow any change to the stop frequency. This is not the case when entering a stop frequency from the data keys.

Peak find

Press the *[Peak Find]* key to set the marker to the highest level on the trace.

Resolution bandwidth

The bandwidth of the spectrum analyzer acceptance circuits is selectable by the user.

The spectrum analyzer detector circuits will give an output corresponding to the mean level of signal within the acceptance passband. Therefore the choice of pass band, or resolution bandwidth, will depend upon the characteristics of the signal being examined.

The sweep speed is dependent on the resolution bandwidth. A high resolution analysis will take longer to process than a low resolution analysis.

The resolution bandwidth can be selected manually or set automatically.

To set the resolution bandwidth, first press the *[Res BW]* key. The menu shown in fold out diagram (6-12) will be displayed. The options then available are:-

- Press the *[Auto Res BW]* key to set the resolution bandwidth to the optimum setting as determined by the Service Monitor software. The setting is then shown on the display. Use the return key as appropriate to resume setting up or testing.
- Press the *[Manual Res BW]* key to set the required resolution bandwidth by manual selection. The passbands available for selection are:-

300 Hz	3 kHz	30 kHz	300 kHz	3 MHz
--------	-------	--------	---------	-------

The setting is then shown on the display. Use the return key as appropriate to resume setting up or testing.

- Press the *[Return]* key to exit the resolution bandwidth selection menu.

Reference level

The top of the graticule represents the reference level which can be set between -50 dBm and +52 dBm

Pressing the *[REF LEVEL]* key will highlight the **Ref Level** legend and allow a level within the above range to be entered using the data entry keys. The entry must be terminated with the [dBm] terminator key.

Vertical scale

The vertical scale can be displayed with a range of 10 dB/division or 2 dB/division. To select the vertical range, press the *[Vert Scale]* key which will cause the menu shown in fold out diagram (6-2) to be displayed. Repeated presses of the *[10 dB/2 dB]* key will switch the reference level between the options, with the current choice being shown in the display.

The LEVEL [\uparrow] and [\downarrow] keys adjust the reference level in either 2 dB or 10 dB steps, depending on the setting of the reference level vertical range.

Video filter

A video bandwidth filter can be switched into the display signal path to reduce the visible noise. To set the state of this, first press the *[Vert Scale]* key. Alternate presses of the *[Video Filter]* key will set the Video filter ON or OFF.

The filter frequency is selected automatically to provide optimum performance for the selected resolution bandwidth.

Peak hold

The spectrum analyzer mode has a peak hold facility. When set ON, this facility displays the highest received signal level at each frequency point of the display. Signals of a lower level will not over-write the display, signals of a higher level will over-write previously recorded signals.

To set the state of the peak hold facility, first press the *[Vert Scale]* key. Alternate presses of the *[Peak Hold]* key will set the facility ON or OFF.

Markers

Marker and δ Marker

The Marker and δ Marker facility allows frequency and level measurements to be made to the signal displayed on the spectrum analyzer screen. The Marker or δ Marker readout is shown at the lower left of the display. The RF level is given in dBm and the RF frequency in MHz, kHz or Hz.

Pressing the *[Mkr/ δ mkr]* key toggles through the following actions:-

- Displays marker line and marker readout.
- Selects Marker function and allows adjustment using the variable control.
- Selects δ Marker function and allows adjustment using the variable control.
- Removes marker line and marker readout from the display.

With Marker selected and the **Mkr** legend highlighted, adjusting the variable control will move the marker line across the display. The RF level and frequency of the signal at the intersection of the marker line and the displayed signal is shown by the marker readout.

With δ Marker selected and the **δ Mkr** legend highlighted, adjusting the variable control will move the marker line across the display. The marker readout shows *the difference* in RF level and frequency between the intersection of the *marker line* and the displayed signal *and* the intersection of the *display center line* and the displayed signal. A negative frequency value indicates that the marker line is at a frequency lower than the frequency of the display center line.

Marker to reference

Pressing the *[Marker to Ref]* key moves the marker line to the display center line.

- With the Marker function active, the marker readout will display the RF level and frequency of the signal at the intersection of the display center line and the displayed signal.
- With the δ Marker function active, the marker readout will display 0 dBm and 0 Hz until the marker line is repositioned.

Tracking generator facility

The tracking generator facility uses the RF generator of the Service Monitor to provide a tracking signal source.

This allows the spectrum analyzer to show the frequency response of frequency dependent circuits such as filters.

The frequency response of any circuit connected between the tracking generator output and the spectrum analyzer input will be displayed.

Note

When making calculations relating to frequency response results, take into account the impedance matching between the circuit and the Service Monitor. (See performance specification.)

The frequency offset facility adds to the above capability by allowing tests to be made to frequency shifting circuits. The tracking generator's sweep may be positively or negatively offset with respect to the spectrum analyzer's output. The sum of the offset and the frequency analyzer span, cannot produce a figure beyond the frequency range of the RF generator (see performance specification). Under these circumstances, the 2948 selects an appropriate span.

Because the RF generator is used as the tracking generator, control is required over both modes of its operation. The RF generator On/Off menu allows this to be enabled or disabled from the SPEC ANA mode.

Setting the tracking generator

Control of the tracking generator parameters is carried out from the menu accessed by pressing the *[Track/RF Gen]* key. This key will either give direct access to the tracking generator parameters or to the RF generator On/Off menu, whichever was used last. If the RF generator On/Off menu is reached, pressing the *[Track Gen]* key will display the tracking generator parameter control menu shown in fold out diagram (6-5). This menu gives the following options:-

Tracking generator ON or OFF.

Alternate presses of the *[T/Gen On/Off]* key will toggle the tracking generator output ON and OFF. When in the ON condition, the RF level and frequency offset will be shown on the display.

Tracking generator level.

Pressing the *[Level]* key will highlight the **Track Gen Level** legend and allow the level to be altered, either by the variable control or by entering a new value using the data entry keys.

Locking tracking generator frequency to sweep frequency.

Pressing the *[Freq Locked]* key will lock the Frequency of the tracking generator to the sweep oscillator of the spectrum analyzer. When locked, the legend Locked is shown under the Offset legend on the display. Repeated presses of this key will toggle between Locked, (zero offset), and the offset previously set (see below).

Setting the value of the tracking generator frequency offset.

A new value is entered by first pressing the *[Freq Offset]* key and then using the data entry keys.

Additionally, the RF generator may be disabled from the spectrum analyzer tracking generator menu. Pressing the *[RF Gen]* key will display the RF Generator On/Off menu. Repeated presses of the *[RF Gen On/Off]* key will display the RF Gen Off or the RF Gen On legend. This indicates the state of the RF generator when the tracking generator facility is off.

Look and Listen

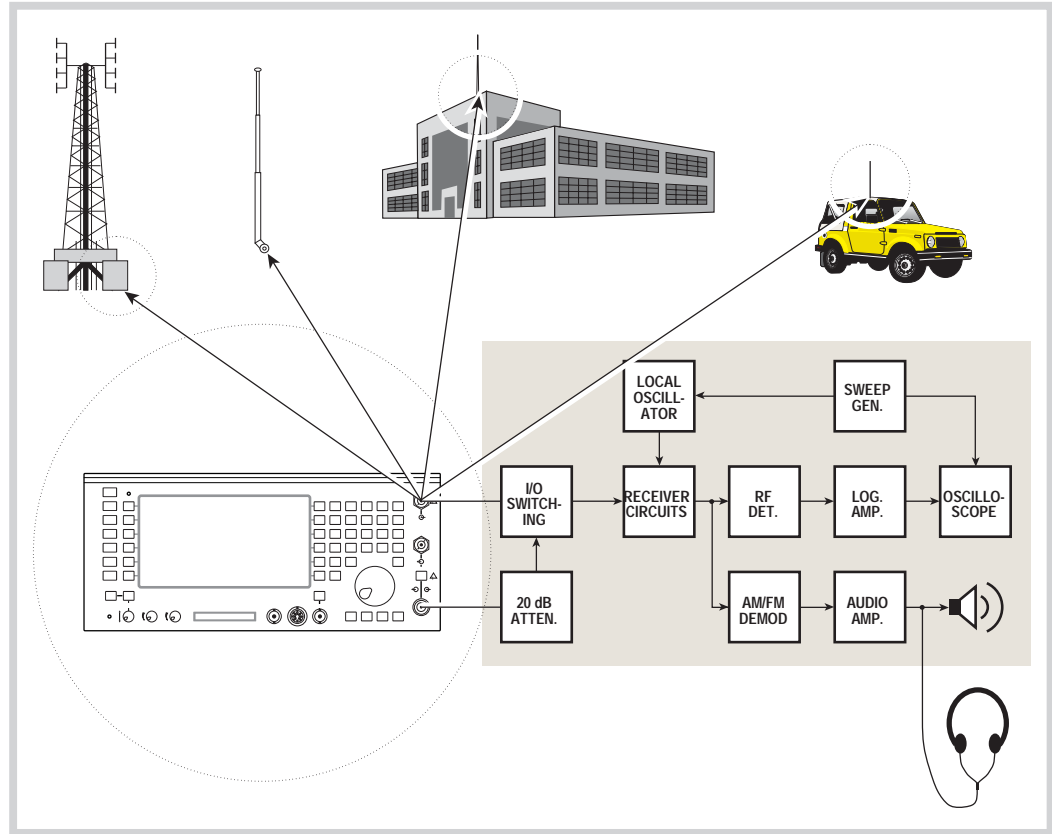

B1417

Fig. 3-18 Spectrum analyzer setup, Look and Listen function

The Look and Listen facility allows the Service Monitor to be used for ‘OFF-AIR’ monitoring of transmissions while examining the area of radio spectrum on which the transmission being monitored is centered. The width of RF spectrum scanned in the Look and Listen mode is adjustable in steps from a minimum of 100 kHz to 1 MHz.

The RF signal from a suitable antenna is coupled to the Service Monitor through either the antenna BNC connector or the ‘N type’ connector on the front panel. The signal is passed through the spectrum analyzer circuits to be displayed as a conventional spectrum analyzer display. The listen demodulator obtains its signal from a non-sweeping IF circuit and is tuned to the center frequency of the display. The output from it is routed through an AF amplifier to the internal loudspeaker, to the accessory socket and to the ‘demod out’ socket. See Fig. 3-18, *Spectrum Analyzer setup, Look and Listen function*.

Setting up

Pressing the [Look & Listen] key from the SPECTRUM ANALYZER menu selects this option. The menu shown in fold out diagram (6-6) is displayed.

Center Freq and Span setting

When operating in the ‘Look & Listen’ mode, the spectrum display is defined only by the Centre Freq and Span settings.

The center frequency is set by selecting the [Centre Freq] key to highlight the legend **Centre** at the bottom of the display and then entering a value using the data input keys. Fine adjustment can be made using the variable control when the **Centre** legend is displayed as above.

With an input signal displayed, adjusting the centre frequency will allow the listen detector to be tuned to an observed signal.

LOCAL OPERATION

The Span setting controls the sweep range covered by the spectrum analyzer. When in the Look and Listen mode the sweep span is selected from the Span menu accessible by pressing the *[Span]* key. Four span widths are available as listed below.

1 MHz	500 kHz	200 kHz	100 kHz
-------	---------	---------	---------

Demod settings

The 'listen' demodulator and its associated circuits are set to extract the information from the signal tuned to the center frequency of the display. The following options are available through the *[Demod]* key.

Modulation type	AM	FM
De-emphasis	ON	OFF
AF filter	300 Hz to 3.4 kHz	15 kHz LP

'Listen' IF bandwidth

The 'Listen' IF bandwidth for the 'Look & Listen' facility can be set to 15 kHz or 300 kHz. This is irrespective of the spectrum analyzer resolution bandwidth selected. The current setting is shown to the left of the display. To change the setting, first press the *[Listen IF BW]* key, which will display *[15kHz]* and *[300kHz]* keys. Press the appropriate key to select the required setting.

Switching to the Tx TEST mode after a signal has been located will allow the signal to be monitored with the IF bandwidth set to 300 Hz, 3.0 kHz, 30 kHz or 300 kHz.

Resolution bandwidth selection

The resolution bandwidth for the display can be selected from the following through the *[Res BW]* key:-

Auto Res BW	3 kHz	30 kHz	300 kHz
----------------	-------	--------	---------

With automatic resolution bandwidth selected, the resolution bandwidth is dependent on the sweep span, as shown below:-

Span Setting	Resolution Bandwidth
1 MHz	30 kHz
500 kHz	30 kHz
200 kHz	3 kHz
100 kHz	3 kHz

When operating in the Look and Listen mode, some functions or options of SPEC ANA mode will be available to the user. Reference to these is made on the display but their condition cannot be changed without returning to the main spectrum analyzer display. These are:-

Reference level dB/div	2 dB	10 dB
Video filter option	OFF	ON
Peak hold option	OFF	ON

Input sensitivity

The input sensitivity of the Service Monitor in the Look and Listen mode is the same as for the normal spectrum analyzer input. The reference level can be set using the data input keys, or adjusted using the variable control. The LEVEL [\uparrow] and [\downarrow] keys adjust the reference level in either 2 dB or 10 dB steps depending on the setting of the reference level vertical range.

Making measurements

The monitor can be used to determine the frequency of a transmission and to identify the modulation type and content of asymmetric transmissions. When the transmission to be examined is visible on the display, adjust the center frequency line on the display to coincide with the peak of the signal. This will be the carrier frequency and will be shown as a digital readout.

Progressively reduce the span and optimize the filtering and demodulation method while listening to the demodulated output. As the span is reduced the center frequency may need optimizing.

The peak level of the signal can be determined by reference to the RF level scale on the display.

The top of the graticule represents the reference set on the display. Each division of the graticule represents either 10 dB or 2 dB, as set in the vertical scale setup menu of the main SPEC ANA mode.

AF test (audio frequency testing)

Overview

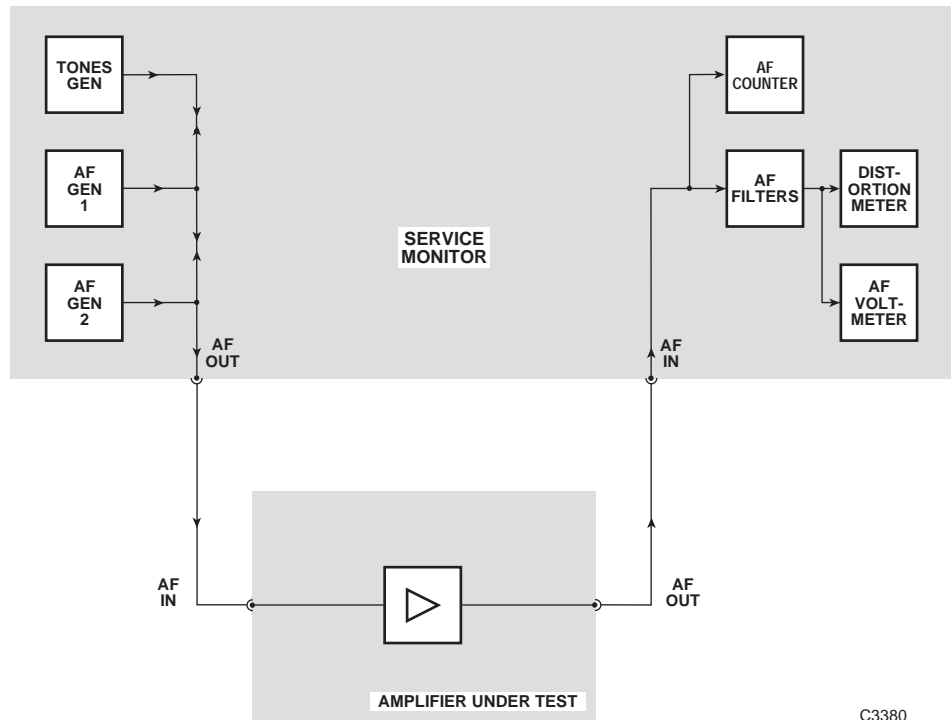

C3380

Fig. 3-19 Audio test setup

To enter the AF TEST mode press the blue [AF TEST] key. This will cause the screen and menu shown in fold out diagram (7-0) to be displayed.

When the AF TEST mode is selected, the combined output from the AF generators, plus the data generator facility, is available at the AF output connector. Signals fed to the AF input connector are routed to the AF signal analyzing circuits. See Fig. 3-19, *Audio test setup*.

The frequency, level and shape parameters of the audio generators can be set within the following limits:-

Freq. range	10 Hz to 20 kHz
Level range	0.1 mV to 4 V RMS
Shape option	Sine or square

By using the AF signal generators and the measuring functions of the Service Monitor, it can be used for performance testing of passive and active AF circuits such as filters and amplifiers.

Frequency, level, distortion level, SINAD level and signal to noise ratio measurements can be made. The oscilloscope facility is available to observe and measure waveforms. The tones receiver facility is available for the performance checking of features such as digitally coded squelch generators.

The AF output signal and the measuring facilities can each be used independently.

Setting up

The audio generators are the signal sources for AF testing. Good practice is to disable the source until tests are set up. This is achieved by selecting each of the generators in turn and pressing the orange [ON/OFF] function key to display Off adjacent to each of the generator's output data on the display. The required generator or generators can be set up in the Off condition and enabled by the above procedure when all connections and setting are complete.

To select and set up the audio generators press the *[Audio Gen]* key. This will display the audio setup menu shown in fold out diagram (7-2).

Repeated presses of the *[Gen1/Gen2]* key will highlight the **AF1** and **AF2** legends in turn to indicate the selected generator.

Set up the audio generator(s) for the required frequency and output level by using the soft keys and data input keys:-

[Gen 1/Gen 2] to select AF1, then, [FREQ][n]...[n][kHz/Hz]

[LEVEL][n]...[n][V/mV/dBm]

then *[Gen 1/Gen 2]* to select GEN2 if required,...[.../dBm]

The FREQ [\uparrow] and [\downarrow] and the LEVEL [\uparrow] and [\downarrow] keys can be assigned to AF generator frequency and level. See *Incremental adjustments* which starts on page 3-68.

The shape of each audio generator output waveform can be either sine or square wave. This is controlled by first selecting the audio generator as for On/Off control above, then pressing the *[SHAPE]* key to toggle between the options.

Input level measurement

The measured level of signals applied to the AF INPUT connector can be displayed in volts, dBm, dBV or mW. The selection is made from setup page 2, as described under *Audio Level Measured in:* on page 3-13. When the input level is displayed in dBm or mW, the signal is assumed to be measured across the impedance selected on the Audio Input Impedance Match selection made from setup page 2. (See *Audio Input Impedance Match* on page 3-13.)

The 600 Ω interface unit allows the Service Monitor to provide a 600 Ω termination. (See *Audio Input Impedance* on page 3-13.) With the input impedance set at 600 Ω , the indicated level is that of the input to the Service Monitor. With the input impedance set at High, the indicated level is that of the input to the Service Monitor with an assumed 600 Ω load.

Input filtering

The AF signal to the AF INPUT connector on the front panel can be filtered using high pass, low pass or band pass audio filters and with weighting filters as required.

Press the [AF Filter] key. The right hand soft keys change, to allow selection of AF filters as shown below. Press the [Return] key after selecting the required filter.

High Pass	Low Pass	Band Pass	CCITT [†] or C-MESS [‡]
-----------	----------	-----------	--

[†] Only if option 23 (CCITT filter) is fitted.

[‡] Only if option 24 (C-MESS filter) is fitted.

The high pass filter options are 50 Hz or 300 Hz.

There are five low pass filter soft keys. The 50 kHz LP filter can be considered to be the 'unfiltered' selection as this represents the normal full bandwidth of the audio circuits.

The other four low pass preset filters can each be set to any cut-off frequency within the range 250 Hz to 1.0 kHz and 3.0 kHz to 20.0 kHz.

The band pass preset filters can be customized by selecting either of the high pass options in combination with any of the four preset low pass filters.

The preset filters are set from the HELP/SETUP facility. The AF Filter setup explanation starts on page 3-10.

Distortion measurement

The distortion measuring facilities of the monitor are available within the AF TEST mode.

Pressing the [Audio Meter] key, to change the soft keys as shown in fold out diagram (7-3), then pressing the [Dist/S-N] soft key, accesses the distortion measurement menu shown in fold out diagram (7-3-2).

Pressing each of the soft keys will have the following effect:-

Off

Disables any active distortion measuring function.

Hint. By disabling this function, the time taken to measure the remainder of the measurement functions is shortened thereby reducing the update time.

S/N

Selects signal to noise ratio as the measurement method. The AF generator is disabled and enabled alternately by the monitor software and the total output level from the circuit under test is measured by the AF voltmeter at each state. See Fig. 3-10 a & d, *Distortion level and signal to noise level measurements*, on page 3-36.

Calculations are performed by the software to calculate the signal to noise ratio using the formula:-

$$\begin{aligned} \text{S/N} &= 20 \log \frac{V_1}{V_2} \text{ dB} \\ &= 20 \log \frac{(S + N + D)}{N} \text{ dB} \end{aligned}$$

The distortion bar chart ranges available are 0 to 30 dB and 0 to 100 dB. The signal to noise ratio is displayed as a digital read-out above the bar chart. The AF test menu is recalled automatically after pressing this key.

SINAD

Selects SINAD as the measurement method. The AF generator is set to 1 kHz and the 1 kHz distortion notch filter is switched alternatively in and out of circuit, with the signal level being measured by the AF voltmeter in each state. See Fig. 3-10 a, b, & c, *Distortion level and signal to noise level measurements*, on page 3-36.

The monitor software calculates the SINAD level according to the formula:-

$$\begin{aligned}\text{SINAD} &= 20 \log \frac{V_1}{V_2} \text{ dB} \\ &= 20 \log \frac{(S+N+D)}{(N+D)} \text{ dB}\end{aligned}$$

The distortion bar chart ranges available are *0 to 18 dB* and *0 to 50 dB*. The SINAD level is displayed as a digital readout above the bar chart. The AF test menu is recalled automatically after pressing this key.

Dist'n

Selects distortion percentage as the measurement method. The AF generator is set to 1 kHz and the 1 kHz distortion notch filter is switched alternatively in and out of circuit, with the signal level being measured by the AF voltmeter in each state. See Fig. 3-10 a, b, & c, *Distortion level and signal to noise level measurements*, on page 3-36.

The monitor software calculates the distortion level according to the formula:-

$$\begin{aligned}\text{Distortion} &= 100 \frac{V_2}{V_1} \% \\ &= 100 \frac{(N+D)}{(S+N+D)} \%\end{aligned}$$

The distortion bar chart ranges available are 0 to 10% and 0 to 30%. The distortion percentage level is displayed as a digital readout above the bar chart. The AF test menu is recalled automatically after pressing this key.

Oscilloscope

The oscilloscope facility can be used from within the AF test mode to examine the signal present at the AF input socket. The sensitivity of the Y axis is adjustable from 10 mV/division to 20 V/division in a 1,2,5 sequence.

The input to the oscilloscope is taken directly from the AF input, and not through any of the AF filters. Therefore measurements obtained on the AF voltmeter will show the effects of filtering, whereas those made using the oscilloscope will not.

A section on the use of the oscilloscope facility starts on page 3-89.

Incremental adjustment keys

General

This section provides information on the use of the incremental adjustment keys. Other sections of this chapter have specific references to these keys; this section gives general information.

The incremental adjustment keys are located under the variable control, with one pair designated **FREQ**, [↑] and [↓], the other pair designated **LEVEL**, [↑] and [↓]. Each pair can be assigned to a selected parameter within a test mode, which then allows that parameter to be adjusted in steps.

Note that the **FREQ** [↑] and [↓] keys, and the **LEVEL** [↑] and [↓] keys, do not have to be assigned to the same generator.

The parameters that can be selected are:-

Parameter	Test mode
Tx frequency	Tx test mode
AF generator 1 frequency	Tx test mode
AF generator 2 frequency	Tx test mode
AF generator 1 level	Tx test mode
AF generator 2 level	Tx test mode
RF generator frequency †	Rx test mode
RF generator level	Rx test mode
Modulation generator 1 frequency	Rx test mode
Modulation generator 2 frequency	Rx test mode
Modulation generator 1 level	Rx test mode
Modulation generator 2 level	Rx test mode
AF generator 1 frequency	AF test mode
AF generator 2 frequency	AF test mode
AF generator 1 level	AF test mode
AF generator 2 level	AF test mode
RF center frequency	Spec ana.
RF frequency span ‡	Spec ana.
RF level ‡ ‡	Spec ana.

† The RF generator can be made to step up or down through each channel of a mobile radio system type, by setting the Δ frequency to the channel spacing frequency.

‡ The SPEC ANA mode SPAN adjustment using the **FREQ** [↑] and [↓] keys, sets the span to predetermined values. These are not adjustable by the user. See Setting up; SPAN on page 3-56.

‡ ‡ The SPEC ANA mode RF LEVEL adjustment using the **LEVEL** [↑] and [↓] keys, changes the RF reference level in steps of 1 display division. This can be either 2 dB/div or 10 dB/div, dependent on the value of dB/div set in the SPEC ANA mode.

Assigning

The assignment of the incremental keys is shown in the display, along with the step value.

To assign a parameter to a pair of keys, first select the parameter as if to change the value using the data input keys, but rather than entering a new value press the orange [ALT Δ] key. Now enter the value of the step to be incremented at each keypress, followed by the correct terminator key.

For example to assign the FREQ [↑] and [↓] keys to AF generator 1 in the Tx TEST mode and to step up or down by 500 Hz steps, follow this procedure:-

From the Tx TEST display press the [Audio Gen] key.

Use the [Gen 1/Gen 2] key to select **AF1**

Press the orange [LEVEL] key.

The **LEVEL** legend following **AF1** will be highlighted.

Press the orange [Δ INC] key, followed by [5] [0] [0] and the [Hz] terminator key.

The display will show the legend

Increments
AF1 FREQ: 500 Hz

Now each press of a FREQ [↑] or [↓] key will increase or decrease the output frequency of AF generator 1 by 500 Hz.

Points to note are:-

Each press of a FREQ [↑] or [↓] key will be effective from the current point. Thus if the frequency of the generator in the above example has been incremented to **1,500 Hz** and *then adjusted* by use of the variable control (or the data entry keys) to **1,495 Hz**, the next incremental step down will produce a frequency of **995 Hz**.

The assignment and value of a incremental setting will be retained, with the mode setup, when a different mode is selected or the Service Monitor is powered down. This is of particular note when assigned to the AF generators as they are also the modulation generators within the Rx TEST mode and the AF generators within the AF TEST mode.

The incremental keys cannot be used when in the Dx TEST mode.

Use within spectrum analyzer mode

The SPEC ANA mode makes use of the FREQ [↑] and [↓] keys for span adjustment. The span is ranged up or down in a 1, 2, 5 sequence, from 1.0 kHz to 1.0 GHz.

Adjustment to the span by these keys is linear about the center frequency and will not adjust below zero or above the top frequency limit.

When the **Centre** legend is highlighted the FREQ [↑] and FREQ [↓] keys will increment the center frequency by the value last set up in the TxTEST mode.

The LEVEL [↑] and [↓] keys adjust the reference level of the spectrum analyzer in either 2 dB or 10 dB steps depending on the setting of the reference level vertical range.

Tones

Tones sub-mode

Audio tones and digital code signals are used for many purposes within radio communication systems. The Service Monitor has a TONES mode accessed from the Tx TEST, Rx TEST, Dx TEST and AF TEST modes.

This gives facilities for testing tone calling and control systems of the following types.

- Sequential Tones. A selective calling system using audio tones.
- CTCSS (Continuous Tone Coded Squelch System).
- DCS (Digitally Coded Squelch).
- DTMF (Dual Tone, Multi-Frequency).
- POCSAG (Post Office Code Standardization Advisory Group). A paging system using digital signaling.

The tone mode is entered from the top level screen of any main mode, other than SYSTEM or SPEC ANA.

Pressing the *[Tones]* key will display the screen shown in Fig. 3-20, *Tones selection screen and Tones mode receiver input level setting*.

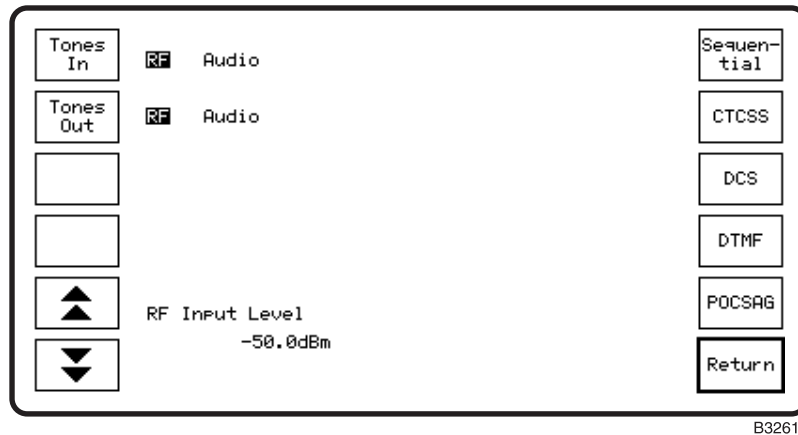

Fig. 3-20 Tones selection screen and Tones mode receiver input level setting

Observing tones signals in other test modes

The effect of any tones signaling on transmitters or receivers under test can be studied using any test mode of the Service Monitor.

When a test mode is selected, (either by pressing the [Tx TEST] key, [Rx TEST] key etc. or by pressing the *[Return]* key), while any tones signal is running continuously (CTCSS or DCS Tones On; Sequential or DTMF continuous mode Sending), the tones will continue to be generated. See the Tones ON/OFF control section of each specific tones description.

Signal routing

The tones sub-mode can be entered from either Tx TEST, Rx TEST, Dx TEST or AF TEST modes.

The encoded signal produced by the Service Monitor can be routed to the equipment under test in two ways:

- As a modulated RF signal from either of the RF output connectors.
- As an AF signal from the AF GEN OUT connector.

Similarly, an encoded signal produced by the equipment under test can be routed to the Service Monitor in two ways:

- As a modulated RF signal to either of the RF input connectors.
- As an AF signal to the AF INPUT connector.

The input and output routing settings are made from the TONES selection screen. Pressing the *[Tones In]* or *[Tones Out]* key alternates the setting between **RF** and **Audio**. The selected settings will be retained until reset, either manually or by recalling Service Monitor settings. Any tone sequence or continuous tone that is running when an input or output routing setting is changed will be stopped.

RF input attenuators

The RF input circuits of the Service Monitor are auto-ranging under most operating conditions. When operating in some of the tones modes this can be a disadvantage as the tones decoders need to receive the leading burst of any transmission. Therefore when 'TONES' mode is selected, the auto-ranging function is disabled and the RF input sensitivity of the service monitor is set manually.

This is done by using the *[▲]* and *[▼]* keys on the TONES selection screen. For correct operation of the TONES decoders, the input signal level should *not exceed* the level set.

Each keypress will switch the sensitivity of the service monitor up or down by 10 dBm. If the level of the applied signal is unknown, it can be measured using the Tx TEST mode. The Service Monitor RF Input Level can then be set *above* the measured level.

The following table shows the RF input level settings that are available for either of the RF input connectors.

RF N in		RF Antenna in		Audio
398 W	56.0 dBm	1.00 W	30.0 dBm	<40.0 V
39.8 W	46.0 dBm	100.0 mW	20.0 dBm	<20.0 V
3.98 W	36.0 dBm	10.0 mW	10.0 dBm	<10.0 V
398 mW	26.0 dBm	1.00 mW	00.0 dBm	<4.0 V
39.8 mW	16.0 dBm	100 μW	-10.0 dBm	<2.0 V
3.98 mW	6.0 dBm	10 μW	-20.0 dBm	<1.0 V
398 μW	-4.0 dBm	1 μW	-30.0 dBm	<400 mV
40 μW	-14.0 dBm		-40.0 dBm	<200 mV
4 μW	-24.0 dBm		-50.0 dBm	<100 mV

When using the AF INPUT connector for TONES operation, the *[▲]* and *[▼]* keys on the TONES selection screen set the AF input sensitivity. The column headed Audio, in the above table, lists the AF input settings. The AF input signal level should be less than that shown for the current setting.

Sequential tones

Overview

Sequential tones signaling systems use sequences of audio tones to control various functions of a radio system. There are many systems in operation world-wide, all using up to 15 tones labeled with the hexadecimal digits 0 to E with 'No Tone' as F. Some systems make use of extended tones for certain functions.

Each version has its own tone allocation tables for the 15 tones and its own timing for tone duration.

The versions for which tone allocation tables and tone duration values are included in the Service Monitor are:-

CCIR	ZVEI	DZVEI	EEA	EIA	USER 1	USER 2
------	------	-------	-----	-----	--------	--------

The USER 1 and USER 2 tables allow tone frequencies and tone durations to be programmed by the user.

This Service Monitor has encoding facilities with variable parameters which allow signals to be produced for testing systems using precise values and adverse values. The decoding facility will measure the frequency and duration of the received tones, match the results against the appropriate look-up table and list the results with the identification of each tone.

Observe notes relating to signal routing and RF input attenuators at beginning of this section. See page 3-71.

Continuous sequential tones can be produced at the same time as CTCSS or DCS tones.

Using the decoder

The sequential tones decoder will function when the Service Monitor is in the Rx TEST mode.

Press the *[Decoder]* key and the AF SEQUENTIAL DECODER screen will be displayed. A tone sequence fed into the AF input will be decoded and the results will be displayed.

Testing sequential tone receivers

Using the encoder

To test the operation of receivers using sequential tone signaling, proceed as follows:-

Rx TEST settings

Select the receiver test mode by pressing the [Rx TEST] key.

Set the RF output frequency of the Service Monitor to that set on the receiver.

Ensure that the RF generator within the Service Monitor is in the OFF condition. This should remain OFF until the Service Monitor and the receiver under test are set up and properly interconnected.

Make a suitable RF connection between one of the Service Monitor RF output connectors and the RF input connector of the receiver.

Set the RF output level from the Service Monitor to an appropriate setting.

Select the 'RF SEQUENTIAL TONES' function by using the key sequence, *[Tones]*, *[Sequential]*. The screen and menu shown in Fig. 3-21, *RF Sequential tones encoder display, main menu*, will be displayed.

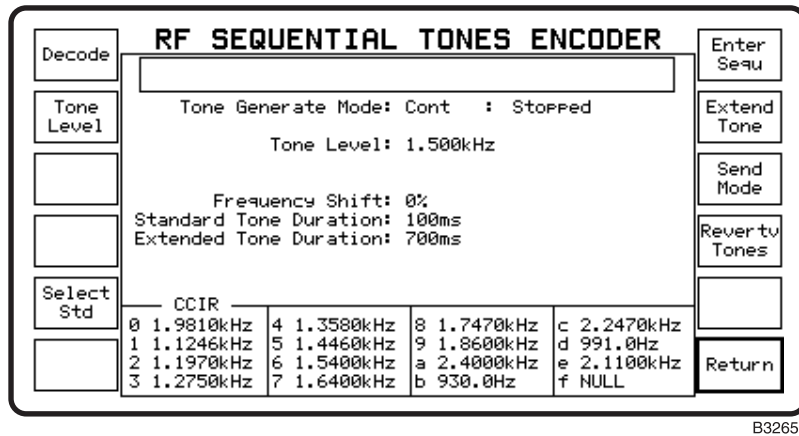

Fig. 3-21 RF Sequential tones encoder display, main menu

Setting the Tones mode

The display is divided into three areas.

- At the bottom of the display is a table listing the frequencies allocated to the 15 tones, 0 to E. Above the table is shown the system type, i.e. CCIR, ZVEI etc.
- At the top of the display is a panel in which the tone sequence to be transmitted is assembled or edited.
- The center of the display shows information relating to the parameters of the system.

Check that the system type shown above the frequency table is the same as the system type on which the receiver to be tested operates. If this is not correct, press the [Select Std] key to display the SELECT TONES STANDARD screen and menu shown in Fig. 3-22, Sequential tones standard selection menu.

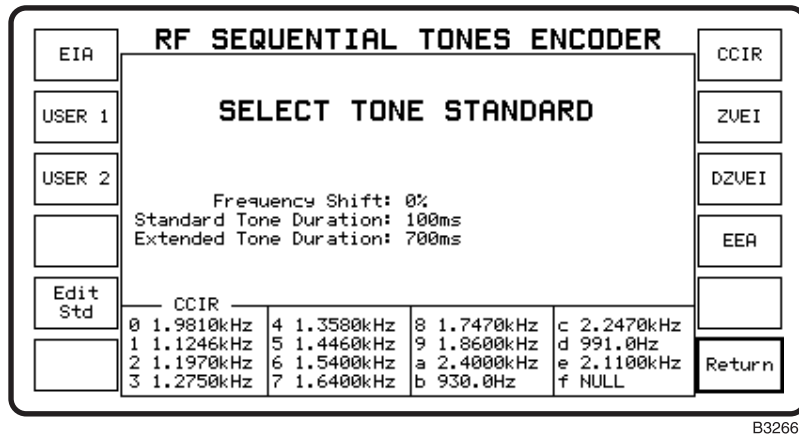

Fig. 3-22 RF Sequential tones standard selection menu

Select the correct system standard by pressing the appropriate key. The frequency allocation table will change to relate to the selected standard and the settings of the tone duration parameters will also change to the correct values for the system.

Return to the main sequential tones menu.

When the frequency allocation table is correct for the system, check that the other parameters are correctly set. The tone modulation level has a default setting of 1.5 kHz but can be set by the user to any level up to the Service Monitor's maximum of 75 kHz.

Creating the tone sequence

To create the required tone sequence, first press the *[Enter Sequ]* key to display the cursor in the tone sequence panel.

Enter the required sequence by using any of the data entry keys 1 to 9, zero and the Hex digits A to E. The *[Extend Tone]* key is used to convert a standard tone to an extended tone or an extended tone to a standard tone. With the cursor positioned over the tone to be changed, each press of the *[Extend Tone]* key will extend it or reduce it to standard. The cursor is moved by using the variable control.

Editing a tone sequence

An existing tone sequence can be edited as required. Using the rotary control, move the cursor over the character to be changed. To delete the unwanted character and insert a new character in its place, press the data key corresponding to the new character. To delete an unwanted character and close up the sequence, press the *[DELETE]* key.

Editing the tone standard

Tone frequency shifting

The frequency of all the tones in the table can be collectively altered by up to $\pm 10\%$ for tolerance checking.

Tone duration

The duration times for standard and extended tones are set to the system standard when the system is selected. They can be altered by the user from the EDIT TONE STANDARD screen, which is accessed by pressing the *[Edit Std]* key on the SELECT TONE STANDARD screen.

Press the *[Tone Durat'n]* key or the *[Tone Ext Dur]* key as appropriate and enter the required duration using the data entry keys and the *[ms]* terminator key.

Producing the sequential tone signal

The Service Monitor has four tone modes for producing sequential tone signals. These are selected after pressing the *[Send Mode]* key. This will display the soft keys shown below:-

[Cont Tones] Generates the tone sequence repeatedly.

[Tone Burst] Generates one sequence of the tones then stops.

[Step Tones] Each initiation causes one tone of the sequence to be generated for the stated duration. Subsequent initiations step to the next tone in the sequence.

[Single Tone] Pressing any data entry key will cause the corresponding tone to be generated for the stated duration.

[Return] Returns to the main Sequential Tones menu.

The selected send mode, i.e. Cont, Burst, Step or Single, will be shown on the display against the legend Tone Generate Mode.

Before sending tones using the RF generator ensure that the RF generator is ON.

Tone ON/OFF control

When the RF SEQUENTIAL ENCODER screen or the AF SEQUENTIAL ENCODER screen is displayed, the sequential tones are turned on or off by the orange [ON/OFF] function key.

If the sequential tones are ON and the Tx TEST, Rx TEST, Dx TEST or AF TEST mode selected, the tones will continue to be generated.

If the tones out routing has been set to give RF tones, this is provided by modulation generator 1. The legend ---Tones --- will be displayed against MOD1 FREQ on the RECEIVER TEST or DUPLEX screens. If **MOD1** is selected, the sequential tones can be controlled by repeated presses of the orange [ON/OFF] function key. If **MOD1 FREQ** is selected, the tones are still controlled by the orange [ON/OFF] function key, but if a frequency is entered using the data keys or if the variable control is adjusted, the tones will cease. They can then be re-started *only* when the RF SEQUENTIAL ENCODER screen or the AF SEQUENTIAL ENCODER screen is displayed.

If the tones out routing has been set to give AF tones, this is provided by audio generator 1. The legend --Tones-- will be displayed against AF1 FREQ on the TRANSMITTER TEST, DUPLEX or AF TEST screens. If **AF1** is selected, the tones can be controlled by repeated presses of the orange [ON/OFF] function key. If **AF1 FREQ** is selected, the tones are still controlled by the [ON/OFF] key, but if a frequency is entered using the data keys or if the variable control is adjusted, the tones will cease. It can then be re-started *only* when the RF SEQUENTIAL ENCODER screen or the AF SEQUENTIAL ENCODER screen is displayed.

Testing sequential tone transmitters

To test the operation of transmitters sending sequential tones calling signals, proceed as follows:-

Select the Tx TEST mode, then make all the required settings and RF connections for conventional transmitter testing. Refer to the Tx TEST section of this manual for the correct procedures. Set the frequency of the Service Monitor input to that of the transmitter output.

Key the transmitter and check that the Service Monitor is obtaining a signal from the transmitter.

Select TONES mode. The attenuators in the receive path of the Service Monitor will be held at their current setting. Press the [Sequential] key. The RF SEQUENTIAL TONES DECODER screen and menu is displayed. See Fig. 3-23, *Sequential tones decoder screen*. If the encoder screen is displayed, press the [Decode] key.

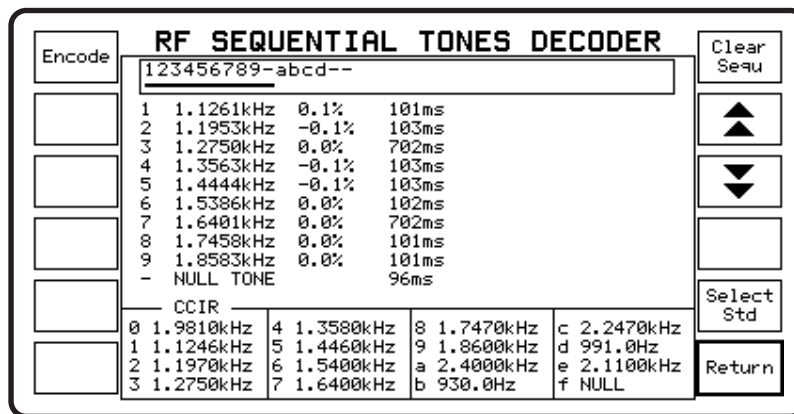

B3268

Fig. 3-23 RF Sequential tones decoder screen

Check that the tones standard shown above the tone number/frequency list corresponds to the system used by the transmitter. If this is not correct, select the correct standard from the menu accessed through the [New Std] key.

Key the transmitter to transmit a tone sequence. Within the Service Monitor the TONES decoder will decode the tones sequence obtained from the modulation meter.

The decoded sequence will appear in the panel at the top of the display, with the first 10 characters underlined. The sequence decoder store can hold up to 40 decoded characters. Any received in excess of this will be lost.

The underlined tones are listed in the center of the display with an analysis of the parameters of each tone as below:-

- The measured frequency of each tone.
- The percentage error from the true tone frequency.
- The duration of each tone.

By using the [▲] or [▼] keys, the analysis of all tones in the decoded sequence can be shown.

The stored sequence can be cleared from the store by pressing the [*Clear Sequ*] key.

Revertive tones

Revertive tones signaling takes various forms. The common factor is that a tone sequence received by a mobile transceiver or other receiver, will trigger a second sequence to be returned.

The second sequence may be a duplicate of the first or a different sequence. It can be used to modulate a signal on a reverse channel or on a different channel. For some applications either or both of the tone sequences may be used as an AF signal.

The routing of the original tone signal out of the Service Monitor, and the revertive tone signal into the Service Monitor, is dependent on the settings of the [*Tones In*] and [*Tones Out*] keys on the TONES selection screen. This allows the permutations shown in the following table.

Original tones out	Revertive tones in
RF	RF
RF	AF
AF	RF
AF	AF

The revertive tones operation is configured by pressing the [*Revertv Tones*] key. To send a tone burst, do one of the following:-

- If TONE BURST has NOT already been selected as the send mode, press the [*Send Mode*] key to access the send mode menu, then press the [*Tone Burst*] key. The tone sequence will be generated, then after the last tone, the Service Monitor will change to decode mode ready to decode the revertive tones.
- If TONE BURST has already been selected as the send mode, press the orange [ON/OFF] function key. The tone sequence will be generated, then after the last tone, the Service Monitor will change to decode mode ready to decode the revertive tones.

The encoder screen can be displayed again by pressing the [*Encode*] key.

CTCSS

The CTCSS tones system uses a continuous tone at a precise frequency, transmitted below the audio pass band, to unscquelch the receiver.

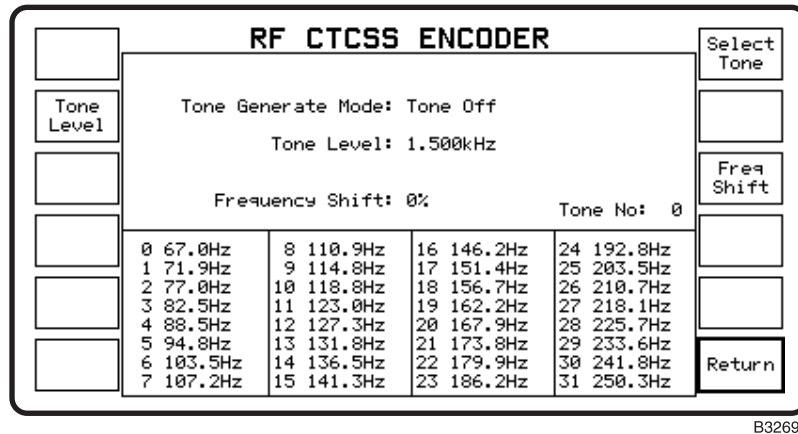

Fig. 3-24 RF CTCSS encoder screen and menu

Pressing the [CTCSS] key on the TONES selection screen will display the screen shown in Fig 3-24, RF CTCSS encoder screen and menu.

The CTCSS function of the Service Monitor will generate a single AF tone, selected from those listed on the display.

Output level

The required output level of the tone signal can be set using the data entry keys, after highlighting the legend **Tone Level** by pressing the [Tone Level] key.

The units used to specify the output level will relate to the selected output routing and, when RF output is selected, the modulation method. The modulation type is automatically set, to be appropriate to the level terminator key used (FM for Hz, kHz or MHz; AM for %).

The valid output range for each output option is shown in the following table.

Output type	Output range	Default
RF AM	0 - 99%	30%
RF FM	0 - 75 kHz	1.5 kHz
Audio	100 μ V - 4 V	100 mV

Tone selection

The required tone is selected from the table in the lower part of the display. Press the [Select Tone] key to highlight the legend **Tone No.** Use the data keys to enter the number of the required tone, then press the [ENTER] key.

Tone frequency shift

The frequency of the selected tone can be shifted by up to $\pm 10\%$. Press the [Freq Shift] key to highlight the legend **Frequency Shift**. Use the data keys to enter the value of frequency shift required. Only whole numbers within the above range are valid. Complete the entry with the [%] key.

Tone ON/OFF control

When the RF CTCSS ENCODER screen or the AF CTCSS ENCODER screen is displayed, the tone is turned on or off by the orange [ON/OFF] function key.

If the CTCSS tone is ON and the Tx TEST, Rx TEST, Dx TEST or AF TEST mode selected, the CTCSS tone will continue to be generated.

If the tones out routing has been set to give RF tones, this is provided by modulation generator 2. The legend --CTCSS-- will be displayed against MOD2 FREQ on the RECEIVER TEST or DUPLEX screens. If MOD2 is selected, the CTCSS tones can be controlled by repeated presses of the orange [ON/OFF] function key. If MOD2 FREQ is selected, the CTCSS tone is still controlled by the [ON/OFF] key, but if a frequency is entered using the data keys or if the variable control is adjusted, the CTCSS tone will cease. It can then be re-started only when the RF CTCSS ENCODER screen or the AF CTCSS ENCODER screen is displayed.

If the tones out routing has been set to give AF tones, this is provided by audio generator 2. The legend --CTCSS-- will be displayed against AF2 FREQ on the TRANSMITTER TEST, DUPLEX or AF TEST screens. If AF2 is selected, the CTCSS tones can be controlled by repeated presses of the orange [ON/OFF] function key. If AF2 FREQ is selected, the CTCSS tone is still controlled by the [ON/OFF] key, but if a frequency is entered using the data keys or if the variable control is adjusted, the CTCSS tone will cease. It can then be re-started only when the RF CTCSS ENCODER screen or the AF CTCSS ENCODER screen is displayed.

DCS

Overview

Digitally Coded Squelch signaling is a system for addressing mobile radio transceivers from their base station by transmitting a code unique to the addressed transceiver for the duration of the transmission. The principles and limitations of the system provide 104 uniquely identifiable codes for use on any one RF channel.

The coded signal consists of a repeating 23 bit word which has error correcting information and timing using 14 bits, leaving nine bits available to carry address code.

The digital signal is formatted as a simple non-return to zero (NRZ) signal which is used to directly modulate the transmitter. On frequency shift modulating systems a '1' is usually made to increase the carrier frequency and a '0' to decrease the carrier frequency. An 'Invert' facility is included to reverse the polarity of the digital signal before it is applied to the modulator.

The most often used bit rate for generating the 23 bit code words and that which is specified in most standards is 134 bits/s. This allows the system to operate below the communications audio pass band.

See *Signal routing* and *RF input attenuators* starting on page 3-71.

DCS receiver decoder testing

To test the DCS decoder function of a mobile transceiver, set up and connect the Service Monitor with the mobile as described in the Rx testing section earlier in this chapter.

Access the DCS facility within the RF tones mode by using the sequence, *[Tones]*, *[DCS]*. The RF DCS Encoder screen and menu is displayed as shown in Fig. 3-25, *RF DCS ENCODER screen and menu*.

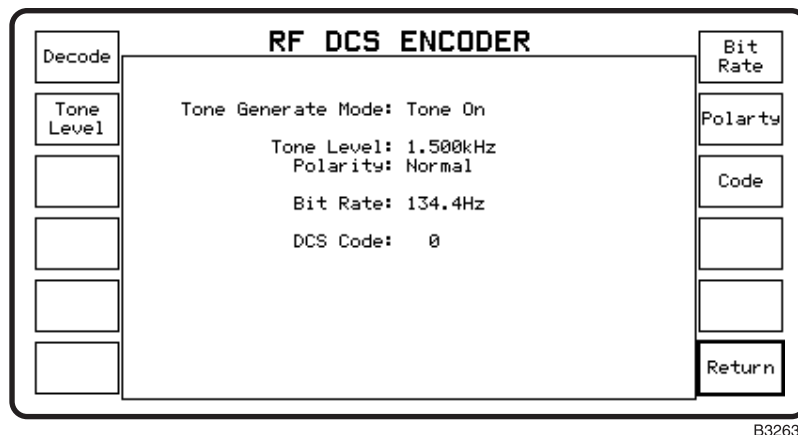

B3263

Fig. 3-25 RF DCS ENCODER screen and menu

Check that the bit rate is correct for the unit to be tested. If a different bit rate is required to that which is shown on the display, enter the required value as follows.

Press the *[Bit Rate]* key to highlight the **Bit Rate** legend on the display. Use the data entry keys to enter the correct value and press the Hz terminator key. *Note. The most common bit rate for DCS systems is 134 bits/s.*

Check that the tone (modulation) level is correct for the system specification. If a different level is required to that which is shown on the display, enter the required value as follows:-

Press the *[Tone Level]* key to highlight the **TO NE LEVE L** legend on the display. Use the data entry keys to enter the correct value and press the [kHz] or [Hz] terminator key as appropriate. *Note. The level of modulation for DCS signal modulation is usually within the range 10% to 20% of the system maximum level.*

Check the modulation polarity of the transceiver. For positive modulation the polarity should be set to Normal and for negative modulation, set to Inverted.

The [*Polarity*] key toggles between these two options.

To enter or change the DCS code for the transceiver to be tested, first press the [*Code*] key to highlight the legend **DCS Code:**. Key in the code using the data entry keys. The Service Monitor will accept any octal sequence in the range 0 to 777.

Complete the entry by pressing the [Enter] key. Leading zeros will be suppressed.

Return to the Rx TEST mode and check that the RF generator is active, then return to the TONES, DCS mode. The DCS coded signal will be produced when the legend Tone On is displayed against Tone Generate Mode:. See *Tone ON/OFF control* below.

Tone ON/OFF control

When the RF DCS ENCODER screen or the AF DCS ENCODER screen is displayed, the tone is turned on or off by the orange [ON/OFF] function key.

If the DCS tone is ON and the Tx TEST, Rx TEST, Dx TEST or AF TEST mode selected, the CTCSS tone will continue to be generated.

If the tones out routing has been set to give RF tones, this is provided by modulation generator 2. The legend --DCS-- will be displayed against MOD2 FREQ on the RECEIVER TEST or DUPLEX screens. If **MOD2** is selected, the DCS tones can be controlled by repeated presses of the orange [ON/OFF] function key. If **MOD2 FREQ** is selected, the DCS tone is still controlled by the [ON/OFF] key, but if a frequency is entered using the data keys or if the variable control is adjusted, the DCS tone will cease. It can then be re-started only when the RF DCS ENCODER screen or the AF DCS ENCODER screen is displayed.

If the tones out routing has been set to give AF tones, this is provided by audio generator 2. The legend --DCS-- will be displayed against AF2 FREQ on the TRANSMITTER TEST, DUPLEX or AF TEST screens. If **AF2** is selected, the DCS tones can be controlled by repeated presses of the orange [ON/OFF] function key. If **AF2 FREQ** is selected, the DCS tone is still controlled by the [ON/OFF] key, but if a frequency is entered using the data keys or if the variable control is adjusted, the DCS tone will cease. It can then be re-started only when the RF DCS ENCODER screen or the AF DCS ENCODER screen is displayed.

DCS transmitter encoder testing

The decoders within transceivers equipped with DCS signaling are usually programmed to generate their code for inclusion on the reverse channel.

The DCS RF decoder function of this Service Monitor is able to demodulate the DCS signal and display the digital data.

The DCS signal is fed into a comparator register and occurrences of bit patterns corresponding to the three 'fixed bits' 0 0 1, of the coded signal are flagged.

23 bit samples of the coded signal are placed in registers with the occurrences of the 0 0 1 sequence occupying the 12, 11 and 10 bit positions. The value of the data in bit positions 1 to 9 is decoded. This corresponds to the DCS code number.

The binary representations of all the decoded sequences are displayed, along with the DCS code. The oct values are compared with the system permitted codes in a look-up table and the true code indicated.

The user can select the decoder bit rate to match that of the system, within the range 100 bits/s to 200 bits/s. The modulation level of the data signal is shown on the display.

DTMF

Overview

Dual Tone, Multi-Frequency.

The DTMF tones function will generate and decode sequences, of up to 40 characters corresponding to the standard DTMF frequencies.

The encoder allows the user to create characters sequences which are routed to the AF GEN OUTPUT connector or to the RF generator modulators.

The decoder will accept up to 40 tone pairs, either from the modulation meter output or as AF signals from the AF INPUT connector.

Tx test DTMF tones function

In the Tx TEST mode, with *[Tones In]* set to , DTMF tones generated within the mobile under test, are recovered from the RF signal and routed to the DTMF decoder.

The RF frequency and modulation type of the transmitter under test is set up from the Tx TEST mode.

Pressing the *[Tones]* key will display the screen shown in fold out diagram (2-5). The *[DTMF]* key will then give access to the RF DTMF DECODER screen shown in Fig. 3-26, *RF DTMF DECODER screen and menu*.

The decoder measures the frequencies and duration of each tone pair, identifies the character, and calculates any frequency errors. The results of this are listed on the display as shown.

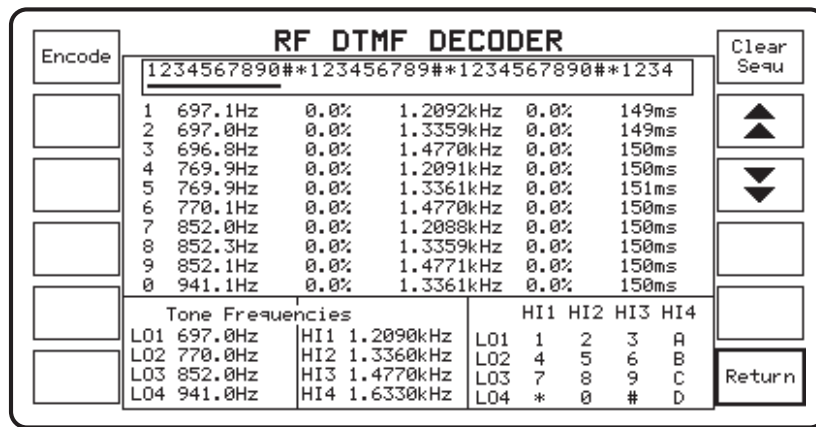

B3118

Fig. 3-26 RF DTMF DECODER screen and menu

The bottom of the screen contains two tables. The tone frequencies table on the left lists the eight frequencies, LO1 to LO4 and HI1 to HI4, used for DTMF signaling. The table on the right shows the 16 digit/character/symbol keypad with the LO tones and HI tones matrix.

The panel at the top of the display area shows the contents of the DTMF decoder memory. A maximum of 40 symbols can be stored, any additional symbols will not be accepted.

The central area of the display, which is blank when first accessed, lists the measured frequencies of ten of the received tones. The underscore in the decoded character panel of the display indicates which characters are listed. The left hand column shows the measured frequencies of the 'LO' tones with the percentage error, the center column the corresponding 'HI' tones with error, while the right hand column shows the duration of each tone.

To display the next 10 decoded results, press the *[▼]* key. To display the previous 10 decoded results, press the *[▲]* key.

The display can be printed and the results stored on a memory card.

To clear the contents of the decoder memory press the *[Clear Sequ]* key. **Once cleared, they cannot be retrieved.**

Rx test DTMF tones function

In the Rx TEST mode, with *[Tones Out]* set to **RF**, the encoder output is fed to the RF generator and the tones used to modulate the RF signal. The DTMF decoder within the receiver under test can then be tested.

When setting up the Service Monitor to test the DTMF decoder of a receiver, commence as for normal Rx tests. When all settings are correct, disable the modulation generators by using the key sequence *[Mod Gen]*, *[Gen 1/Gen 2]*, [OFF/ON], as appropriate, then the RF generator by using the *[RF GEN]*, [LEVEL], [ON/OFF] key sequence.

Press the *[Tones]* key to display the screen shown in fold out diagram (3-5). The *[DTMF]* key will then give access to the RF DTMF ENCODER screen.

Formatting a tone sequence

To create the required tone sequence, first press the *[Enter Sequ]* key to display the cursor in the tone sequence panel. If the tone sequence panel is not empty use the [DELETE] key to clear the sequence.

Enter the required sequence by using any of the 16 available characters of the DTMF keypad. Pressing the equivalent data key on the front panel will cause the character to be entered in the sequence panel. The cursor then moves to the next position and a second character can be entered.

Any number of Null Tones can be included in a tone sequence. A Null Tone is a silent period, and has a duration of one tone period. It is indicated in the tone sequence panel by a dash (—) To enter a Null Tone in a tone sequence, press the *[Null Tone]* key once.

A maximum of 40 characters can be included in a sequence, any further entries will over-write the existing sequence.

Editing a tone sequence

An existing tone sequence can be edited as required. Using the rotary control, move the cursor over the character to be changed. To delete the unwanted character and insert a new character in its place, press the data key corresponding to the new character. To delete an unwanted character and close up the sequence, press the [DELETE] key.

Tones modulation level

The modulation level produced by each tone of the tone pair can be set independently.

Pressing the *[Lo Tone Level]* key will highlight the legend **Lo Tone Level**. The modulation level can then be set using the data entry keys.

The modulation level produced by the tones is set using the *[Lo Tone Level]* or *[Hi tone Level]* key, followed by use of the data input keys. The modulation level limits are 25 Hz to 75 kHz FM or 1% to 99% AM. Attempted entries outside of the values will be ignored. The default level is 1.5 kHz.

The modulation level produced by each tone of the tone pair can be set independently. Levels of the two tones can be locked using the *[Lock Levels]* key. This key toggles between the locked and unlocked condition. When going from unlocked to locked, the latest level set will be taken by both tones.

The tone duration and the pause duration, (time between each tone) can each be set independently, from 20 ms to 1.0 s. The default values are 150 ms duration and 50 ms pause.

A tones frequency shift facility is provided for testing decoder circuits. To shift the frequency of the transmitted tones press the *[Freq Shift]* key to highlight the **Frequency Shift** legend on the display and enter the percentage value of the shift required using the data entry keys. Frequency increases or decreases are possible. Entering a negative value will cause the transmitted frequencies to be decreased from the stated frequency. The maximum frequency shift is 10%.

When the DTMF TONES functions are set, return to the Rx TEST mode and enable the RF generator. Return to the DTMF RF ENCODER function. Press the *[Send Mode]* key to display the Send Mode menu. The options available are:-

[Cont Tones] Generates the tone sequence repeatedly until the orange [ON/OFF] function key is pressed.

[Tone Burst] Generates one sequence of the tones then stops.

[Step Tones] The first press causes the first tone of the sequence to be generated for the duration specified. When the *[Step Tones]* key is pressed again, the next tone in the sequence will be generated for the duration specified.

[Single Tone] After pressing this key, pressing any data entry key will cause the corresponding tone to be generated for the duration specified.

Using the appropriate keys to send the selected tones to the receiver, tests can be made to the DTMF decoder.

Dx test DTMF tones function

When in Dx test mode the DTMF tones function can be accessed by pressing the *[Tones]* key. The user can select encode or decode. The encode function will produce tones for mobile receiver testing and decode will interpret tones produced by a mobile transmitter. The encoder and decoder cannot operate simultaneously.

AF test DTMF tones function

The use of the DTMF tones function within the AF test mode allows the Service Monitor to produce DTMF tones for direct injection into the DTMF decode circuits of mobiles or other equipment.

The decoder will analyze DTMF tones produced within mobiles and other equipment.

The DTMF tones are obtained from the AF output connector on the front panel. The output levels and impedances are as for the AF generator output.

The input to the DTMF decoder within the Service Monitor is through the AF input connector. The decoder will respond to signal levels above approximately 150 mV rms.

Tones ON/OFF control

When the RF DTMF ENCODER screen or the AF DTMF ENCODER screen is displayed, the tone is turned ON or OFF by the orange [ON/OFF] function key.

If the DTMF tone is ON and the Tx TEST, Rx TEST, Dx TEST or AF TEST mode selected, the DTMF tone will continue to be generated.

If the tones out routing has been set to give RF tones, these are provided by modulation generators 1 and 2. The legend --Tones-- will be displayed against both MOD1 FREQ and MOD2 FREQ on the RECEIVER TEST or DUPLEX screens. If **MOD1** or **MOD2** is selected, the DTMF tones can be controlled by repeated presses of the orange [ON/OFF] function key. If **MOD1 FREQ** or **MOD2 FREQ** is selected, the DTMF tones are still controlled by the [ON/OFF] key, but if a frequency is entered using the data keys or if the variable control is adjusted, the DTMF tones will cease. They can then be re-started only when the RF DTMF ENCODER screen or the AF DTMF ENCODER screen is displayed.

If the tones out routing has been set to give AF tones, this is provided by audio generators 1 and 2. The legend --Tones-- will be displayed against both AF1 FREQ and AF2 FREQ on the TRANSMITTER TEST, DUPLEX or AF TEST screens. If **AF1** or **AF2** is selected, the DTMF tones can be controlled by repeated presses of the orange [ON/OFF] function key. If **AF1 FREQ** or **AF2 FREQ** is selected, the DTMF tones are still controlled by the [ON/OFF] key, but if a frequency is entered using the data keys or if the variable control is adjusted, the DTMF tones will cease. They can then be re-started only when the RF DTMF ENCODER screen or the AF DTMF ENCODER screen is displayed.

AF Tone Remote

Overview

The AF Tone Remote system is a remote control facility for controlling remote transceivers of two-way radio systems by sending AF tones over the dedicated fixed voice circuit from the control point to the transmitter. There are two formats in general use.

The Sequential Tone format sends a Guard Tone of (usually) 2.175 kHz and 40 ms, followed by a function tone such as 1.950 kHz, 1.850 kHz or 1.750 kHz and of 40 ms duration, followed by a continuous PTT tone of (usually) 2.175 kHz for the duration of the transmission.

The Single Tone format sends a PTT control tone of (usually) 2.175 kHz to key the transmitter. This continues for the duration of the transmission.

Function tones of usually 350 ms duration and of frequencies such as 1.950 kHz, 1.850 kHz or 1.750 kHz are sent simultaneously to the PTT tone to trigger specific functions such as change the transmitter frequency or mute a receiver.

Testing AF Tone Remote systems

The AF Tones Remote test facility is accessed from the Tones soft key menu of the AF Test mode.

It has a versatile range of tone frequency, level and duration so that it can be used to test most AF Tone Remote systems.

The AF TONES REMOTE screen is shown in Fig. 3-27.

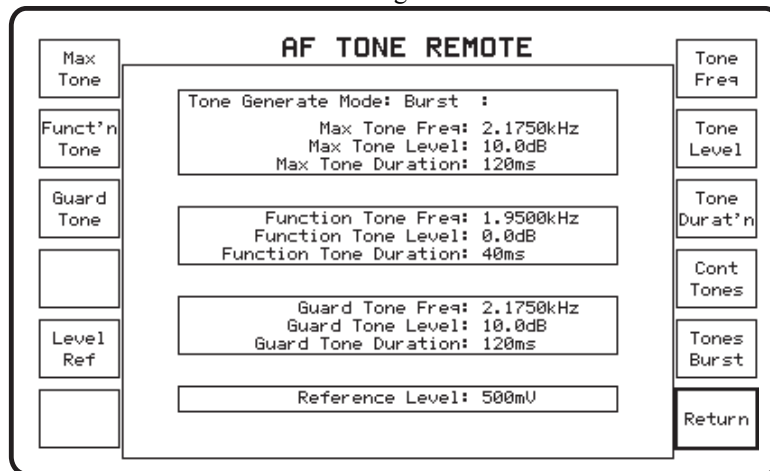

B5895

Fig. 3-27. AF Tone Remote screen

Frequency and Duration setting

Each of the three tone types (Max, Function and Guard) has its parameters set independently. The Frequency parameters can be set to any value within the AF Generator range of the Service Monitor. This is 10 Hz to 30 kHz. The Duration parameter can be set to any value within the Tones output duration of 20 ms to 20s.

The specific Tone Type Frequency and Duration are set by pressing the appropriate Tone Type soft key, then pressing the [Tone Freq] or [Tone Durat'n] soft key. Use the Data Input keys to enter the required value.

POCSAG

Overview

The POCSAG system is an international standard for radio pager operation. The system operates by broadcasting digital messages on a common frequency, only alerting the addressed radio pager when the transmitted address matches that of the pager. The signal transmitted consists of two main elements, the address and the message.

The POCSAG test facility within the Service Monitor generates a paging signal containing all elements of a 'live' signal. This signal is transmitted using the RF generator output to feed a suitable test rig or TEM cell.

The decoder test facility allows a POCSAG type encoded signal to be decoded and displayed.

To access the POCSAG test facility use the following key sequence:-

[Rx TEST], [Tones], [POCSAG].

The screen and menu shown in Fig. 3-28, *POCSAG radio pager test screen and menu*, will be displayed.

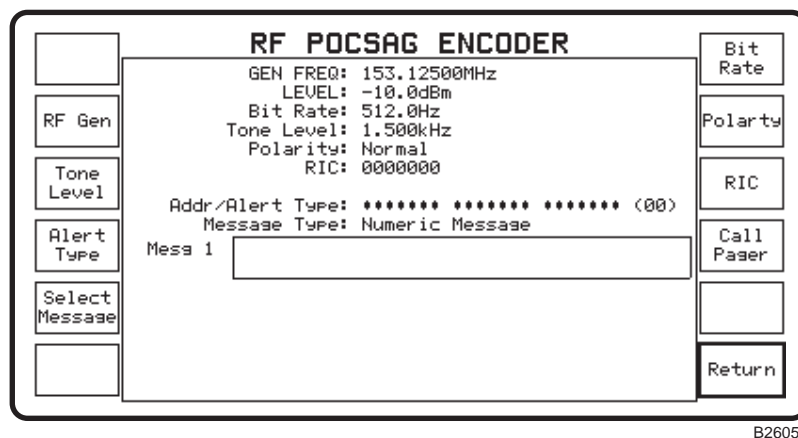

Fig. 3-28 *POCSAG radio pager test screen and menu*

The facilities offered by this Service Monitor for testing radio pagers are:-

- The RF generator of the Service Monitor can be set to any frequency within the specified range of the Service Monitor. The default frequency is 153.125 MHz.
- The RF level can be set to any level within the normal operating level of the Service Monitor.
- The modulation level of the signal can be to any level within the normal operating level of the Service Monitor. The default level is 1.5 kHz.
- The Address and Alert warning type can be set to any of the four available. The alert message generated by radio pagers can be selected from four formats. The selection is controlled by two function bits within the transmitted address codeword. The Service Monitor displays a representation of the audible alert message, shows the relevant function bit combination, and describes the type of message that is transmitted after the particular alert message. See Fig. 3-29, *Alternative address/warning messages*.

The Service Monitor has 7 different inbuilt messages which can be sent to the radio pager. These messages are selected by repeated presses of the [Select Message] key. The selected message is shown in a panel on the display with the legend MESS 1 (or Mess 2 etc.).

The bit rate of the transmitted test signal can be set by the user within the limits 400 Hz to 4.8 kHz. The default bit rate is the standard system bit rate of 512 Hz.

The generated data can be transmitted with normal or inverted polarity.

LOCAL OPERATION

The radio identification code (RIC) of the radio pager is set by the user. This is entered into the Service Monitor as a seven digit decimal number corresponding to the 21 bit address code of the radio pager. The number is unique to the radio pager and will have a maximum decimal equivalent of 2097151.

Note

Leading zero can be omitted from the entry of RIC to save time.

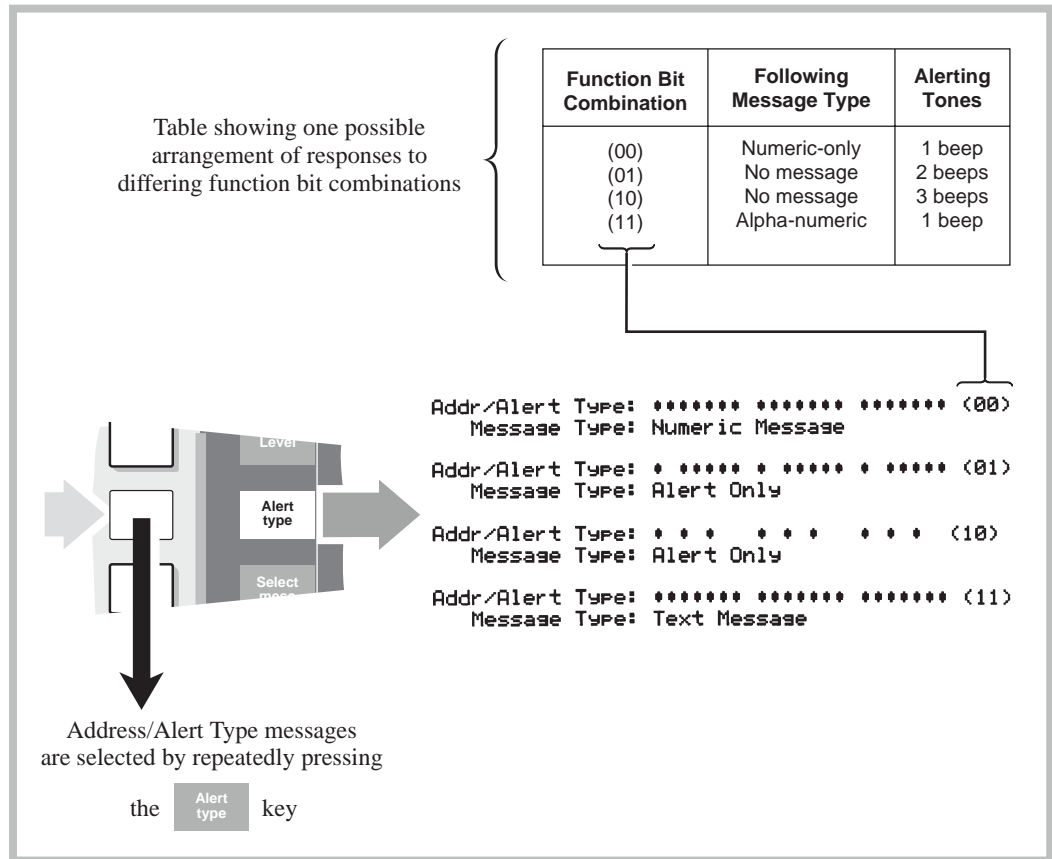

C1883

Fig. 3-29 Alternative address/warning messages

Testing a radio pager

Radio pagers are self-contained units with no external antenna provision, therefore it is not possible to make a direct RF connection between the Service Monitor and the pager. The Service Monitor output can be taken from the BNC RF output connector using the telescopic antenna accessory (Aeroflex part no. 54421/001) or similar, where suitable screening is available. Alternatively, a TEM cell may be preferable.

To configure the Service Monitor to make operational tests to a radio pager proceed as follows:-

- Select the POCSAG option from the Rx TEST mode, TONES function.
- Set the RF generator frequency to match the pager system operating frequency. Press the *[RF Gen]* key to highlight the GEN FREQ: legend on the display. Enter the required frequency using the data input keys.
- Set the RF output level to a suitable value by pressing the *[RF Gen]* key followed by the orange [LEVEL] key to highlight the GEN and LEVEL: legends on the display. Use the data input keys to enter the RF level.
- Set the modulation level to match the specification of the system to which the pager is assigned. Press the *[Tone Level]* key to highlight the **Tone Level:** legend on the display. Enter the required modulation level using the data input keys.
- Set the bit rate to match the specification of the system to which the pager is assigned. Press the *[Bit Rate]* key to highlight the **Bit Rate:** legend on the display. Enter the value of the required bit rate as a frequency using the data input keys, terminated by [Hz].
- If the system requires the transmitted data to have an inverted format, press the *[Invert]* key to make the legend beside the Polarity: legend on the display read Inverted. The *[invert]* key toggles the legend between Inverted and Normal.
- Set the RIC, (Radio Identification Code), to match that of the pager. Press the *[RIC]* key to highlight the legend **RIC** on the display and enter the required number using the data entry keys, followed by [ENTER]. An attempt to enter a number which exceeds the range of the system maximum will not be accepted and the previously displayed **RIC** will be retained.

The Service Monitor is now configured to produce a signal compatible with the radio pager. With the radio pager powered up and located as mentioned above, press the *[Call Pager]* key. The radio pager will respond.

To test the differing response options of the radio pager, the user can select the combination of function bits and the contents of the message transmitted.

The Function bits are changed by repeated presses of the *[Alert/Type]* key. See Fig. 3-28, *POCSAG radio pager test screen and menu*, above.

The message content of the signal can be selected from 7 options by repeated presses of the *[Select Message]* key. Message 1 contains no data and thus produces an alert only response from the radio pager.

The parameters of the test signal can be varied within the limits mentioned in *Facilities* above, to test the performance tolerances of the radio pager.

Decoding POCSAG type signals

The POCSAG DECODE option allows signals containing data formatted to the POCSAG specification to be decoded and displayed.

Decoding of either numeric or alpha-numeric messages is selectable.

The decoder can be set to respond to and display:-

<p>Only messages addressed to a specified RIC number.</p> <p>Only messages containing the sequence 12345.</p> <p>All messages.</p>
--

To configure the Service Monitor to decode POCSAG signals proceed as follows:-

- If the signal is to be obtained by 'Off air' monitoring, select Tx TEST mode or Dx TEST mode and the BNC (antenna) input. Use a suitable antenna to receive the transmissions. Set the transmitter frequency (Tx FREQ), of the Service Monitor receiver, to the frequency of the transmission to be decoded.
- If the signal is obtained from a receiver output, select AF TEST and connect the receiver output to the AF INPUT socket. Select the POCSAG option from within the TONES function. If the POCSAG decode option is not fitted, the POCSAG ENCODE screen and menu will be displayed, and decoding is not possible. If the POCSAG decode option is fitted the POCSAG DECODE screen and menu will be displayed.
- Set the RIC code, if messages to a specific 'RIC address' only are to be decoded (see response option selection, below).
- Select the required decode format. The [*Decode Format*] key toggles the selection between *Numeric* and *Alpha-numeric*.

Response options

Select the required response option. Repeated presses of the [*Decode On*] key will sequence through the options of:-

- *ALL* to respond to, and display, the first incoming POCSAG format message.
- *On RIC* to respond to, and display, the first incoming POCSAG format message which is addressed to the set RIC.
- *On sequence 12345* to respond to, and display, the first incoming POCSAG format message which contains the numeric sequence '12345'.

Press the [*Clear Sequ*] key to remove any data from the decode register and to re-arm the decode function.

The next message received, if it conforms to the set decode format, will be decoded and the message displayed.

The following parameters of the signal are decoded and shown on the display:-

Bit Rate:	The bit rate of the received signal.
Polarity:	Normal or inverted coding.
RIC:	The Radio Identification Code of the addressed pager.
Addr/Alert Type:	Shows the format of the alerting signal.
Message Type:	Numeric or Alpha-numeric.

If a message is included in the transmission, this is shown in the message panel. Messages of up to 120 characters can be shown.

The decoder detects the codewords of messages with errors and applies error correction. The number of error codewords received in the message and the number of corrections made is shown.

Oscilloscope

The digital oscilloscope option is available from within the Tx TEST, Rx TEST and AF TEST modes. There are two display functions:

The standard display with a viewing area of approximately 38 × 70 mm.

The expanded display with a viewing area of approximately 63 × 96 mm.

The oscilloscope display may or may not be shown when the Tx TEST, Rx TEST or AF TEST modes are selected. This is dependent on the last use of the selected test mode, and the selection made using the *[Power Up From]* key on setup page 2.

To access the oscilloscope function from a bar chart display, press the *[scope/bar]* key: the first press will show the standard display, the second press will show the expanded display, the third press will return to the bar chart display.

Setting up

The Y sensitivity and the timebase ranges of the oscilloscope are set from the right hand soft keys. The current settings are shown above the oscilloscope display.

When in Rx TEST and AF TEST modes, the Y (vertical) input is by the AF input connector. The Y sensitivity is switchable in a 1, 2, 5 sequence, from 10 mV/division to 20 V/division. The *[AC/DC]* key selects AC or DC coupling into the oscilloscope.

When in Tx TEST mode, the Y input is taken directly from the modulation meter output. The Y axis is calibrated to display modulation level. FM ranges are from 0.5 kHz/division to 25 kHz/division. AM ranges are 5%/division, 10%/division and 20%/division.

The horizontal timebase has ranges of 100 μs/division to 5 s/division in a 1, 2, 5 sequence.

The soft keys have the following functions, (top to bottom):-

<i>[▲]</i>	Increases Y Sensitivity by one range per key press.
<i>[◆]</i>	Decreases Y Sensitivity by one range per key press.
<i>[▶▶]</i>	Increases Time/Division by one range per key press.
<i>[◀◀]</i>	Decreases Time/Division by one range per key press.
<i>[Scope/Bar]</i>	Steps to Expanded display or Bar chart display
<i>[Return]</i> (Standard)	Returns display and menu to Tx TEST, Rx TEST or AF Test.
<i>[Persistence]</i> (Expanded)	Steps persistence setting through Off, Low Med High Inf.

The vertical position of the oscilloscope trace can be adjusted using the POSITION rotary control.

The horizontal sweep trigger can be set for repetitive or single sweep, set by the scope mode keys (Item 15 on fig 3-1, *Front panel*).

With repetitive mode selected, the trace will free-run, re-triggering on the positive-going edge of the signal, at the end of each sweep. In the absence of a signal the trace will auto-trigger.

With single sweep selected, the first positive going signal will trigger a sweep. The *[SINGLE]* key must be pressed to re-arm the trigger circuit before another sweep can be triggered.

Expanded display

With the expanded display selected, the area of the display available for digital readings is limited. The following table shows the data that can be displayed in each test mode.

Tx Test	Rx Test	AF Test
Tx FREQ OFFSET POWER MOD FREQ FM/AM LEVEL SINAD, S/N, DISTORTION	AUDIO FREQ LEVEL SINAD, S/N, DISTORTION	AUDIO FREQ LEVEL SINAD, S/N, DISTORTION

Persistence

The persistence of the scope trace can be selected to suit the user's requirements. The expanded display has a [*Persistence*] key, which steps through the available persistence settings. The persistence setting is effective on both the expanded and standard oscilloscope displays but can only be set from the expanded display.

The following table shows the available settings and the approximate decay times.

Setting	Decay time (seconds)
Off	0
Low	1
Med	3
High	8
Inf	Infinite

Stores, settings/results

Overview

A section of the non-volatile RAM in the Service Monitor is designated as a user store for Service Monitor settings and results. 'Power Down' and 'Factory Pre-set' settings are also held in this area of memory.

The memory card option extends the 'User store' facility, by providing additional memory and by allowing screen bitmaps, 'SYSTEM' settings, 'SYSTEM' results and 'SYSTEM User Defined' test programs to be stored. A 'Print Store' function allows most types of data stored on memory cards to be printed without being recalled to the Service Monitor display.

The use of memory cards is described later under 'Memory cards'.

There are two routes through which the user memory can be accessed, depending on the action to be performed.

To recall data from memory or to store settings, press the orange [MEM] key. This will display the STORE/RECALL screen and menu.

To store test results or bit-maps of test screens, first press the [DISPLAY HOLD] key. The soft key menu will change to show a [Print] key and a [Store] key. Pressing the store key will display the DISPLAY HOLD STORE screen and menu.

STORE/RECALL

To store settings or to recall data from memory proceed as follows:-

Press the orange [MEM] key. The STORE/RECALL screen and menu is displayed. A message, '*Recall from Store No.*' is shown, flashing in inverse video.

A sub-heading 'INTERNAL STORE' is shown above a list of the store locations, with addresses from 00 to 09. A line of details relating to each store is shown against each address.

Store location 00 is followed by the information;

'P Settings Power Down Store'.

This location holds the settings of the Service Monitor when power was last switched off.

The 'P' shows that the data is protected, it cannot be over-written or deleted.

'Settings' shows that the data is a set of Service Monitor settings.

'Power Down Store' is a title identifying the contents.

Similarly store location 01 contains the factory default settings.

Recalling

To recall the contents of a store location, proceed as follows:-

Press the [Recall] key to display the inverse video message, '*Recall Store No.*' if it is not already displayed.

Key in the two digit address of the location, using the data entry keys.

Recalling Settings

Entering '00' or '01' will recall the settings described above.

When 'Settings' are recalled, the Service Monitor will set to the mode which was current when the settings were saved.

Take care after recalling 'settings', as selections such as RF IN/OUT [SELECT], incremental settings and bar chart ranges are included.

Note

The addressing procedure of all memory functions is similar. The flashing, inverse video message describes the action that will happen when a location address is entered, and requests a two digit store address. The first digit entered appears beside the message, but the second digit of the address implements the action.

Recalling Results

When 'Results' are recalled, the RESULTS SCREEN is displayed. The test results are shown against each of the parameter headings. Results of tests made when in the Dx TEST mode are shown with the RECEIVER TEST results in the top half of the display and the TRANSMITTER TEST results in the bottom half.

Storing

Storing settings

To store settings, make sure that all the parameters, selections, bar chart ranges and other settings, relevant to the intended work, are set as required. Then proceed as follows:-

Press the orange [MEM] key and the STORE/RECALL screen will be displayed. Ignore the flashing inverse video message.

Press the [*Store Setting*] key, which will cause the flashing inverse video message to change to, '*Store Settings To Store No.*'.

Key in the two digit address of the required empty or unprotected location. Any data already contained in the location will be overwritten.

The location address list will show the contents of the location as 'Settings'.

A unique title can be attached to the store location. See 'Titling store locations' later.

DISPLAY HOLD STORE

Storing results

Results obtained using the Tx, Rx, Dx, and AF test modes can be stored. For this, the memory is accessed using the [DISPLAY HOLD] key.

To store test results, make the required test, and when the display shows the results to be stored, proceed as follows:-

Press the [DISPLAY HOLD] key. The current soft key menu will be replaced to show two keys, [*Print*] and [*Store*].

Press the [*Store*] key which will cause the DISPLAY HOLD STORE screen to be displayed, with a flashing inverse video message, '*Store Results To Store No.*'.

Key in the two digit address of the required empty or unprotected location. Any data already contained in the location will be overwritten.

The location address list will show the contents of the location as 'Results'.

A unique title can be attached to the store location. See 'Titling store locations' later.

Other memory functions

Other memory functions can be carried out from either the STORE/RECALL or DISPLAY HOLD STORE screen and menu.

Protecting store contents

The contents of any store location can be protected from being over-written or deleted.

To protect a store location, Proceed as follows:-

Press the [*Protect Store*] key. The inverse video message, '*Protect Store No.*' is displayed.

Key in the two digit address of the location to be protected, using the data entry keys. A 'P' will be shown against the location address in the list.

Any attempt to over-write or delete the contents of the location will cause the message '***ERROR Store protected ***' to be displayed momentarily.

To remove the protection from a location, use the same procedure used to protect the location. The 'P' will be removed from the location address.

Deleting store contents

To delete the contents of an unprotected store location, proceed as follows:-

Press the *[Delete]* key. The inverse video message, 'Delete Store No.' will be displayed.

Key in the two digit address of the location to be deleted, using the data entry keys. The contents will be deleted as soon as the second digit is keyed and the location address list will show the location as 'Empty'.

Once deleted, the contents cannot be retrieved.

Note

Store locations 00 and 01 which contain 'Last Power-down' and 'Factory Preset' settings respectively, cannot have their protection removed or be deleted.

Titling store locations

Store locations can be titled from either the STORE/RECALL screen and menu or the DISPLAY HOLD STORE screen and menu. Titles can be up to 20 characters long, including any spaces.

Press the *[Enter Title]* key. The inverse video message, 'Title Store No.' will be displayed. Key in the address of the store location to be titled. The soft key menu will change to show the following keys:-

[▲], *[▼]*, *[Enter Char]*, *[Title Complet]* and *[Return]*.

A line of letters, digits and symbols is shown at the bottom of the display. An inverse video cursor, which can be controlled using the variable control, highlights a selected character on the line. A similar cursor is shown in the title area of the location address.

The selected Character is entered into the title area of the location address list by pressing the *[Enter Char]* key. Subsequent characters are entered in the same way.

Errors can be corrected by using the *[←]* or *[→]* keys to place the cursor over the incorrect character and then inserting the correct character.

When the title is complete, press the *[Title Complet]* key. The normal STORE/RECALL screen or DISPLAY HOLD STORE screen will be displayed.

A title can be changed or corrected at any time using the titling procedure.

Memory card

The optional memory card facility extends the scope of the memory facility by the use of a 'Smart Card' containing non-volatile static RAM with battery back-up. The card should have at least 128 k of memory.

Information loaded onto a card is not unique to the source Service Monitor. The data on memory cards can be read onto other equipment using a suitable card reader.

A memory card is loaded into the memory card port located on the front panel of the Service Monitor. Slide the card, face upwards, into the slot, guided by the channeling on the card and in the slot sides. Firm but not excessive pressure is required over the final 1-2 mm of travel to engage the contacts. The memory card may be inserted or removed from the Service Monitor with the power on or off.

Formatting memory cards

Memory cards must be correctly formatted before data can be stored on them. The MEMORY CARD FORMAT screen and menu has facilities for formatting and checking them.

If a memory card is inserted in the Service Monitor that has been formatted to the required standard, the MEMORY CARD FORMAT screen will show the size of the memory and the title, if any, of the card.

If a memory card is inserted that has not been formatted to the required standard, the message '*Card Not Formatted*' is displayed on the MEMORY CARD FORMAT screen.

To apply formatting, press the [*Format Card*] key. The message '*Writing To Mem Card. Do Not Remove.*' is displayed until the formatting is completed. When the card has been successfully formatted, the memory size will be displayed and the card title will show '*IFR Card*'

Titling cards

To change the card title press the [*Enter Title*] key. A title can then be applied to the card using the same procedure as for titling store locations (see 'Other memory functions, titling store locations') earlier. A card title can have up to 11 characters, including any spaces.

Accessing the memory cards

When a memory card is in place, accessing the user store memory will also give access to the card memory.

The STORE/RECALL screen or the DISPLAY AND HOLD/STORE screen are displayed as described above.

By pressing the [*▼*] key the memory store address list heading changes to 'MEMORY CARD' and a format description. The locations are numbered 10 to 19. Successive operations of this key will increment the numbering by 10 until the list is numbered from 90 to 99. Further operation of the key will have no effect. To return to the lower numbered locations use the [*▲*] key to increment down.

Each memory card has capacity for 90 store locations. Therefore, with a memory card in place, the number of store locations accessible through the STORE/RECALL screen or the DISPLAY AND HOLD/STORE screen is increased to 100; locations 00 to 09 in the normal internal memory, with locations 10 to 99 on the memory card.

Data is stored on the memory cards in files, using a DOS style format. These files can use as much empty card space as they require. Therefore, if large files are stored, such as SYSTEM User Defined test programs, the number of store locations available on that card may be reduced.

All operations relating to internal user stores apply to memory card operation, but with the additional facilities for storing the following:-

Bitmaps of test screens.

Parameter settings for system tests.

Results of system tests.

User defined test programs written in MI-BASIC.

Write-protecting cards

The contents of memory cards can be protected from accidental overwriting or erasure by using the differing methods of protection available on the Service Monitor and the memory cards.

Write protect card switch

Setting the write-protect switch, on the non-contact end of the memory card, offers a physical method of protecting the card contents.

Protect store function

The use of the *[Protect Store]* key described under 'other memory functions' earlier, can be used to protect any selected store location on the card. The protection information is contained on the card and will remain active if the memory card is loaded in other service monitors or equipment.

Lock stores function

A coded lock function, accessible by using the [HELP/SETUP] *[Card Setup]* key sequence, allows a portion of the store locations to be protected behind a four figure code. The use of this function is described below.

Coded store protection

Memory cards can have code protected locking applied to a portion of the store locations. This locking prevents the state of write-protection from being changed.

This allows users not in possession of the code, to have access to data held in protected stores, without being able to remove the protection. Only users in possession of the code can unlock the protection and change the contents.

The same code is needed to adjust the portion of memory locations locked.

After formatting, the code number of a card is 0 (single zero).

Locking Stores

The portion of store locations which can have their protection locked is variable from 1 to 90 locations.

Locking is carried out from the MEMORY CARD FORMAT screen. The right-hand soft keys of this screen include *[Change Code]* and *[Lock Stores]* keys.

Any consecutive number of locations can be locked but must start at location 10.

To lock the protection on a portion of the store locations, proceed as follows:-

Store the settings or results into the required locations of the memory card as described earlier.

Protect the store locations, using the *[Protect Store]* key and the relevant address.

Access the MEMORY CARD FORMAT screen, by the key sequence [HELP/SETUP], *[Card Setup]*.

The legend 'Locked' is shown against the *[Change Code]* and *[Lock Stores]* keys.

Press either of these keys and the inverse video message 'Enter Code' will be displayed.

Newly formatted cards have a code of 0 (single zero). Key this in and press the [ENTER] key. The 'Locked' legend will no longer be displayed.

If the code is not '0', key in the correct four figure code and press the [ENTER] key.

When the 'Locked' legend is no longer displayed, press the *[Lock Stores]* key. The inverse video legend *Lock Stores 10 to* is displayed.

Key in the address of the last store of the portion to be locked, using the data keys. The address will appear on the display as it is keyed in. Press the [ENTER] key.

It will not be possible to change the state of protection of store locations in the locked portion of the memory card. The unprotected store locations can be written to or deleted.

Unlocking stores

Insert the card in the Service Monitor and access the MEMORY CARD FORMAT screen as described above. The legend 'Locked' will be shown against the *[Change Code]* and *[Lock Stores]* keys.

Press the *[Lock Stores]* key, which will cause the message *Enter Code* to be displayed. Key in the four figure code number and press the [ENTER] key. If the correct code number has been entered the 'Locked' legend will no longer be displayed.

The inverse video legend *Lock Stores 10 to 'n'* is displayed ('n' being the number of the highest store location protected).

Key in any store location address lower than 10 and press the [ENTER] key.

Changing the range locking

To change the range of the locked portion, proceed as above but key in the address of the last location of the new portion to be protected and press the [ENTER] key.

Changing the locking code

To change the locking code, use the following procedure:-

Insert the card and access the MEMORY CARD FORMAT screen.

Press the *[Change Code]* key, which will cause the message *Enter Code* to be displayed.

Key in the existing code number and press the [ENTER] key. The 'locked' and the *ENTER CODE* legends will no longer be shown.

Press the *[Change Code]* key. The inverse video legend 'New Card Code' is displayed. Key in a new four figure number and press the [ENTER] key.

The new code will apply to the card but it will not be protected in the Service Monitor until the next power-up.

Storing on memory cards

Storing screen bitmaps

The facility to store a screen bitmap allows any active test screen to be held and saved. This includes oscilloscope traces, spectrum analyzer displays and harmonic analysis displays.

Screen bitmaps are stored from the DISPLAY HOLD STORE screen.

To store a screen proceed as follows:-

Press the [DISPLAY HOLD] key, as described under 'DISPLAY HOLD STORE, Storing results', above, until the DISPLAY HOLD STORE screen is shown.

Press the *[Store Screen]* key. The inverse video message, 'Store Screen To Store No.' is displayed.

Key in the required two digit address.

The location address list will show the contents of the location as 'Screen'.

Storing systems data

Settings and results of SYSTEM tests, and user defined test programs, can only be stored on a memory card when the Service Monitor is operating in a system option. The procedures are described in the operating manual supplement applicable to the system. A summary of operation is:

A memory card location which contains SYSTEM data will show 'Syst Set' or 'Syst Res' or 'BASIC' on the location address list.

To store 'SYSTEMS' data, press the *[MEM]* key. The STORE/RECALL screen will be displayed. A *[Store Sys Par]* key is shown, in addition to those on the non-system screen.

Pressing this key will show a new soft key menu with the three keys *[Store Sys Set]*, *[Store sys Res]* and *[Store BASIC]*. Pressing the appropriate key will store the current system parameter settings, the last test results from the current system or the user defined test program if one is present.

Titling, protecting or deleting can be used as for non-system operation.

Storing system MI-BASIC programs

User defined SYSTEM test programs, which are written in MI-BASIC, can be stored on memory cards as explained above. These must be down-loaded into the Service Monitor before they can be transferred onto a memory card.

Printing from memory cards

The contents of memory card store locations, with the exception of SYSTEM test results, can be sent directly to a printer, without recalling into the Service Monitor display.

To print the contents of a store location, proceed as follows:-

Make sure that a suitable printer is connected, and that the Service Monitor is correctly set up to drive it (see *Printer* on page 3-100).

Access the STORE/RECALL screen.

Press the [*Print Store*] key. The flashing inverse video message, '*Print Store No.*' will be displayed.

Key in the two digit address of the store location to be printed.

The contents of the store will be printed.

When the printout is complete, the Service Monitor can be configured for further tests or operations.

Error messages

There are a number of error messages associated with the store facility, which will be displayed, for approximately 10 seconds, under certain conditions. These are listed below.

- *** ERROR Store Empty **** The recalled store location is empty.
- *** ERROR Card Not Formatted **** The card in the memory card slot is not formatted or the Service Monitor does not recognize the format.
- *** ERROR Store Protected **** The store addressed is protected and therefore cannot be overwritten or deleted. Alternatively, the write protection switch on the memory card is set ON.
- *** ERROR No Card Present **** There is no memory card present, therefore the intended operation cannot be carried out.
- *** ERROR No Card Interface **** An attempt has been made to access a card store when the option is not fitted.
- *** ERROR Card Directory Full **** The internal directory on the card is full, other stores have been put on in a DOS environment (PC).
- *** ERROR Memory Card Full **** The memory card does not have sufficient space to store the intended data.
- *** ERROR Can't Store Internally **** The intended data can only be stored on a memory card.
- *** ERROR DOS File not Found **** The DOS file for the store has been deleted or corrupted on a PC, but the Service Monitor directory file believes it is still there.
- *** ERROR Cannot Print Store **** The contents of the store cannot be printed. Either the addressed store location is an internal store or the location contains SYSTEM settings.

There are also a number of error messages associated with formatting and using memory cards. These are displayed permanently until the condition is remedied or the intended action cancelled.

- No Card Present* An action has been called up which requires a memory card but there is not one present.
- Card Not formatted* The card fitted is not formatted to the requirements of the Service Monitor.
- Option Not Fitted* An action has been called up which requires a memory card but the memory card option is not fitted.
- Unknown Size* The fitted card is not of a recognized memory size.

Real time clock.

Date and time stamping

Purpose

The memory card option also contains a real time clock, with date and time stamping facilities.

The date and time is printed on all screen dump printouts.

Data stored on memory cards also has date and time fields. This information is not visible on the Service Monitor, but is included so as to be visible when memory card files are viewed on a DOS style file display.

A clock set locking facility protects the clock setting from unauthorized adjustment.

Access

The real time clock read-out with its setting facility, is on the MEMORY CARD FORMAT screen and menu. This is accessed by the key sequence, [HELP/SETUP], [*Card Setup*].

Setting the clock date and time

The soft keys on the left of the screen are all relevant to the real time clock.

A new date or time can only be set if the clock set locking facility shows '*Enabled*'. If it shows '*Locked*' the clock four figure access code must be entered. See 'Locking and enabling', below.

To set a new time, proceed as follows:-

Press the [*Set Time*] key once. The 'hours' digits of the digital read-out will be highlighted.

Press the [*▲*] key or the [*▼*] key repeatedly, until the correct hours setting is shown.

Press the [*Set Time*] key again. The 'minutes' digits of the digital read-out will be highlighted.

Press the [*▲*] key or the [*▼*] key repeatedly, until the correct minutes setting is shown.

Press the [*Set Time*] key again. The time display will return to normal and the new time will be set.

To set a new time, proceed as for time setting except for:-

Press the [*Set Date*] key once, to highlight the 'day' digits.

After setting the 'days', 'month' and 'year', press the [*Set Date*] key again to set the new date.

Locking and enabling clock setting

When shipped, the clock set locking code is '0' (single zero). This code ensures that the clock set locking is '*Enabled*'. Any other code will re-lock the clock setting whenever the Service Monitor is powered up.

To lock the real time clock proceed as follows:-

Press the [*Clock Setting*] key. The inverse video legend '*New Clock Code*' will replace the '*Enabled*' legend, with the current code shown beneath it.

If the code shown is '0', key in a four figure code and press the [ENTER] key. The new code will be shown.

The clock setting will remain enabled until the Service Monitor is switched off. The code will be required to enable the clock setting function after the next power up.

If the code shown beneath the '*New Clock Code*' legend is not '0', the clock setting will lock when the Service Monitor is next switched off. The code will be required to enable the clock setting function after the next power up.

Printer

An RS232 printer can be driven by the Service Monitor when connected to the SERIAL PORT on the rear panel. Complete screen images and hard copy of stored test results can be printed.

The serial port must be set to the printer option through 'Setup Page 2' and the *[Remote Control]* key. The port must be configured to match the requirements of the printer, using the port configuration menu, also accessible through 'setup page 2', and the *[serial port]* key.

To print screen images, make the required test, and when the display shows the data to be printed, proceed as follows:-

Press the [DISPLAY HOLD] key. The current soft key menu will be replaced to show two keys, *[Print]* and *[Store]*.

Press the *[Print]* key. The display will be reproduced by the printer.

Test results held in the Service Monitor memory stores or on memory cards can also be printed. The procedures for these operations are described earlier in this chapter. See *Stores, settings/results*, on page 3-91 and *Printing from memory cards*, on page 3-97.

Parallel printer port option

Parallel output

The parallel printer port option provides an output suitable for direct connection to a parallel drive printer. Fig. 3-30, *Parallel printer port socket contacts*, shows the pin numbering of the socket and Table 3-1, *Parallel printer port connections*, shows the function of the socket connections.

Pin connections

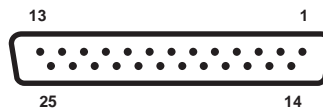

Fig. 3-30 *Parallel printer port socket contacts (as seen facing panel)*

Table 3-1 Parallel printer port connections

Contact	Function	Contact	Function
1	Strobe	10	ACK
2	Data 0	11	BUSY
3	Data 1	12	PE
4	Data 2	13	SLCT
5	Data 3	14	to +5 V via R
6	Data 4	15	ERROR
7	Data 5	16	to +5 V via R
8	Data 6	17	to 0 V via R
9	Data 7	18 to 25	Ground

Accessory port (rear optional)

As well as the parallel printer output, this option also provides an accessory port which allows the control of external devices by logic control from the Service Monitor. Fig. 3-32, *Rear accessory port socket connections*, shows the pin numbering of the socket and Table 3-2, *Rear accessory port connections*, shows the function of the socket connections. Fig. 3-31, *Simplified diagram of rear accessory port switching* shows the switching associated with the port.

Switches 1(a) to 1(d) are parts of a multi-pole rocker switch, mounted on the printed circuit board within the option assembly. By setting these switches, the user has the option of logic level output on the appropriate pins or of closing contacts between pairs of pins.

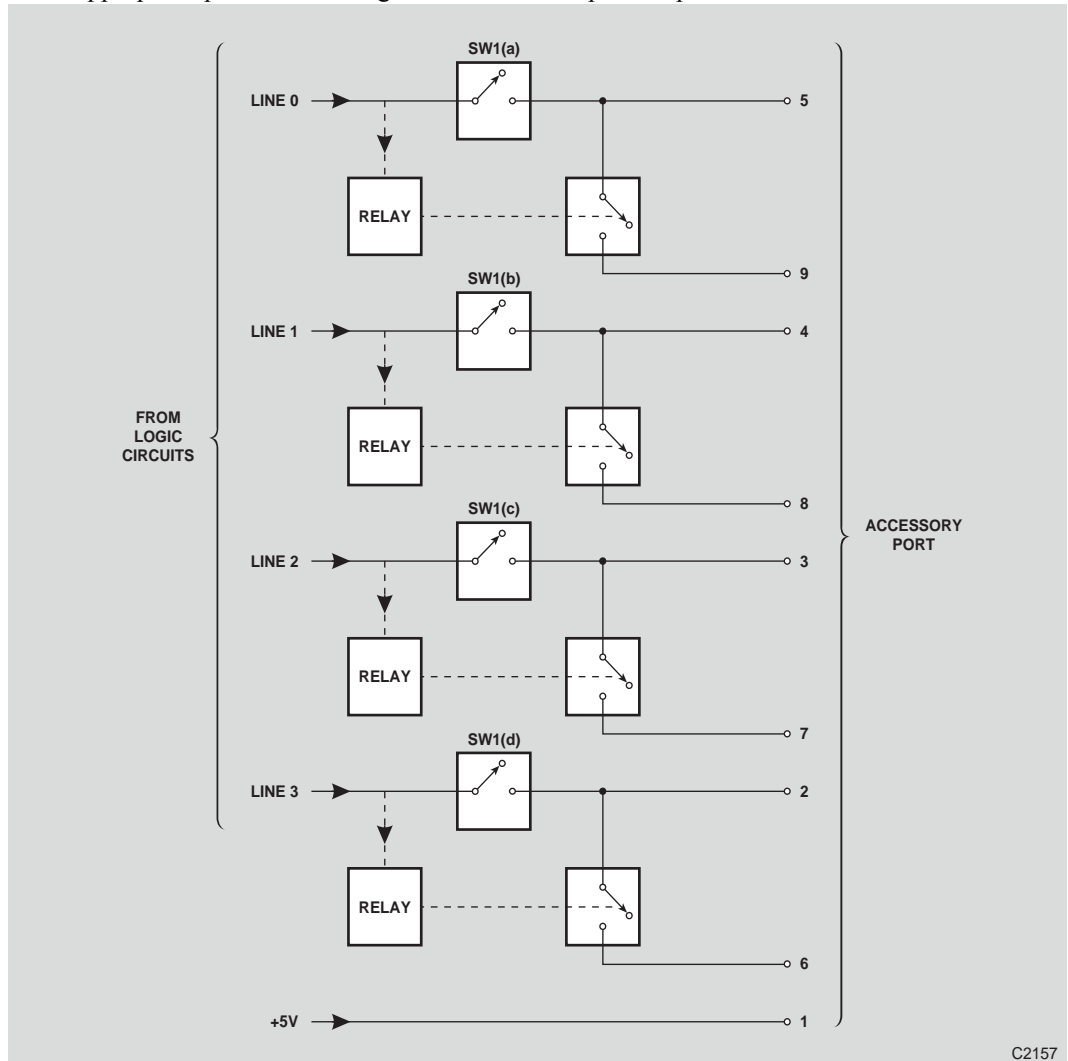

Fig. 3-31 Simplified diagram of rear accessory port switching

Pin Connections

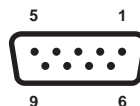

Fig. 3-32 Rear accessory port socket connections (as seen facing panel)

Table 3-2 Rear accessory port connections

Contact	Function
1	+5 V
2	Logic line 3 or logic contact 3(a)
3	Logic line 2 or logic contact 2(a)
4	Logic line 1 or logic contact 1(a)
5	Logic line 0 or logic contact 0(a)
6	logic contact 3(b)
7	Logic contact 2(b)
8	Logic contact 1(b)
9	Logic contact 0(b)

Setting up

Logic line state

The state of the logic lines outputs can be set from the logic lines setup menu, accessible by the key sequence, [HELP/SETUP], [Setup], [Setup Page 2], [Logic Lines].

The top four soft keys on the right of the display control the normal state of the logic lines. Pressing these keys will set the options alternately.

If the appropriate section of S1 is closed, the output can be set to either logic high or logic low. If the appropriate section of S1 is open, the contacts between pin pairs can be set to opened or closed. Switch S1 is mounted within the option assembly, on the printed circuit board. The option assembly must be removed from the service monitor to have access to S1. Remove the power connection from the service monitor, and any connections from the option assembly before removing it from the service monitor. After making changes to S1, refit the option assembly to the service monitor before re-connecting the power lead. Each of the four lines can be set individually.

When any section of S1 is closed, and the connector output of that line (pins 2,3,4 or 5) is at a logic state high, the associated pin (6,7,8 or 9) will also be at logic state high.

When any section of S1 is open, and the connector output of that line (pins 2,3,4 or 5) is at a logic state low, the associated pin (6,7,8 or 9) will be open circuit.

Logic line control

Additional control is provided to logic lines 0 and 1, from the two top soft keys on the left of the logic line setup menu.

When set to 'As setting', the output will be as set by the right-hand soft keys.

When the 'Line 0 Mode' is set to 'Close for Transmit', the state of this line will depend upon which operating mode the Service Monitor is set to.

When the Service Monitor is in the Rx TEST mode, line 0 will take up the 'Closed/Logic High' state, and the 'Open/Logic Low' state for all other test modes.

The 'Press To Talk' switch on the accessory microphone, if this accessory is fitted, will switch the Service Monitor from Rx TEST mode to Tx TEST mode. Therefore line 0 will also change state when the 'Press To Talk' switch is operated.

When the 'Line 1 Mode' is set to 'Close on Squelch', line 1 will take up the 'Closed/Logic High' state when the Service Monitor is in a squelched condition, and the 'Open/Logic Low' state when the instrument is not squelched.

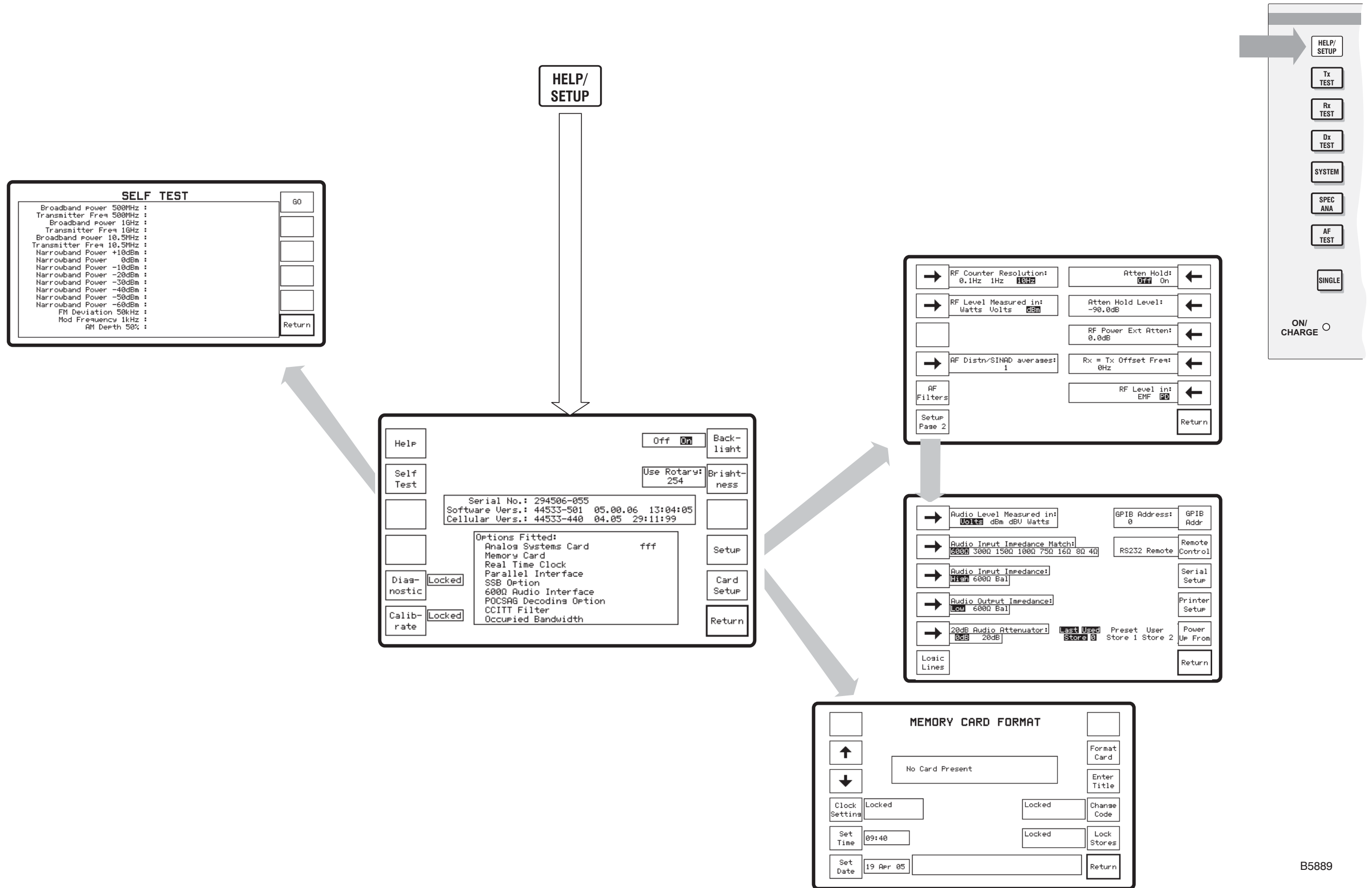

Test mode screen and menu (1.0). HELP/SETUP with next levels.

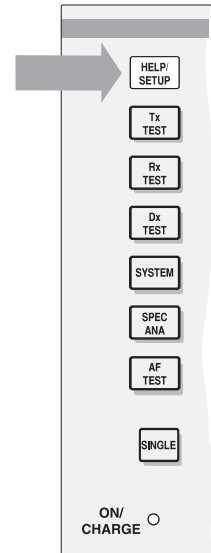

C4176

Fold out diagram number (1.0)

LOCAL OPERATION

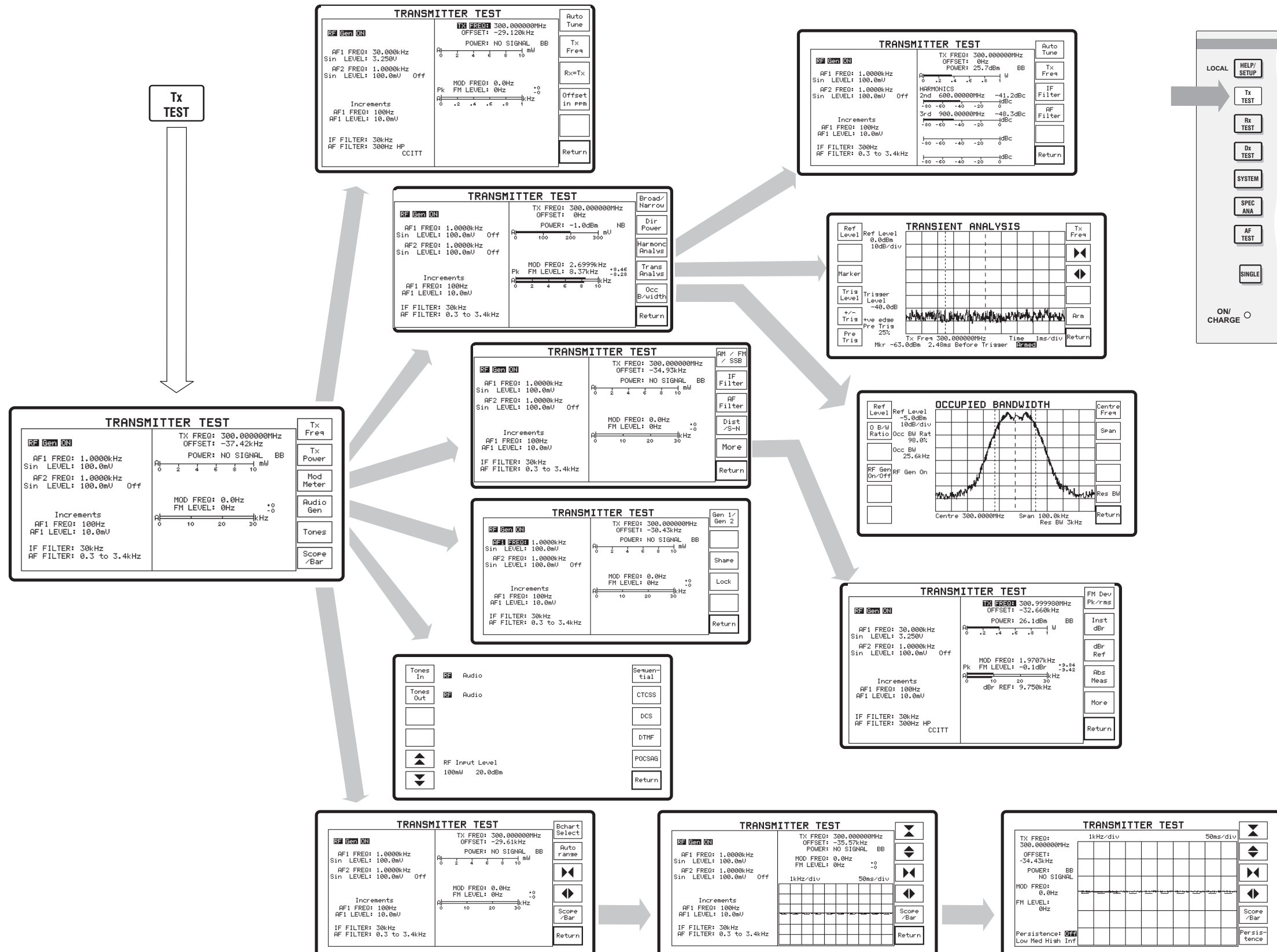

Test mode screen and menu (2.0). Tx TEST with next levels.

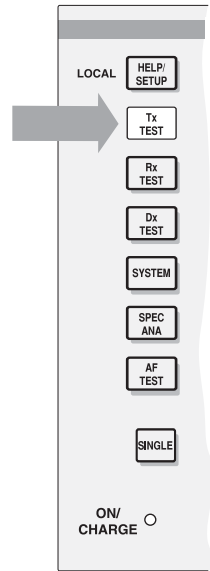

C4178

Fold out diagram number (2.0)

LOCAL OPERATION

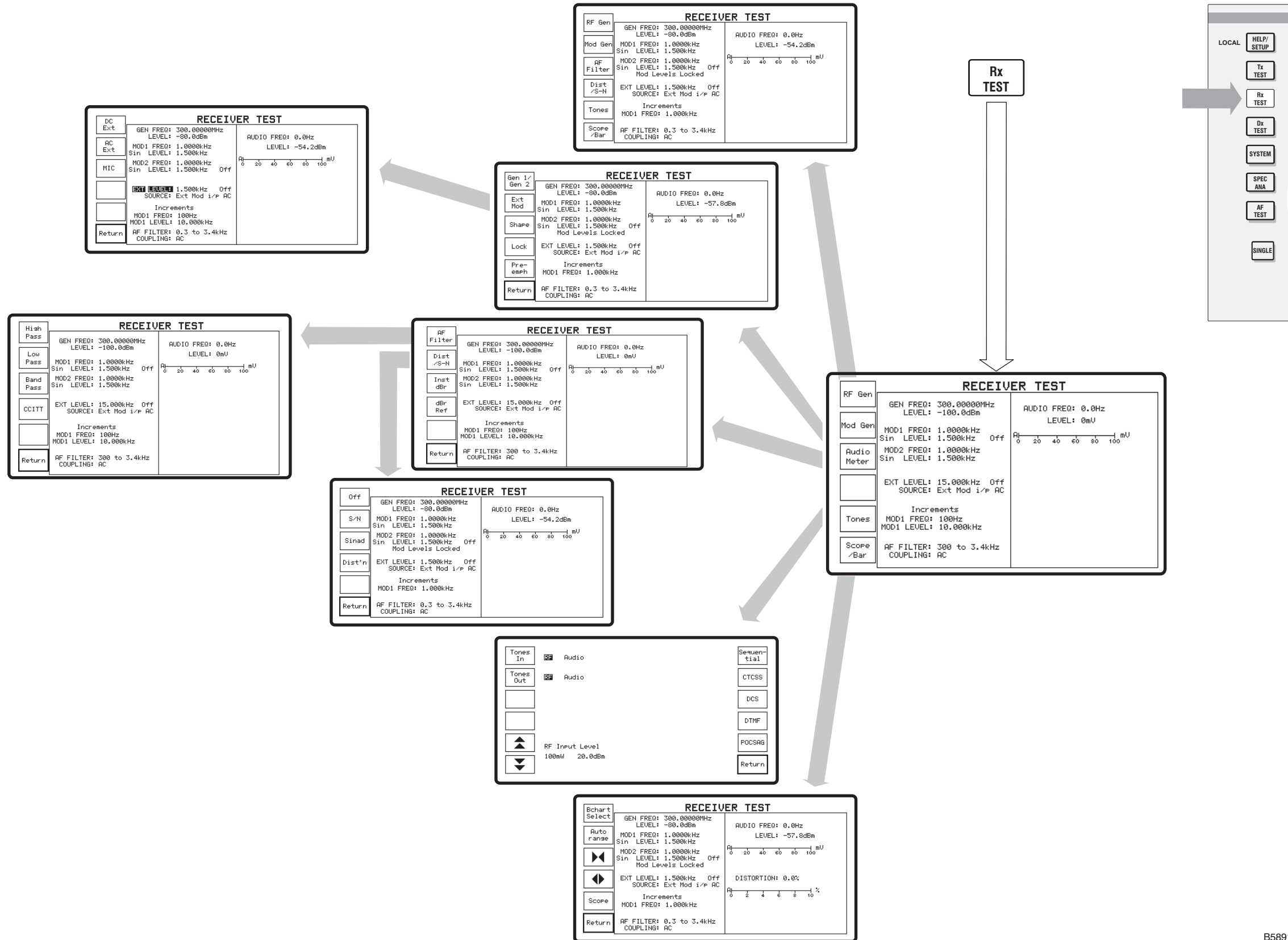

Test mode screen and menu (3.0). Rx TEST with next levels.

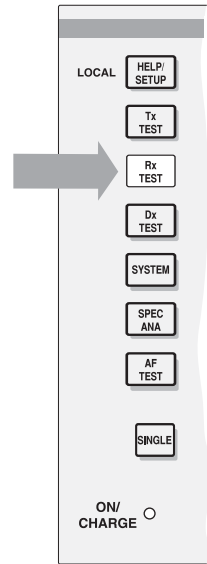

C4180

Fold out diagram number (3.0)

LOCAL OPERATION

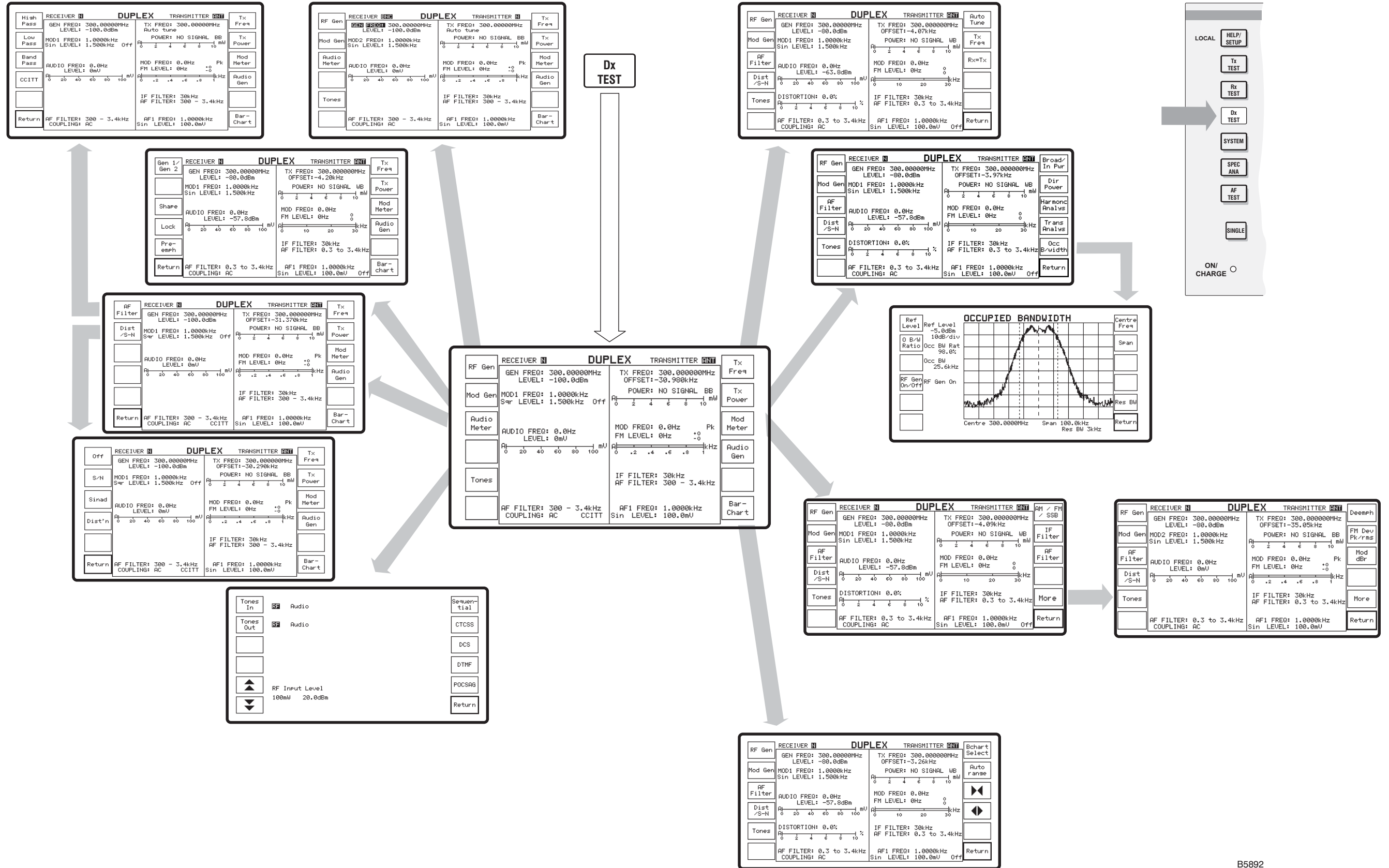

Test mode screen and menu (4.0). Dx TEST with next levels.

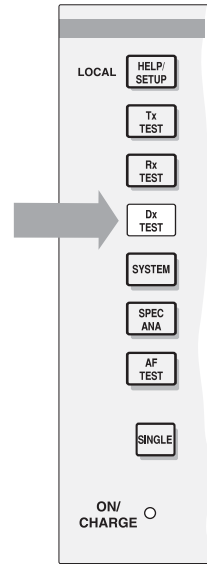

C4182

Fold out diagram number (4.0)

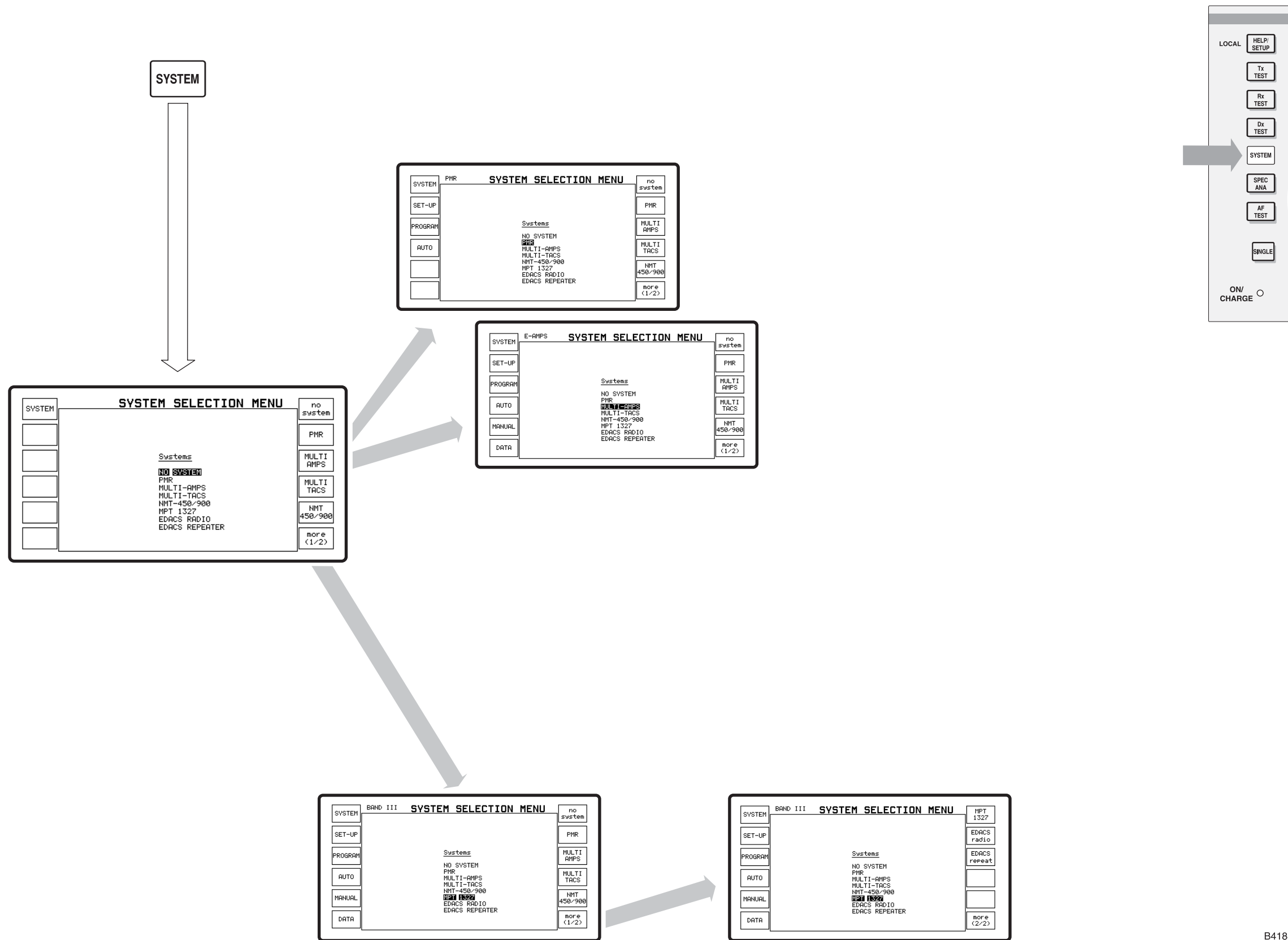

Test mode screen and menu (5.0). SYSTEMS with next levels.

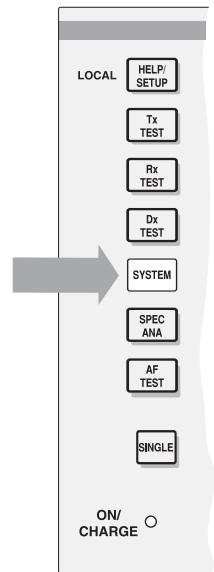

B4184

Fold out diagram number (5.0)

LOCAL OPERATION

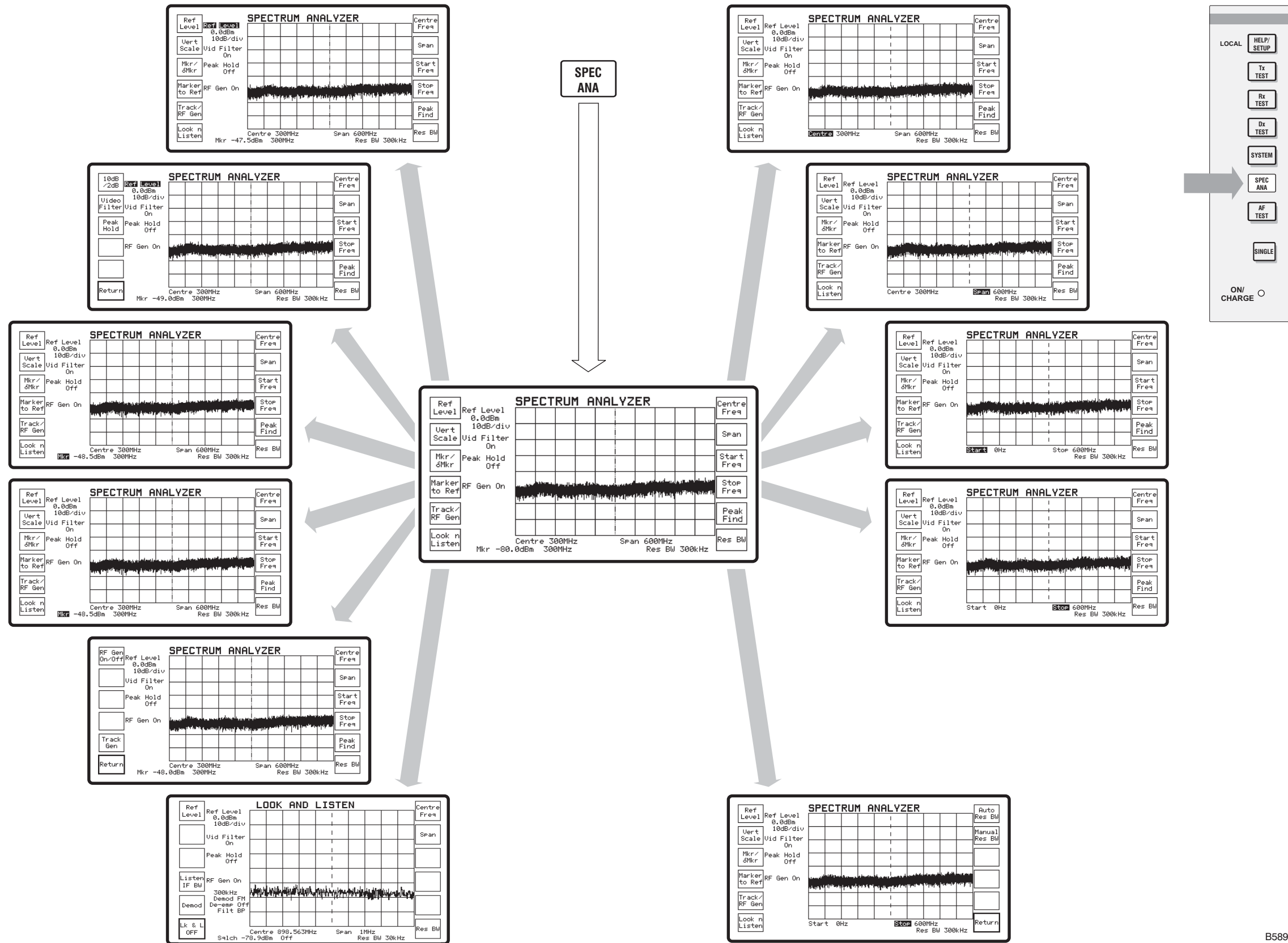

Test mode screen and menu (6.0). SPEC ANA with next levels.

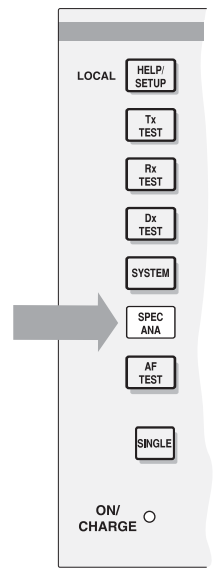

C4186

Fold out diagram number (6.0)

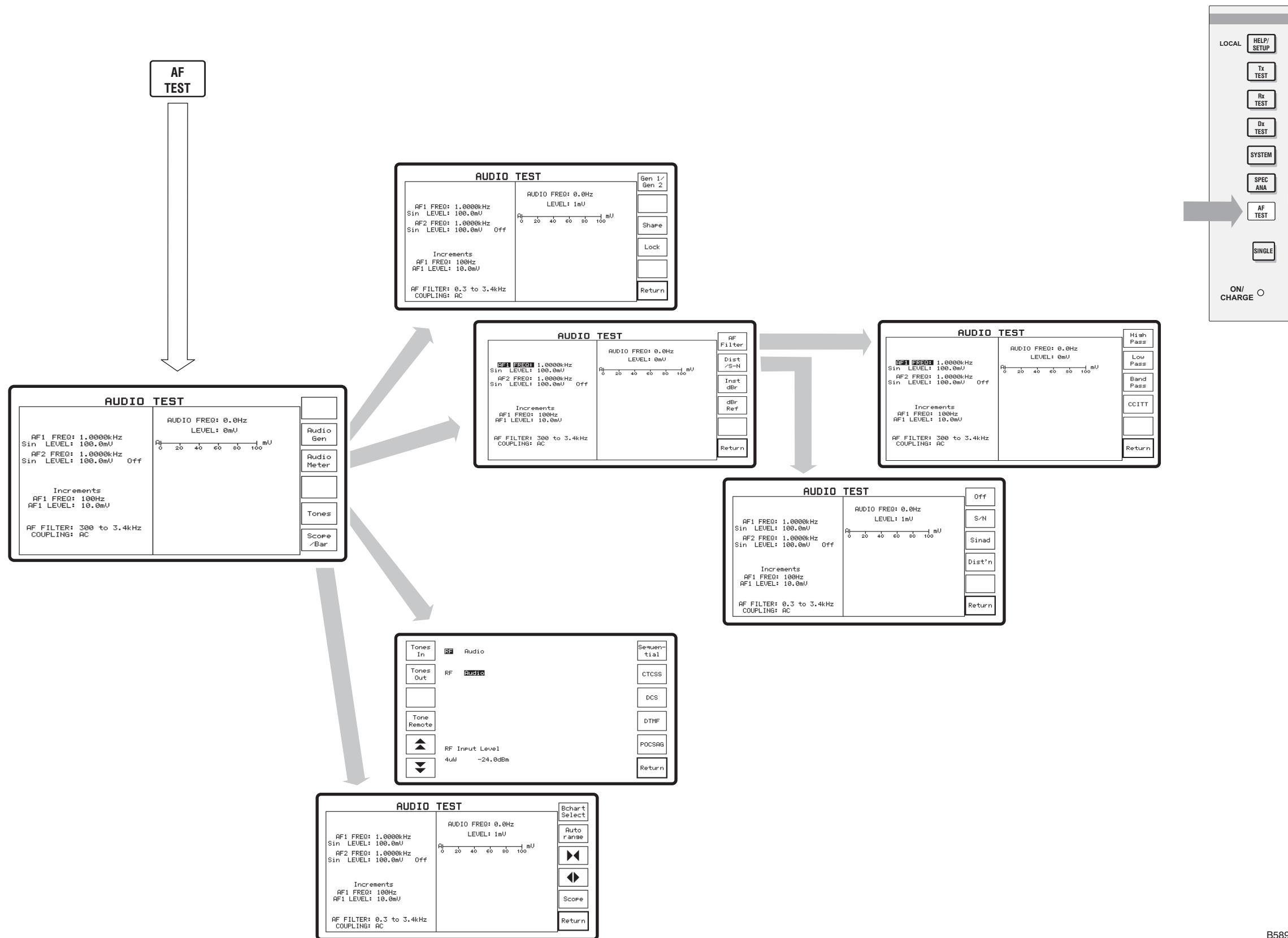

Test mode screen and menu (7.0). AF TEST with next levels.

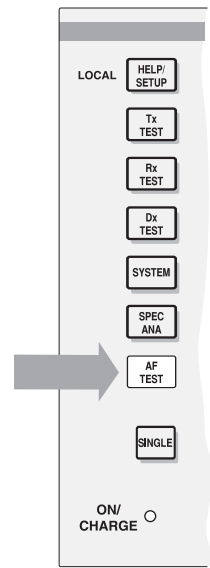

C4188

Fold out diagram number (7.0)

Chapter 4

TECHNICAL DESCRIPTION

Contents

Overview.....	4-1
Power supply	4-2
The display.....	4-3
Tx test mode.....	4-7
Modulation sources.....	4-7
Receiver circuits	4-9
IF circuits	4-10
Demodulators.....	4-11
RF counter	4-12
Measurement ranging circuits.....	4-12
Distortion/SINAD filter	4-12
Oscilloscope function	4-12
Rx test mode	4-13
RF oscillator.....	4-13
Modulators	4-15
RF amplifier.....	4-15
Audio generators.....	4-15
Modulation control	4-15
Pre-emphasis filter	4-15
AF measuring circuits.....	4-15
Oscilloscope function	4-16
Dx test mode	4-16
Spectrum analyzer mode.....	4-16
Look and Listen function.....	4-16
AF test mode	4-16
Systems mode	4-17

List of figures

Fig. 4-1 Block diagram of power supply module.....	4-2
Fig. 4-2 Simplified block diagram	4-5
Fig. 4-3 AF generators, detailed block diagram.....	4-7
Fig. 4-4 Input switching and broad band power meter block diagram	4-9
Fig. 4-5 RF oscillator block diagram	4-14

Overview

This simple description is provided to give the user an insight into the working of the Service Monitor at the block diagram level. See Fig. 4-2, *Simplified block diagram*. A detailed technical description will be found in the maintenance manual relating to this Service Monitor.

The Service Monitor is of modular construction, comprising a number of printed circuit boards, (at least 15, depending on options included). These are housed in two sub-assemblies, along with input and output attenuators, power supply, front panel, rear panel and display unit modules. The Service Monitor is microprocessor controlled and software driven.

The power supply and display unit are described first. The functional circuit blocks of each test mode are then described in sequence.

Power supply

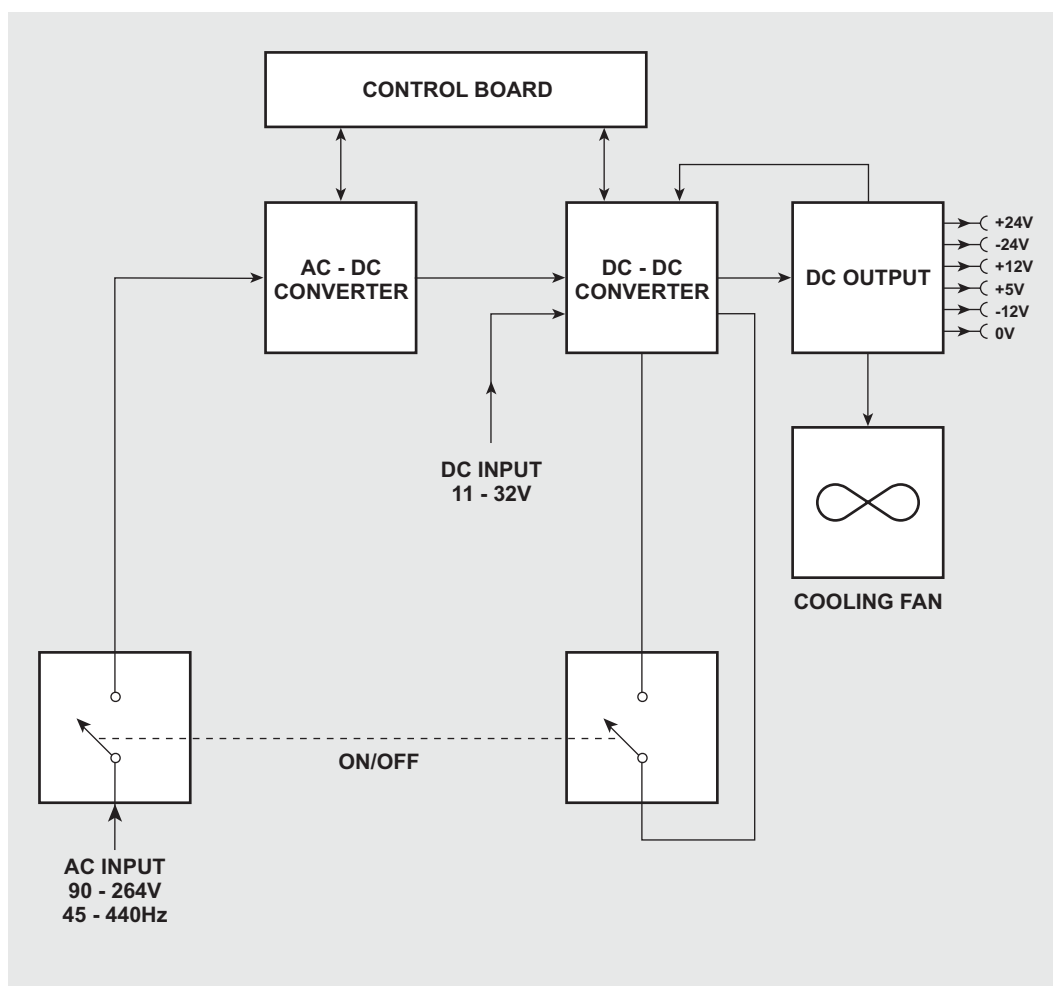

C5903

Fig. 4-1 Block diagram of power supply module.

The power supply module is a switched mode design which will operate from an AC supply of either 100 to 240 V~ at a frequency of 50 to 60 Hz, or within the range 108 to 118 V~, at a frequency of 50 to 400 Hz; or from a DC supply of 11 to 32 V.

The circuits of the Service Monitor require the supplies tabled below:-

+5 V	3.0 A
+12 V	2.5 A
-12 V	1.2 A
36 V	100 mA output

The AC supply enters the instrument through a fused connector on the rear panel and then through two poles of a 3 pole, push-button, ON/OFF switch situated on the front panel. From the switch, the supply then passes to the power supply module. Here it is fed to a bridge rectifier in the AC-DC converter to produce an unregulated DC supply. The voltage of this will depend on the supply voltage, as the full AC input voltage range is covered without range switching.

The second stage of the AC-DC converter produces semi-regulated DC supplies of 12 V and 24 V, using a 60 kHz switched mode oscillator and transformer coupling. This transformer also provides the safety isolation barrier.

The DC-DC converter is driven by either the external DC supply or the DC supply from the AC-DC converter.

The DC output circuits producing the four output supplies are each fed from an individual winding on the DC-DC converter output transformer.

Regulation is applied to the DC-DC converter from the output current and voltage sensing circuits.

Current monitoring to provide regulation is obtained from the three common-return supplies and voltage monitoring from the +5 V supply.

The 36 V output is generated by adding a 24 V floating supply onto the +12 V supply rail. The floating 24 V supply has a voltage regulator configured within it.

A control circuit PCB contains the components for frequency control and voltage regulation of both converters.

The external DC supply is not switched directly; the 3rd pole of the power ON/OFF switch controls the DC-DC converter, thereby switching the DC supply to the Service Monitor.

The display

The display device is a color transfective TFT liquid crystal display module with an active viewing area 143 mm x 80 mm. It comprises the display module, a driver board, and a cold cathode fluorescent tube (CCFT) backlight.

The viewing area is composed of a 1200 X 240 RGB dot matrix. Each pixel is sequentially addressed with a 6-bit data bus to determine its color and intensity. The display contrast is fixed, but the brightness can be adjusted over a small range by varying the backlight drive. This is achieved by generating a programmable voltage on the microprocessor board and feeding it to the backlight inverter, mounted on the rear of the display module. The inverter produces approximately 1500V for the CCFT backlight. In high ambient light conditions the backlight can be switched off to conserve battery power.

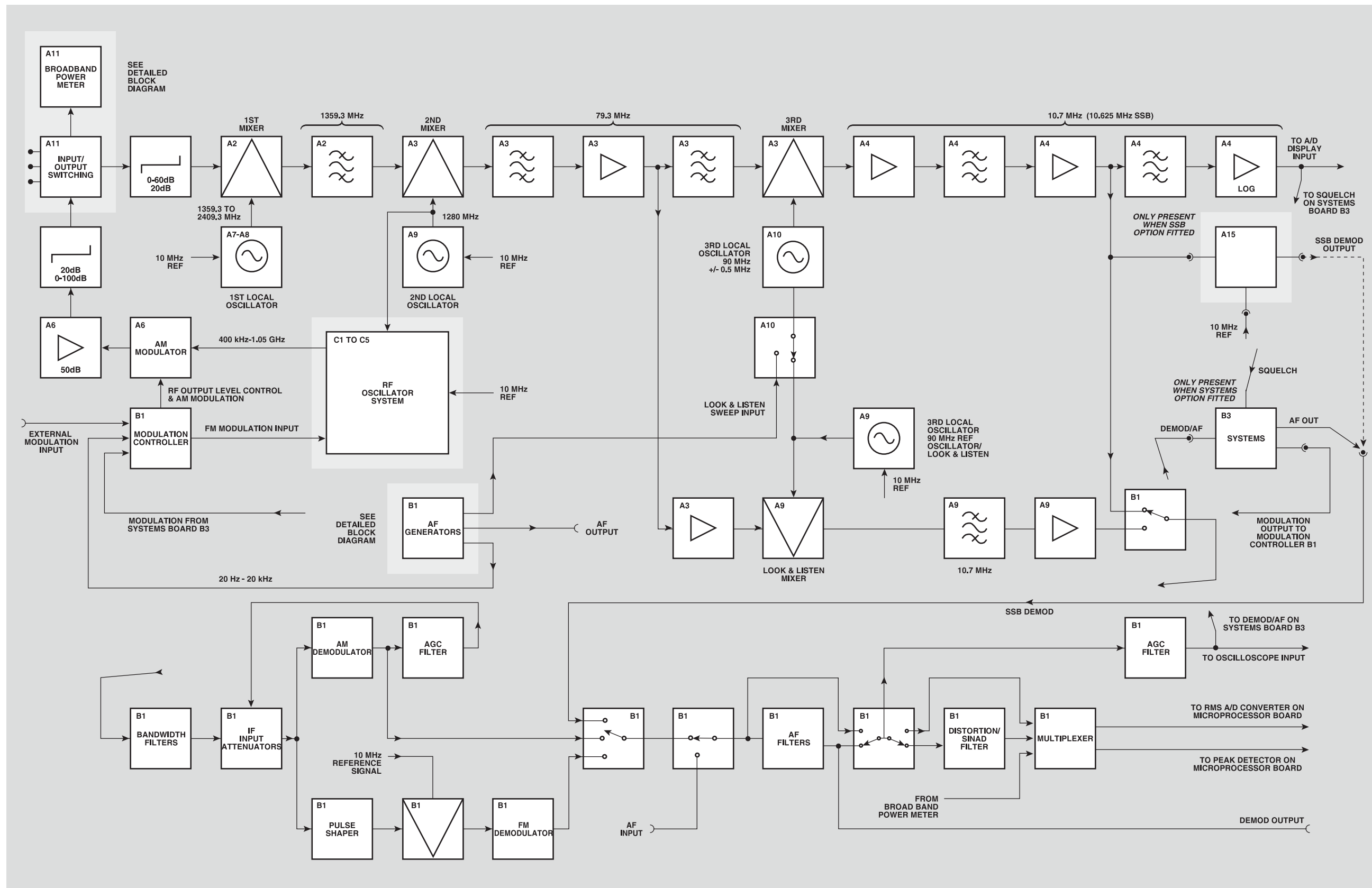

C2660

Fig. 4-2 Simplified block diagram

To Printer: Trim A3 printed sheets by 0.75" (19mm) from right edge to clear binder.

Tx test mode

When operating in the Tx TEST mode the Service Monitor has to provide a source of modulation for the transmitter being tested, and also analyze the RF output signal from the transmitter.

Modulation sources

The modulating signal is provided by one or both of the audio generators or the data generator and is taken from the AF GEN OUT connector on the front panel.

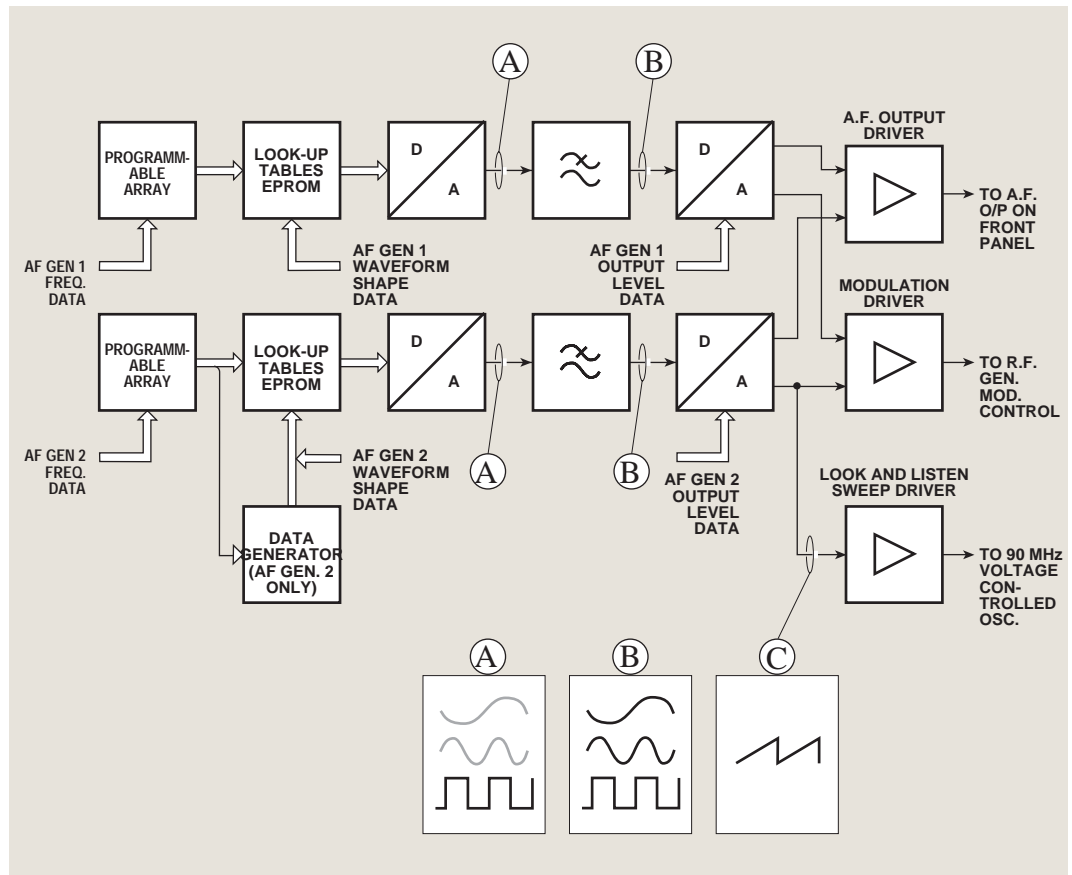

C1412

Fig. 4-3 AF generators, detailed block diagram

Audio generators

The Service Monitor has two AF generators, shown as 'AF generators' on the simplified block diagram. A detailed block diagram of the AF generators is given in Fig 4-3. These are used as modulation sources for the Tx, Rx and Dx TEST modes and as audio test signal generators in the AF TEST mode. They have a frequency range of 20 Hz to 20 kHz and the output waveform of either generator can be sine wave or square wave. Both generators are of similar design, with minor variations. The generator designated 'GEN 2' is also used for other functions which do not conflict with its functions as an audio generator. These uses will be mentioned where relevant.

Each of the circuits function in the following manner:-

Instruction as to the frequency of the required signal is latched into a programmable array device, which generates a repetitive digital output sequence recurring at the required frequency. The digital output from the programmable array is transferred as a stream of 13 bit parallel data into an EPROM. This holds look-up tables containing shape details of sine wave and square wave signals. Output from the EPROM is as 8 bit, parallel information, corresponding to the selected shape and at the repetition frequency instructed by the information latched into the programmable array device.

The EPROM output is applied to a digital to analogue converter which, by converting each digital value to the corresponding analogue level, produces the required signal. The mean output level from the digital to analogue converter is constant. The analogue output is filtered by a 50 kHz low-pass active filter, to remove any spikes created by the digital generation process. The output from the filter has a peak to peak level of 5.7 V.

Output level is controlled by a digital to analogue converter, configured as a digital level control circuit. The constant level AF signal is applied to the reference voltage level input, while the digital input register is supplied with the data relating to the level of output signal required. The output from the digital to analogue converter will be a replica of the signal at the reference voltage terminal but proportionally reduced, relative to the data values at the digital input terminals.

After buffering, the AF generator outputs are switched to the AF output drivers for impedance matching, prior to routing to the AF GEN OUT connector on the front panel. The output level available at the AF GEN OUT connector is infinitely variable from 0.1 mV to 4.0 V RMS.

Note: The AF generators are also used as modulation sources for receiver testing. Therefore the options available to the user when carrying out duplex tests are :-

Both generators to modulate the transmitter under test, receiver test signal not modulated.

Both generators to modulate the receiver test signal, transmitter under test not modulated.

One generator to modulate the transmitter under test and one to modulate the receiver test signal.

Data generator

The data generator is a 'D type' flip-flop, used to control AF generator 2 when pulsed tones are required as modulation, such as for Digitally Coded Squelch applications. The Q1 output of the data generator IC is used as the A13 address line on the lookup table EPROM. The data generator will thereby directly switch this line, which is arranged to cause full output or no output. The result is that data applied to the flip-flop D2 input will appear as tone pulses at the output of AF generator 2.

When not required to produce data, the data generator is configured as a transparent flip-flop, with the A13 address line functioning normally.

Receiver circuits

Input switching

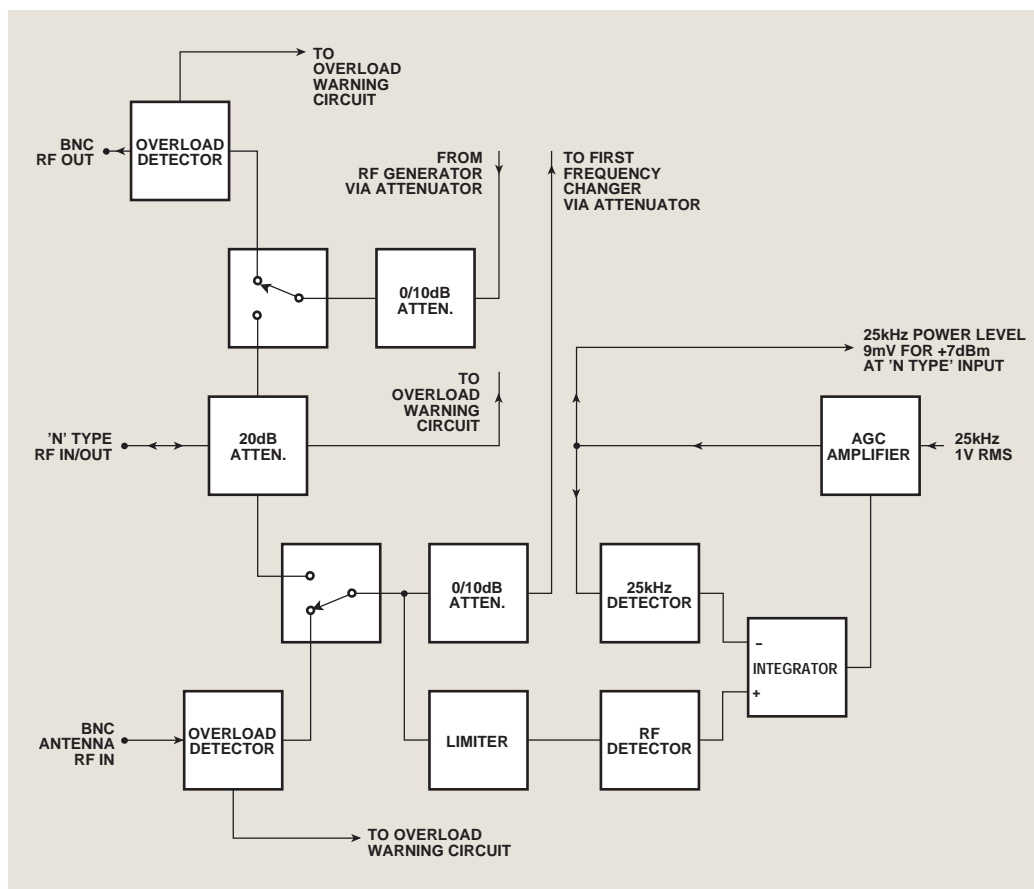

C1411

Fig. 4-4 Input switching and broad band power meter block diagram

The RF signal from the transmitter under test enters the Service Monitor at either the BNC antenna input or the 'N type' connector on the input/output switching board A11/1. A detailed block diagram of this board is shown in Fig. 4-4, *Input switching and broad band power meter block diagram*.

The 'N type' connector, which is also used as an output for receiver testing, has a 20 dB power attenuator between it and the input/output switching circuits. A 10 dB attenuator pad can be switched into the transmitter test RF path by the Service Monitor software.

Broad band power meter

A proportion of the input signal is fed directly to the broad band power meter circuits. The RF signal is passed through a diode detector, and the resultant DC signal integrated with a similar signal derived from a 25 kHz signal from board B2/1. As the integration is carried out using the inverting and non-inverting inputs of an op-amp, a stable condition will result when the two inputs are of the same value.

The output from the integrator is used as a control signal for an AGC amplifier acting on the 25 kHz signal, with the output from the AGC amplifier supplying the integrator. The loop will therefore remain stable, with the AGC amplifier output voltage exactly equaling the voltage of the RF input to the detector. This voltage is taken to the voltmeter ranging circuits on the audio processor board (B1/1 or B1/2,) and then to the AF voltmeter circuit on the microprocessor board B2/1.

Overload detection

An overload detection circuit is activated if power in excess of 1.0 W is applied to the BNC antenna connector or to the BNC RF output connector. The overload detect lines are activated and trigger the overload warning message from the microprocessor. A temperature sensor is in physical contact with the 20 dB pad on the 'N type' connector. This triggers the overload circuit in the event of excessive power being applied to that connector.

Switched attenuator

A switched attenuator, with one 40 dB pad and one 20 dB pad, is situated between the input switching board A11/1 and the 1st frequency changer/mixer board A2. This provides attenuator values of 0 dB, 20 dB, 40 dB and 60 dB.

IF circuits

First frequency changer/mixer

The RF signal from the switched attenuator enters the 1st frequency changer/mixer board A2 and passes through an overload prevention circuit. This limits any input signal to approximately 0.7 V peak. The signal then passes either directly, or through a 20 dB amplifier, to the 1st mixer.

First local oscillator

The mixer is also supplied with a signal from the 1st local oscillator board A8/1. This oscillator is a fractional 'N' controlled oscillator, which can be made to run at any frequency between 1.36 and 2.36 GHz, in increments of 1 Hz. The actual frequency is determined by the control system of the monitor. If the transmitter test frequency is known, and has been entered into the monitor as a 'Tx FREQ' using the data input keys, the oscillator will be made to run at a frequency 1.3593 GHz above this value.

By mixing this signal with that from the input circuits, the output from the mixer will contain a signal of 1.3593 GHz.

When the 'Auto Tune' function is active, the variable oscillator is made to sweep through its operating range. The sweep rate is slowed when a signal is detected at the demodulators, and the oscillator brought into lock.

Filtering in the mixer output removes the upper frequency components of the mixing process.

Second frequency changer/mixer

The signal from the 1st mixer is further reduced in frequency by a 2nd frequency changing mixer to produce an output of 79.3 MHz. This is on the 2nd and 3rd mixer board A3. The signal arriving at board A3 is 1st passed through a 1.3593 GHz band-pass filter and applied to the input of the 2nd mixer.

Second local oscillator

The local oscillator for the 2nd mixer produces a 1.280 GHz signal on the 2nd and 3rd oscillator board A9/1. This oscillator is a phase locked loop device, locked to the 10 MHz reference oscillator.

The output from the 2nd mixer is passed through a 79.3 MHz band-pass filter to remove the unwanted products of the mixing process, then given 20 dB amplification.

The 2nd IF signal is split and fed to two independent mixers.

The secondary feed supplies the 90 MHz swept local oscillator board A10. This operates as a swept oscillator when the spectrum analyzer Look and Listen function is active, as described later. It provides a locked 90 MHz signal for the 3rd mixer at other times.

The primary path is through a band-pass filter with 5 MHz bandwidth, to the main 90 MHz 3rd mixer. This mixer is on the 2nd and 3rd mixer board A3.

Third frequency changer/mixer

A 3rd frequency change is made to the signal to achieve a final IF of 10.7 MHz.

The local oscillator signal for the 3rd mixer is provided by the voltage controlled oscillator on the 2nd and 3rd oscillator board A10. This oscillator runs at 90 MHz and for normal transmitter testing is locked to the output of a 90 MHz reference oscillator on the 2nd and 3rd oscillator board A9/1.

Bandwidth filters

The 10.7 MHz output from the 3rd mixer passes to the 10.7 MHz IF and Log amplifier board A4/1.

Filters on this board provides the bandwidth filtering for the signal path in the Tx TEST mode and also for the SPEC ANA mode. The bandwidths provided are 3 MHz, 300 kHz, 30 kHz, 3 kHz and 300 Hz, using crystal filters controlled by signals from the microprocessor.

A direct, unfiltered path is also provided.

After filtering, the signal is passed to the demodulators on the audio processor board (B1/1 or B1/2).

Demodulators

AM demodulator

The demodulators are located on the audio processor board (B1/1 or B1/2). The IF signal, from the IF and Log amplifier board A4/1, is fed to a phase splitter circuit which provides anti-phase outputs for the AM demodulator. The outputs from the phase splitter are taken to the positive and negative inputs of the balanced demodulator. The demodulator is also fed with balanced, unmodulated inputs, obtained from the modulated 10.7 MHz signal, by way of a phase-splitting limiter.

The demodulator produces a balanced output equal to the difference between the two input signals. This will have an AF component equaling the modulation signal and a DC component relating to the level of the IF signal. The modulation is fed to the AF switching circuits and the DC component used for automatic gain control.

FM demodulator

FM demodulation is performed by a pulse width discriminator operating at 700 kHz. The signal for this is obtained by mixing the 10.7 MHz output from the limited signal fed to the AM demodulator with the 10.0 MHz reference frequency, and passing the resultant signal through a low-pass filter.

The 700 kHz signal containing the FM information is fed into a both halves of a dual monostable flip-flop. By putting this signal to A1 and B2 inputs, the Q- outputs from the monostables will be in anti-phase. By summing the two output signals the resultant signal will be a true representation of the modulation.

SSB demodulator (optional)

The single sideband demodulator circuits are all contained on the SSB demodulator board A15.

When the SSB demodulation function is selected the 1st local oscillator of the Service Monitor is set to a frequency which will produce a final IF of 10.625 MHz (from an input frequency equal to the carrier frequency) rather than the 10.7 MHz IF produced for all other modes. The IF signal for the SSB board is obtained from the 3rd mixer on A3, through a 10.7 MHz low-pass filter on A4/1.

It is applied to a variable gain circuit which is used to control the input level for the SSB demodulator circuits.

After leaving the gain control circuit, the signal is then mixed in a double balanced mixer with a 10 MHz signal from the reference oscillator. The output from the mixer will contain a 625 kHz component. This is passed through a 625 kHz low pass filter to one input of another double balanced mixer. The second input is fed with a reference signal of 625 kHz derived from the 10 MHz reference through a 'divide by 16' circuit. The output from the double balanced mixer will be zero when no modulation is present on the input signal. When modulation is applied, the output signal will equal the difference in frequency between the original carrier frequency and the original sideband frequency. Either an upper sideband signal or lower sideband signal will produce an output. This will equal the frequency of the applied modulation. The demodulated signal is fed to the input of the audio routing circuits.

De-emphasis filter

The output from the discriminator passes through a 163 kHz low-pass filter and then the 750 μ s de-emphasis filter before being routed by the demodulation selection switches. The de-emphasis filter can be by-passed as part of the test set-up.

RF counter

A sample of the 10.7 MHz IF signal is taken from one output of the phase splitter/limiter and supplied to the IF counter circuit, also located on the audio processor board (B1/1 or B1/2).

This measures the mean frequency of the IF signal and the result is written into memory. By making a calculation using the reading from the RF counter and the division ratios from the three local oscillator control loops, the Service Monitors software can establish the mean frequency of the transmitter output.

Measurement ranging circuits

The evaluations of RF level, modulation depth, modulation deviation, distorted levels etc. are all made using a metering circuit on the microprocessor board B2/1. Before the various levels can be measured, each must be conditioned so as to bring the minimum and maximum levels of each parameter within the range of the metering circuit. The signals to be measured are all brought to the analyzer ranging circuits on the audio processor board (B1/1 or B1/2). Signals relating to RF power input to the Service Monitor and power readings from optional auxiliary power heads are passed through various switched gain amplifiers before leaving the board to be measured.

Demodulated AF signals are passed through any selected AF filters before being measured. The selected filters are switched into the AF circuit before the ranging amplifiers. The AF filters are located on the audio processor board and offer the choice of 300 Hz - 3.4 kHz band-pass; 15 kHz low-pass; 300 Hz low-pass and the full bandwidth of 50 kHz. There are CCITT and CMESS filters available as options.

Distortion/SINAD filter

The 1.0 kHz active notch filter, used to make distortion percentage and SINAD measurements, is also on the audio processor board (B1/1 or B1/2). This filter is switched into circuit to make comparison measurements against the unfiltered path.

Oscilloscope function

The oscilloscope function when used within the Tx TEST mode displays the waveform of the demodulated signal. The signal for this is taken from the AF filter output and after passing through level converting amplifier circuits is fed to an analogue to digital converter located on the microprocessor board B2/1. The digital levels relating to the waveform are written into a digital signal processor which generates the oscilloscope display. The values are incorporated into the display and updated continually. The display persistence function is also generated within this DSP.

Rx test mode

The Rx TEST mode requires a modulated RF signal to be fed to the receiver. The AF signal produced by the demodulator within the receiver, is analyzed to produce results of the test.

Selecting the Rx TEST mode does not disable the functions of the Tx TEST mode. The receiver circuits remain active at their last settings. The AF generators will also continue operating at their last settings unless either is enabled as a modulation generator. Calling up one modulation generator will allow the other to function as an AF generator for Tx testing, but using both as modulation sources will remove both from Tx test use.

RF oscillator

Refer to the overall block diagram, Fig. 4-2, *Simplified block diagram* on page 4-5, and the detailed block diagram of the RF oscillator in Fig. 4-5 on page 4-14.

A signal in the frequency range 576 - 1152 MHz is generated on RF oscillator board C2, passed to an amplifier and splitter.

One output from the splitter is passed to the RF generator control board C1, where it is divided down to 2.5 MHz under Fractional N control and fed back to the RF oscillator board C2. This signal is compared with a 2.5 MHz signal derived from the 10 MHz standard. The error signal is loop filtered and used to lock the oscillator.

The second RF output from the splitter on the RF oscillator board C2, is fed to the RF divider board C3. On this board the signal is routed through a series of filters which selects sub-harmonics of the original signal so as to divide it by factors of 2, 4, or 8.

The frequency range of the RF signal is therefore extended to cover 72 - 1050 MHz

The signal on the output of the RF divider board C3 is routed to bypass board C4. For RF generator output frequencies above and including 72 MHz, the signal is routed across C4 to the output amplifier board A6/1.

When a signal generator output within the range 400 kHz to 72 MHz is required, the output signal from the RF divider board C3 is routed from the bypass board C4 to the beat frequency oscillator board C5. The frequency range of signal fed to the beat frequency oscillator board C5 is within the range 320.4 MHz and 391.999999 MHz. A 1280 MHz signal from A9/1 is divided by 4 (to produce a 320 MHz signal) and mixed with the signal from the bypass board C4. These two signals are mixed and the resultant signal of 400 kHz to 71.999999 MHz is amplified, then filtered off, routed back to the bypass board C4, then to the Output Amplifier board A6/1.

TECHNICAL DESCRIPTION

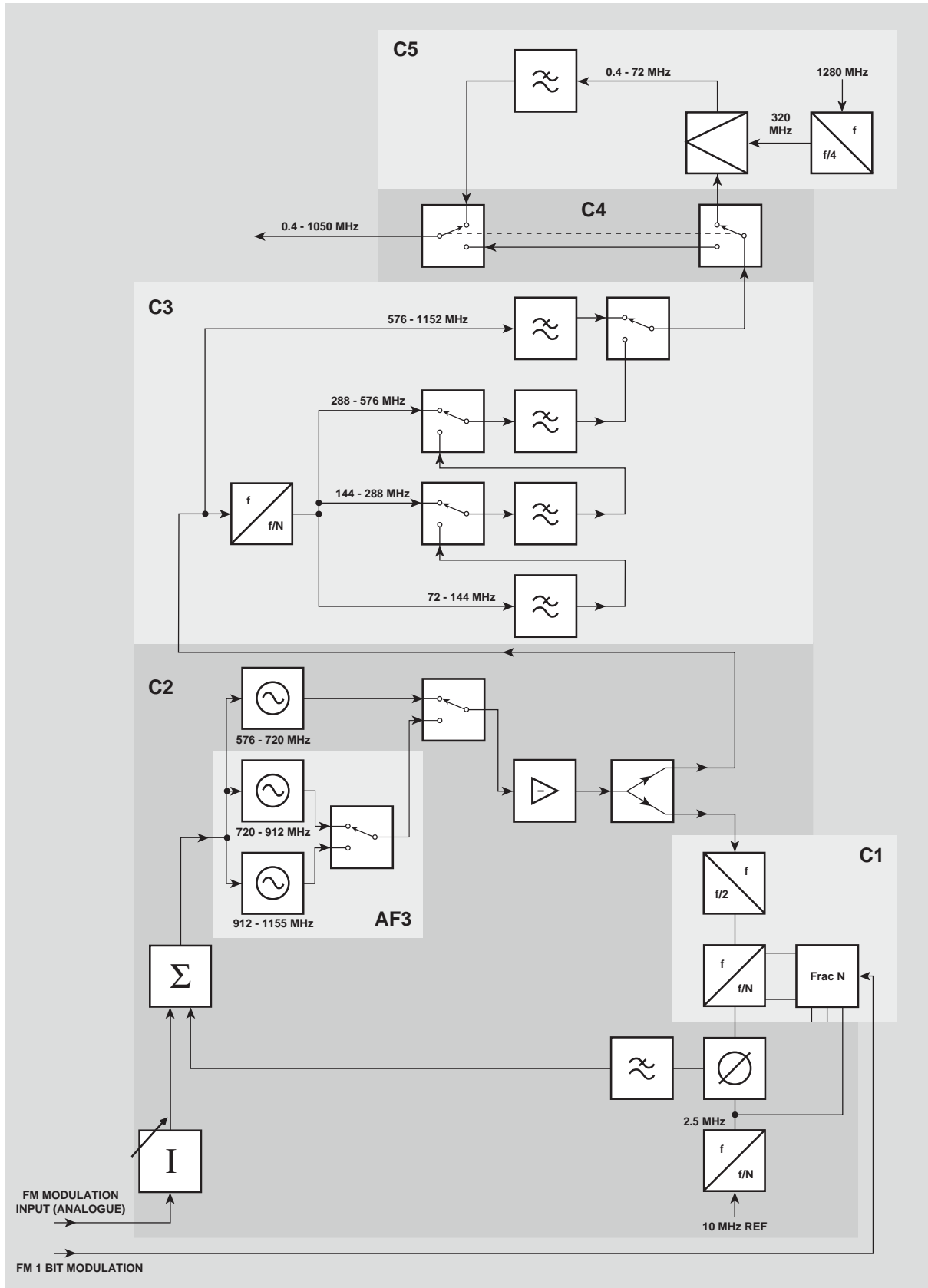

C3260

Fig. 4-5 RF oscillator block diagram

Modulators

The Rx TEST signal can be either AM or FM modulated.

The selected modulation signal, is obtained from either or both of the AF generators, from the data generator or from an external source. It is conditioned and level corrected within the modulation control circuits on the audio processor board (B1/1 or B1/2).

Frequency modulation is applied by injection into the fractional N control loop, thereby influencing the generated frequency. When the signal is FM modulated, the AM modulator is held in a 0% modulation state.

AM modulation is applied to the signal using a pin diode modulator, located within the output amplifier circuits on A6/1. The output level of the Rx TEST signal is also controlled using the pin diode modulator.

The signal controlling the attenuation level of the pin diode modulator, is a composite signal containing the amplitude modulation component obtained from the modulation source and a DC component representing the required output level.

They are combined into one modulation signal using a digital to analogue converter on the audio processor board (B1/1 or B1/2).

RF amplifier

The signal level from the AM modulator is increased by 50 dB by a three stage RF amplifier before passing through the output control attenuator to the RF switching unit and the RF output sockets.

Audio generators

The audio generators on the audio processor board (B1/1 or B1/2) are used to provide AF Modulation to the RF test signal generated on the RF generator oscillator board A13/1. The operation of the generators is as described for the Tx TEST mode but rather than the output level being called up as an output voltage, this is specified as a modulation level. The necessary calculations are performed by the Service Monitor's software.

The DATA GENERATOR facility is available in the Rx TEST mode.

Modulation control

The output from each generator is taken through selector switches to a summing amplifier at the input to the modulation control circuits. The signal from an external modulation source or from the modulation options circuits is also summed in at this point. An external modulation source can be connected to the EXTERNAL MOD IN connector on the rear panel. This is passed through a level control circuit similar in design to that in the AF generator circuit.

The summed modulation signal is taken through a modulation correction level control circuit, then routed to either the FM attenuator D to A converter or to the RF level D to A converter. The latter provides fine level control of the RF signal by applying a DC level to the AM modulator as described earlier.

Pre-emphasis filter

A 750 μ s pre-emphasis filter is included on the audio processor board and when selected, is switched into the FM modulation path as part of the Rx TEST set-up.

AF measuring circuits

The AF output signal from the receiver under test is connected to the AF INPUT connector of the Service Monitor. This is routed to a switched $\div 2/\times 20$ circuit on the audio processor board (B1/1 or B1/2), then split and routed to the AF filtering and measuring path and to the oscilloscope input circuits.

Oscilloscope function

When used in the Rx TEST mode, the oscilloscope displays the AF input signal fed to the AF input connector. The signal is passed through a sensitivity control circuit for scope calibration before following the same path as used in the Tx TEST mode.

Dx test mode

The Dx TEST mode uses all the circuit elements described in the preceding sections. The technical description is valid for all three modes. The display presentation allows parameters applicable to transmitter testing and receiver testing to be seen simultaneously.

Spectrum analyzer mode

Data to be presented as the active trace on the spectrum analyzer display is obtained through the following circuits:-

The 1st local oscillator, located on A7/1, is made to sweep through the frequency range selected on the display. Any signals which fall within the sweep range will pass through the IF circuits of the Service Monitor.

The input frequency of the Service Monitor is made to sweep through the frequency range selected on the display by sweeping the 1st local oscillator, located on A7/1. Any signals which fall within the sweep range will pass through the IF circuits of the Service Monitor. The output from the 3rd mixer is amplified and filtered on A4/1, then fed to a logarithmic amplifier. The 10.7 MHz signal is detected to produce a DC signal, the level of which is relative to the level of the RF signal input. The DC voltage is digitized by an analogue to digital converter on the Microprocessor board B2/1.

The digital value obtained is stored in RAM at a memory location which is related to the sweep position and to the value.

Each time the display is refreshed, the contents of each display location address will provide the latest data, thus updating the display. The refresh rate is approx. 11 per second.

Look and Listen function

When the Look and Listen function of spectrum analyzer mode is selected, the operation is modified. In order to demodulate the center frequency of the span, the signal fed to the demodulator must be obtained from a fixed frequency point. As the frequency span in the Look and Listen function is limited to 2 MHz, the frequency sweep can be applied at the 3rd mixer stage. A ramp voltage is generated within AF generator 2 on the audio processor board (B1/1 or B1/2) and applied to the 90 MHz voltage controlled oscillator on A10. The 10.7 MHz IF signal will thus have swept over the selected range to produce a Frequency vs Signal Level display.

The signal fed to the modulator meter is obtained from the Look and Listen 3rd mixer, located on the 2nd and 3rd local oscillator board A9/1. The demodulated AM or FM signal is amplified, to provide a low impedance output which is fed to the loudspeaker. It is also fed to the ACCESSORY connector on the front panel.

A 90 MHz reference oscillator on A9/1 provides the local oscillator signal for this mixer. It also provides a 90 MHz reference for the 90 MHz voltage controlled swept oscillator on A10.

AF test mode

The AF TEST mode requires a signal source to apply to the circuit or equipment under test and a measuring facility to analyze the resultant output signal.

The signal source is provided by the audio generators as for the Tx TEST mode and the AF measuring circuits configured as for the Rx TEST mode. The RF generator and IF local oscillators are disabled. The power metering and modulation metering functions are also disabled.

Systems mode

The systems mode of the Service Monitor allows it to test communications equipment which is designed for operation on dedicated systems such as cellular mobile radio telephone systems and trunking radio telephone systems. Automatic testing is performed using various test programs. These can be made to check all functions of the system, the signaling only or any intermediate choice of functions, depending on the user's requirements.

The data processing needed to carry out these tests is handled by a 68000 microprocessor and three Digital Signal Processors (DSPs) on the cellular radio systems board (B3 or B3/1).

The board has 1 M byte of EPROM which contains the cellular systems software and the built-in test sequences.

The user defined sequences and user set-ups are held in 256 k byte of NOVRAM.

One of the DSPs generates the signals required to simulate the system signals, the other two handle the signals received from the mobile.

A gate array is used for communication between the 68000 microprocessor and the DSPs.

Interfacing between the digital circuits on the cellular radio systems board (B3 or B3/1) and the analogue circuits of the Service Monitor is handled by a dual 18-bit digital to analogue converter for the Service Monitor to mobile signals and by a 12-bit analogue to digital converter for signals from the mobile.

Chapter 5

ACCEPTANCE TESTING

Contents

Introduction.....	5-2
Results tables	5-2
Before starting	5-2
Test equipment.....	5-3
RF output tests	5-4
Carrier frequency accuracy.....	5-4
RF output level	5-6
ALC linearity.....	5-6
BNC output mode.....	5-7
Attenuator accuracy.....	5-7
Alternative attenuator functional check.....	5-8
Spectral purity.....	5-9
Harmonics, spurious, RF carrier leakage, residual FM	5-9
Amplitude modulation	5-11
Frequency modulation	5-12
AF output tests	5-13
Audio generator output level	5-13
Audio generator distortion	5-14
Audio generator frequency	5-15
AF input tests	5-16
Audio frequency meter	5-16
Audio voltmeter	5-17
AF distortion & SINAD meter.....	5-18
RF input tests	5-19
Modulation analyzer - FM	5-19
Modulation analyzer - AM	5-22
RF frequency meter	5-24
RF spectrum analyzer	5-26
RF broadband power meter.....	5-28
Signalling systems	5-29
Acceptance Test Results Tables.....	5-31

List of figures

Fig. 5-1 Carrier frequency accuracy	5-4
Fig. 5-2 RF level set up.....	5-6
Fig. 5-3 RF level set up.....	5-7
Fig. 5-4 Attenuator functional check	5-8
Fig. 5-5 Carrier harmonics & spurious check.....	5-9
Fig. 5-6 Residual FM checks	5-10
Fig. 5-7 Internal AM accuracy checks.....	5-11
Fig. 5-8 Internal FM accuracy checks.....	5-12
Fig. 5-9 Audio generator level accuracy checks.....	5-13
Fig. 5-10 Audio generator signal purity checks.....	5-14
Fig. 5-11 Audio frequency meter check.....	5-16
Fig. 5-12 Audio voltmeter level accuracy checks.....	5-17
Fig. 5-13 Modulation meter FM	5-20
Fig. 5-14 Modulation analyzer - AM.....	5-22
Fig. 5-15 RF frequency meter	5-24
Fig. 5-16 RF spectrum analyzer checks	5-26
Fig. 5-17 RF broadband power meter checks	5-28

Introduction

Test procedures described in this chapter may be simplified and of restricted range compared with those that relate to the generally more comprehensive factory test facilities which are necessary to demonstrate complete compliance with the specifications.

Performance limits quoted are for guidance and should not be taken as guaranteed performance specifications unless they are also quoted in the section *Performance data* in Chapter 1.

Note

When making tests to verify that the instrument meets the stated performance limits, always allow for the uncertainty of the test equipment.

Results tables

A set of Results tables, each with a blank results column, is provided at the end of this chapter. It is suggested that these tables are copied, and the test results entered on the copies.

The Results table that is appropriate to each particular test or part of a test is referred to at the relevant point in the test procedure.

Before starting

In line with best practice in electronic measurement, it is recommended that the Unit Under Test (UUT) is allowed to stabilize for thirty minutes after switch on to obtain optimum performance.

To minimise the number of key presses that the user needs to make to obtain the correct instrument settings, each section assumes that the instrument is being configured from the instrument 'factory default power on state'. To ensure that this occurs, initially press the following keys: [HELP/SETUP], [*Setup*], [*Setup page 2*], toggle [*Power Up From*], until *Preset Store 1* is shown highlighted in inverse video. Each time the instrument is now powered up, it will enter its default power on state.

The instructions relating to test equipment operation assume that the test equipment used for each test is that suggested in the *Example* column of the following table (where there is more than one, the first item).

ACCEPTANCE TESTING

Test equipment

Description	Minimum specification	Example
Frequency counter	400 kHz to 1.05 GHz 1 Hz resolution, external standard In/Out	IFR* 2440 or EIP 25B
RF power meter	± 0.1 dB from 10 MHz to 1 GHz	IFR* 6960/A/B + 6912 and 6920 sensor
Measuring receiver	-21 dBm to -127 dBm, 2.5 MHz to 1 GHz	HP 8902A + 11772A sensor
Spectrum analyzer	400 kHz to 3 GHz, noise floor < -127 dBm	IFR* 2383
Low-noise FM demodulator	Residual FM to be less than 2 Hz up to 1 GHz	IFR* 2305 + IFR* 2041
Modulation meter	RF I/P 500 kHz to 1.05 GHz AM. Measurement accuracy up to 85% depth: ± 1% of reading at 1 kHz mod rate, ± 2.5% of reading for mod rates from 30 Hz to 50 kHz RF I/P 500 kHz to 1.05 GHz FM. Measurement accuracy ± 0.5% of reading ± 1 least significant changing digit at 1 kHz mod rate for deviation > 5 kHz	IFR* 2305
DVM	1 % accuracy AC measurement, 20 Hz to 50 kHz DC measurement to 1 mV	Solatron 7150+
Audio analyzer	Capable of measuring distortion from 1 kHz to 15 kHz down to 0.1% and AC measurement in a CCITT bandwidth	IFR* 2965/ HP 8903B
LF generator	50 Hz to 50 kHz, external frequency standard In/Out, 30 mV to 5 V RMS	IFR* 2965/ HP 3325
RF signal generator	100 kHz to 1.05 GHz, RF level accuracy ± 1 dB AM depth 0 to 95%, deviation 0 to 75 kHz Modulation rate 10 Hz to 15 kHz	IFR* 2041
Power splitter	6 dB 50 Ω 500 kHz to 1 GHz	Weinschel 1870A
DC PSU	0 to 50 V	
Calibrated power source	Accuracy 3.5% up to 1 GHz	See broadband power test

*IFR Ltd was previously known as Marconi Instruments Ltd

The minimum specifications for the test equipment listed above cover *all* requirements for these tests. The minimum specifications for the test equipment listed at the start of each test description apply to that test only.

RF output tests

Carrier frequency accuracy

This check provides a conventional method of checking the signal generator's frequency locking circuitry. It will confirm correct operation of phase lock loop and dividers. Overall accuracy is determined by the instrument's internal reference standard.

Specification

Frequency range:	400 kHz to 1.05 GHz
Accuracy:	As frequency standard
Resolution:	10 Hz

Test equipment

Description	Minimum specification	Example
Frequency counter	400 kHz to 1.05 GHz , 1 Hz resolution, external standard In/Out	IFR 2440 or E.I.P.25B

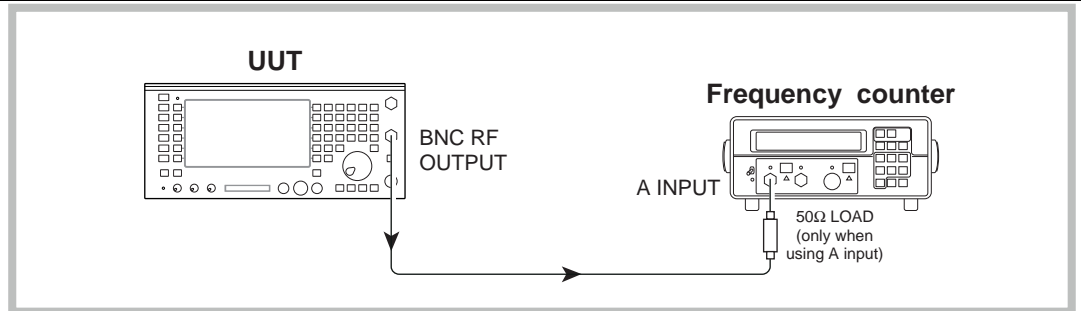

C2580

Fig. 5-1 Carrier frequency accuracy

- (1) Refer to Results table 5-1 on page 5-31. Connect the BNC RF output socket on the UUT to the A input on the counter (2440), as shown in Fig. 5-1. The connection to the A input should be made via a 50 Ω load, otherwise miscounting could occur.
- (2) Lock the reference standards of the instruments together.
- (3) Set the UUT to [Rx TEST], RF IN/OUT [SELECT] BNC output, [RF Gen], [LEVEL] 0 dBm, [FREQ] 400 kHz. All modulation and noise measurements should be switched OFF.
- (4) Set the counter to 1 Hz resolution.
- (5) Check that the counter reads between 399.999 and 400.001 kHz.
- (6) Repeat for the remaining frequencies shown in Table 5-1, checking that the counter displays the selected frequency ± 1 Hz. It will be necessary to disconnect the 50 Ω load and reconnect the UUT RF output to the A, B or C input of the counter where indicated.

ACCEPTANCE TESTING

Table 5-1 Carrier frequencies

Frequency	UUT area checked	2440 range
400.000 kHz	Oscillator, bottom	A
1050.00000 MHz	Oscillator, top	C
500.00000 MHz	Oscillator, middle	B
188.88888 MHz	<div style="display: flex; align-items: center; justify-content: center;"> } Fractional N } </div>	B
177.77777 MHz		B
166.66666 MHz		B
155.55555 MHz		B
144.44444 MHz		B
133.33333 MHz		B
122.22222 MHz		B
111.11111 MHz	B	

RF output level

Specification

Level range: -141 dBm to -21 dBm (N-type socket)

Accuracy: ± 2 dB up to 1 GHz

Test equipment

Description	Minimum specification	Example
RF power meter	± 0.1 dB from 10 MHz to 1 GHz	IFR 6960/A/B + 6920 sensor
Measuring receiver	-21 dBm to -127 dBm, 2.5 MHz to 1 GHz	HP 8902A + 11772A sensor
Spectrum analyzer	Noise floor < -127 dBm	IFR 2383

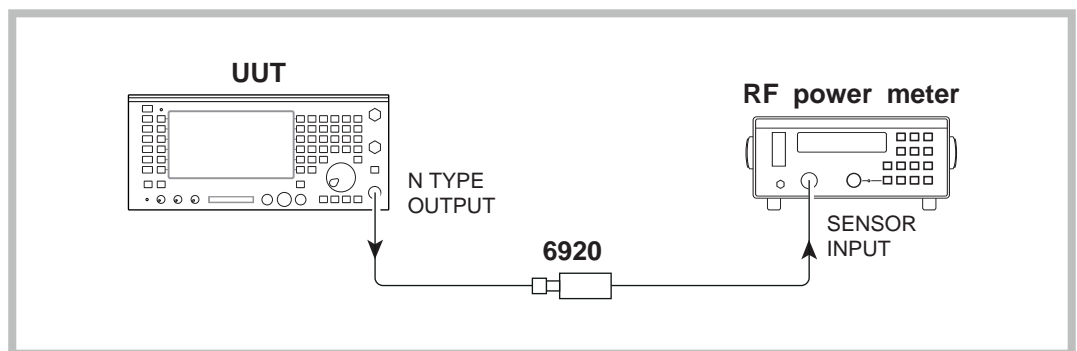

C2581

Fig. 5-2 RF level set up

- (1) Refer to Results table 5-2 on page 5-31. Connect the sensor to the UUT N-type output socket, as shown in Fig. 5-2.
- (2) Set the UUT to [Rx TEST], RF IN/OUT [SELECT] N-type output/antenna input mode, [RF Gen], [LEVEL] -21 dBm, [FREQ] 10 MHz. All modulation and noise measurements should be switched OFF.
- (3) Check that the power meter indicates $-21 \text{ dBm} \pm 2 \text{ dB}$.
- (4) Select N-type output/N-type input mode and check that the level measured is $-21 \text{ dBm} \pm 2 \text{ dB}$.
- (5) Press RF IN/OUT [SELECT] until the mode returns to N-type output/antenna input.
- (6) Repeat steps 3 to 5 for 100 MHz and then in 100 MHz steps up to and including 1000 MHz.

ALC linearity

- (1) Refer to Results table 5-3 on page 5-32. Connect the sensor to the N-type output socket, as shown in Fig. 5-2.
- (2) Set the UUT to [RF Gen], [LEVEL] -21 dBm, [Δ INC] 1 dB, [FREQ] 10 MHz.
- (3) Increment the RF output of the UUT in 1 dB steps down to -38 dBm, ensuring that the indication on the power meter is within ± 2 dB of each level set.
- (4) Return the UUT RF level to -21 dBm.
- (5) Set the UUT carrier frequency to 500 MHz and repeat step 3. Refer to Results table 5-4 on page 5-32.
- (6) Set the UUT carrier frequency to 1 GHz, return the level to -21 dBm and repeat step 3. Refer to Results table 5-5 on page 5-33.

BNC output mode

No claim is made on the output level accuracy of the BNC socket. The following is a functional check to ensure correct internal operation.

- (1) Connect the 6920 sensor to the BNC output, as shown in Fig. 5-2.
- (2) Set the UUT to [Rx TEST], RF IN/OUT [SELECT] BNC output, [RF Gen], [LEVEL] -21 dBm, [FREQ] 10 MHz. All modulation and noise measurements should be switched OFF.
- (3) Check that the power meter indicates -21 dBm \pm 4 dB.
- (4) Repeat step 3 for 100 MHz and then in 100 MHz steps up to and including 1000 MHz.

Attenuator accuracy

The following test will confirm that the attenuator performs to the published performance specification. In the event of the receiver not being available, an alternative method to functionally test the attenuator is also suggested.

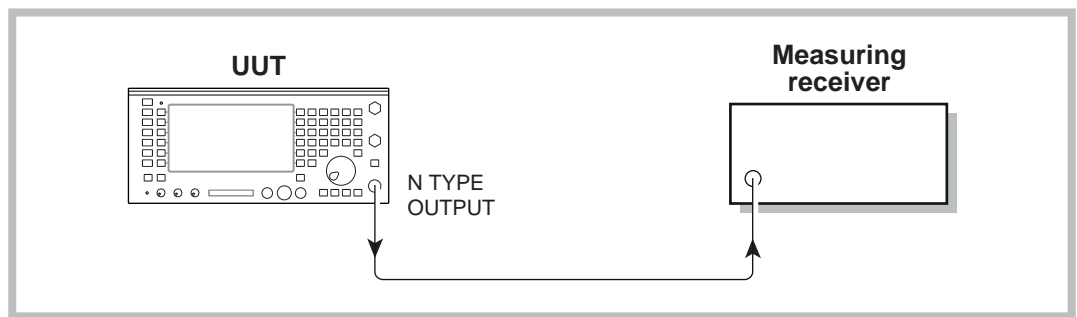

C2582

Fig. 5-3 RF level set up

- (1) Connect the test equipment as shown in Fig. 5-3.
- (2) Set the UUT to [RF Gen], [LEVEL], -21 dBm, [FREQ] 2.5 MHz.
- (3) Tune the receiver to the frequency set on the UUT RF Generator and measure the RF level.
- (4) Decrement the output of the UUT in 10 dB steps down to an RF level of -121 dBm, measuring the RF level at each step.
- (5) Repeat steps 2 to 4 for frequencies of 500 and 1000 MHz.

Alternative attenuator functional check

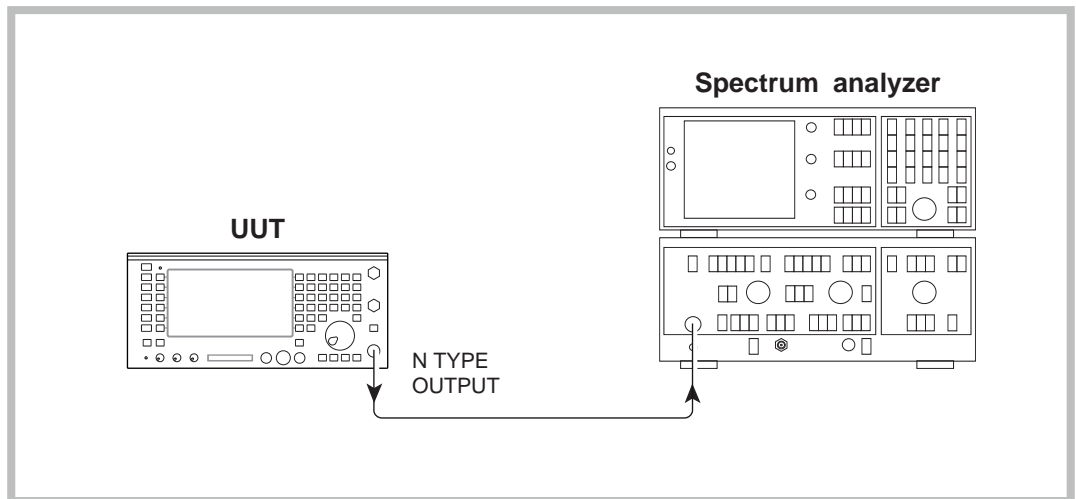

C2583

Fig. 5-4 Attenuator functional check

- (1) Connect the test equipment as shown in Fig. 5-4.
- (2) Set the UUT to [Rx TEST], RF IN/OUT [SELECT] N-type output, [RF Gen], [LEVEL] -27 dBm, [Δ INC] 10 dB, [FREQ] 251 MHz. All modulation and noise measurements should be switched OFF.
- (3) Tune the Spectrum analyzer to the signal from the UUT. Using the UUT increment level down arrow key, reduce the level of the UUT output in 10 dB steps down to -127 dBm. At each 10 dB step ensure the level on the analyzer drops accordingly

Spectral purity

Harmonics, spurious, RF carrier leakage, residual FM

Specification

Carrier range:	400 kHz to 1.05 GHz
Harmonics:	Better than -25 DBE
Spurious signals	Better than -30 dBc
Residual FM	Less than 12 Hz RMS (0.3 to 3.4 kHz)

Test equipment

Description	Minimum specification	Example
Spectrum analyzer	400 kHz to 3 GHz noise floor better than -127 dBm at 500 MHz	IFR 2383
Low-noise FM demodulator	Residual FM to be less than 2 Hz up to 1 GHz	IFR 2305 + IFR 2041

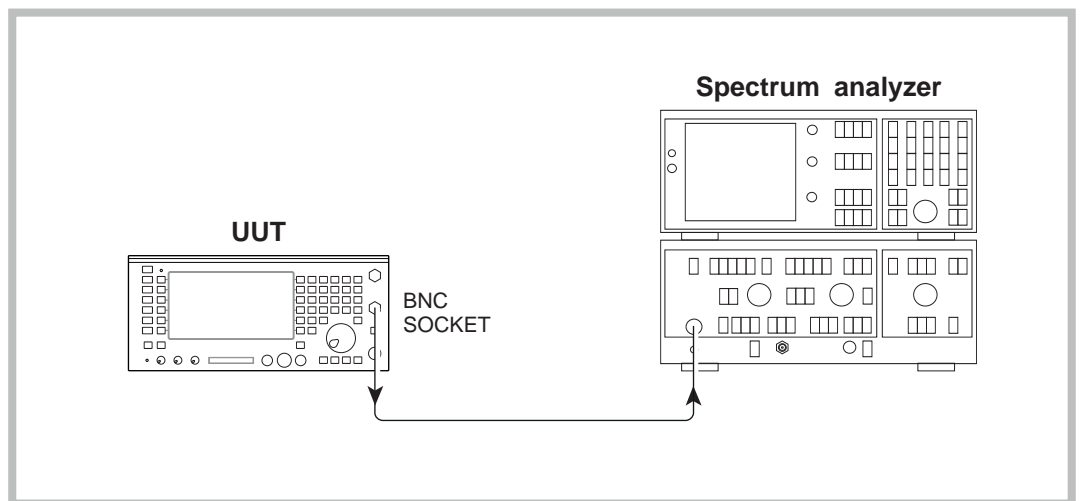

C2584

Fig. 5-5 Carrier harmonics & spurious check

- (1) Refer to Results table 5-6 on page 5-33. Connect the Spectrum analyzer to the BNC socket on the UUT, as shown in Fig. 5-5.
- (2) Set the UUT to [Rx TEST], RF IN/OUT [SELECT] BNC output, [RF Gen], [LEVEL] 0 dBm, [FREQ] 0.4 MHz. All modulation and noise measurements should be switched OFF.
- (3) Tune the Spectrum analyzer to view the harmonics shown in the second harmonic and third harmonic column of Results table 5-6, checking that they are within the above specification.
- (4) Repeat steps (2) and (3) for the remaining frequencies shown in the table.
- (5) Refer to Results table 5-7 on page 5-33. Set the UUT to [Rx TEST], RF IN/OUT [SELECT] BNC output, [RF Gen], [LEVEL] 0 dBm, [FREQ] 0.4 MHz.
- (6) Use the Spectrum analyzer to check that any spurious signals are < -50 dBc. Repeat for UUT carrier frequencies of 500 MHz and 1000 MHz. Repeat for a UUT carrier frequency of 650 MHz checking that any spurious signals are < -50 dBc.

ACCEPTANCE TESTING

- (7) To confirm the low residual FM of the UUT, the use of an extremely low-noise FM demodulator is necessary; this is achieved by using the IFR 2041 Low-noise signal generator as the local oscillator for the 2305. Connect the test equipment as shown in Fig. 5-6
- (8) Refer to Results table 5-8 on page 5-34. Set the UUT to [Rx TEST], RF IN/OUT [SELECT] BNC output, [RF Gen], [LEVEL] 0 dBm, [FREQ], 1000 MHz. Switch all modulation generators and noise measurements off.
- (9) Set the signal generator into low noise mode 1 and to provide a signal of 55.63889 MHz at 0 dBm.
- (10) Set the Modulation meter to measure FM in a 300 Hz to 3.4 kHz bandwidth with noise averaging on. Select external LO by pressing **FREQ TUNE**, 0, **ENTER**. External LO should now appear in the top left of the modulation window display and the frequency window should display the IF frequency of 1.5 MHz \pm 150 kHz. Check that the residual FM displayed in the modulation window is less than 12 Hz.
- (11) Set the UUT RF Generator and the local oscillator to the frequencies shown in Results table 5-8, confirming that the residual FM indicated on the Modulation meter is within the limits shown in the right hand column.
- (12) MHz can be measured with the 2305 in its normal mode of operation; e.g. press [*Auto Tune*] to switch off the external LO mode.

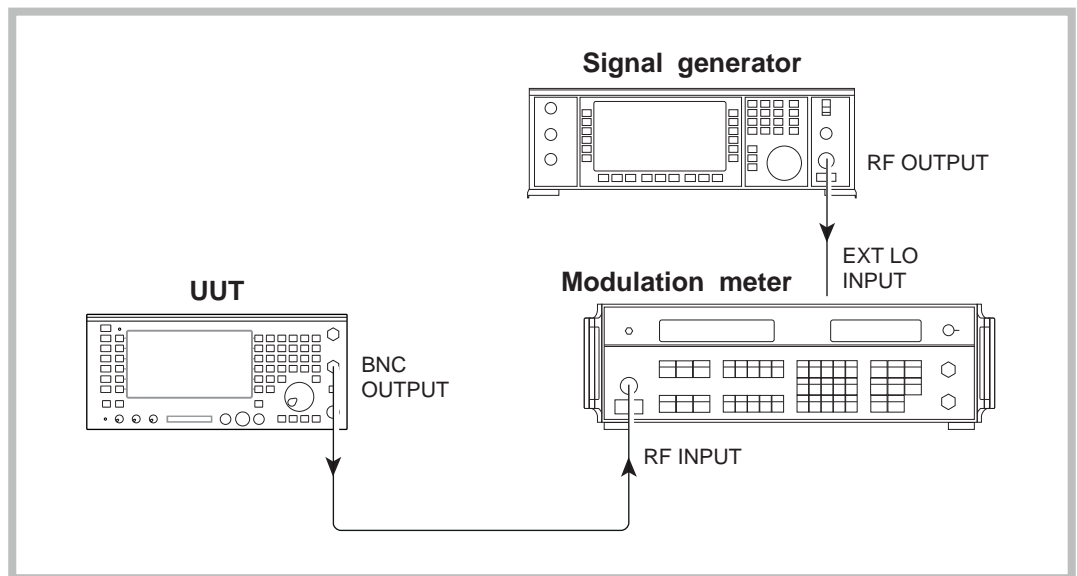

C2586

Fig. 5-6 Residual FM checks

Amplitude modulation

Specification

Carrier range:	400 kHz to 1.05 GHz
Resolution:	1%
Accuracy	$\pm 5\%$ of setting ± 1 digit for modulation frequency 1 kHz, 50%

Test equipment

Description	Minimum specification	Example
Modulation meter	RF I/P 500 kHz to 400 MHz AM Measurement accuracy up to 85% depth:- $\pm 1\%$ of reading at 1 kHz mod rate	IFR 2305

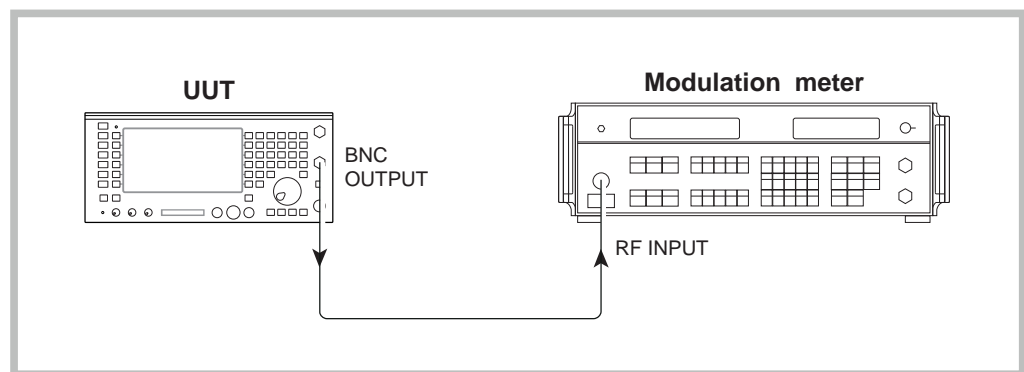

C2587

Fig. 5-7 Internal AM accuracy checks

- (1) Refer to Results table 5-9 on page 5-34. Connect the test equipment as shown in Fig. 5-7 (BNC output socket on UUT).
- (2) Set the UUT to [Rx TEST], RF IN/OUT [SELECT] BNC output, [RF Gen], [LEVEL] 0 dBm, [FREQ] 1.5 MHz, [Mod Gen], [Gen 2], [FREQ] 1 kHz, [LEVEL] 50%.
- (3) Set the Modulation meter to monitor AM in a 0.3 to 3.4 kHz bandwidth.
- (4) Check the Modulation meter for a reading within $\pm 7\%$ of setting ± 1 digit.
- (5) Repeat step 4, but with the UUT RF generator set to each of the remaining carrier frequencies shown in the Results table 5-9 on page 5-34.

Frequency modulation

Specification

Carrier range	400 kHz to 1.05 GHz
Accuracy†	$\pm 7\% \pm 10$ Hz at 1 kHz modulating frequency

† At low modulation levels the residual AM/FM may become significant

Test equipment

Description	Minimum specification	Example
Modulation meter	RF I/P 500 kHz to 1.05 Ghz. FM measurement accuracy $\pm 0.5\%$ of reading ± 1 least significant digit at 1 kHz mod rate for deviation > 5 kHz.	IFR 2305

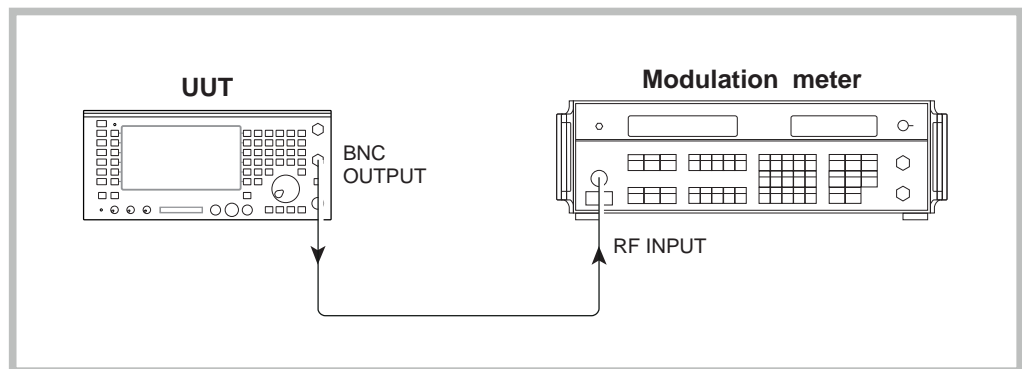

C2587

Fig. 5-8 Internal FM accuracy checks

- (1) Refer to Results table 5-10 on page 5-34. Connect the test equipment as shown in Fig. 5-8 (BNC output on UUT).
- (2) Set the UUT to [Rx TEST], RF IN/OUT [SELECT] BNC output, [RF Gen], [LEVEL] 0 dBm, [FREQ] 0.5 MHz, [Mod Gen], [Gen 2], [LEVEL] 10 kHz, [FREQ] 1 kHz. All other modulation generators and noise measurements should be switched OFF.
- (3) Set the Modulation meter to monitor FM in a 50 Hz to 15 kHz bandwidth, Noise averaging on.
- (4) Check the Modulation meter indicates a reading within $\pm 7\% \pm 10$ Hz of the deviation set. Repeat with the UUT set to each of the remaining carrier frequencies shown in the Results table 5-10.
- (5) Refer to Results table 5-11 on page 5-35. Set the UUT to [RF Gen], [FREQ] 600 MHz, [Mod Gen], [Gen 2], [LEVEL] 75 kHz.
- (6) Check the modulation meter indicates a reading within $\pm 7\% \pm 10$ Hz of the deviation set. Repeat with the UUT set to provide deviations of 50 kHz, 25 kHz and 5 kHz.

AF output tests

Audio generator output level

Specification

Level range:	0.1 mV to 4 V RMS
Accuracy:	$\pm 5\%$ \pm resolution 50 Hz to 15 kHz

Test equipment

Description	Minimum specification	Example
DVM	1 % accuracy 50 Hz to 15 kHz	Solatron 7150+



C2588

Fig. 5-9 Audio generator level accuracy checks

- (1) Refer to Results table 5-12 on page 5-35. Connect the test equipment as shown in Fig. 5-9, connecting the UUT AF Gen output socket to the DVM voltmeter input terminals.
- (2) Set the DVM to measure Volts AC RMS.
- (3) Set the UUT to [AF TEST], [Audio Gen] 1 [FREQ] 1 kHz, [LEVEL] 4 V. Audio Gen 1 should be set to Sinewave and Audio Gen 2 should be OFF. Check that the DVM reads the level set $\pm 5\% \pm 1$ mV. Repeat with frequencies of 50 Hz, 150 Hz, 500 Hz, 2 kHz, 5 kHz, 10 kHz and 15 kHz in turn, checking that the DVM reads the level set $\pm 5\% \pm 1$ mV.
- (4) Set the UUT to [AF Gen 1], [FREQ] 1 kHz, [LEVEL] 20.0 mV. Repeat with the level set to 400 mV. Check that for each level the DVM reads the level set $\pm 5\% \pm 0.1$ mV. Repeat with the level set, in turn, to 1000 mV, 2000 mV and 3000 mV, and check that in each case the DVM reads the level set $\pm 5\% \pm 1$ mV.
- (5) Refer to Results table 5-13 on page 5-35. Repeat the above checks for AF Gen 2 with AF Gen 1 switched OFF.

Audio generator distortion

Specification

Distortion:	Less than 0.5% at 1 kHz
	Less than 1% from 50 Hz to 15 kHz

Test equipment

Description	Minimum specification	Example
Distortion analyzer	Capable of measuring distortion from 1 kHz to 15 kHz down to 0.1%.	IFR 2965 or HP8903B

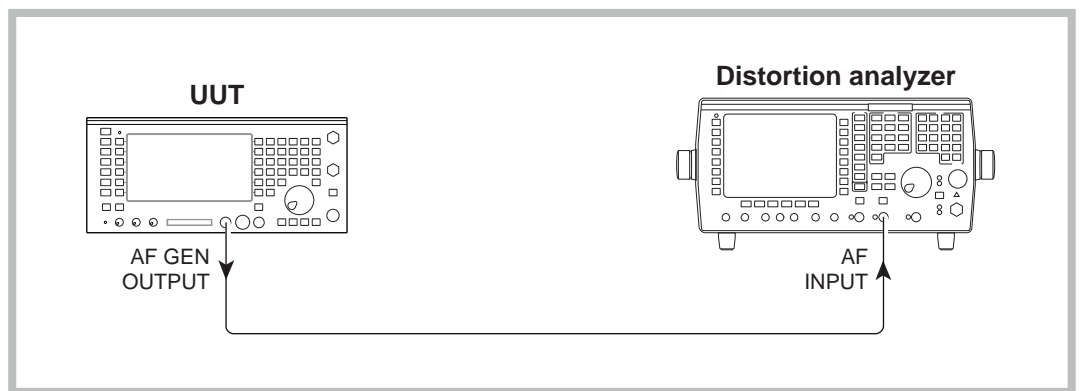

C2589

Fig. 5-10 Audio generator signal purity checks

- (1) Refer to Results table 5-14 on page 5-36. Connect the UUT AF GEN output to the AF input of the distortion meter, as shown in Fig. 5-10.
- (2) Set the UUT to [AF TEST], [Audio Gen], [FREQ] 1 kHz, [LEVEL] 4 V. Audio Gen 1 should be set to sinewave and Audio Gen 2 should be OFF.
- (3) Set the Distortion meter to measure distortion at 1 kHz in a 0.3 to 3.4 kHz bandwidth.
- (4) Check that the distortion indicated is less than 0.5%.
- (5) Repeat step (4) with AF Gen 1 level set to 100 mV.
- (6) Set the Distortion meter to measure distortion in a 20 kHz Lowpass bandwidth.
- (7) Set AF Gen 1 to provide 4 V at a frequency of 2 kHz. Check that the distortion indicated on the Distortion meter is less than 1%. (If a 2965 is being used, see the Operating Manual for instructions on setting distortion measurement to different frequencies.) Repeat at 5 kHz. Set the lowpass bandwidth on the distortion meter to NONE and repeat with AF Gen 1 set to provide 15 kHz.
- (8) Refer to Results table 5-15 on page 5-36. Repeat the above procedure, except this time with AF Gen 1 switched OFF and AF Gen 2 ON.

Audio generator frequency

This is a functional check only. The Audio generator frequency is derived digitally and provided that the hardware is operational its accuracy will be maintained. The instrument's internal reference frequency is checked elsewhere. This check is listed at this point as it is one of the AF generator tests, but it should be carried out after the UUT audio frequency meter has been checked (see *AF input tests; AF frequency meter*).

Specification

Frequency accuracy: 0.01 Hz □ frequency standard □ 180 Hz
 0.1 Hz ± frequency standard >180 Hz

- (1) *Refer to Results table 5-16 on page 5-36.* Connect the UUT AF GEN OUT socket to the UUT AF INPUT socket.
- (2) Set the UUT to [AF TEST], [AF Filter], [50 kHz LP] to set the Audio Input filter to 50 kHz Lowpass.
- (3) Set [Audio Gen], [LEVEL] 1 V, [FREQ] 10 Hz. Audio generator 2 should be switched OFF. Check that the frequency indicated on the UUT audio counter is within the limits shown in *Results table 5-16*. Repeat with the remaining frequencies shown in the table.
- (4) *Refer to Results table 5-17 on page 5-37.* Repeat checks with AF GEN 2.

AF input tests

Audio frequency meter

This test confirms the accuracy of the audio counter hardware. Overall accuracy is governed by the instrument reference frequency. The reference is checked independently elsewhere. **Note:** If the LF generator is not available then the Audio generator frequency check will confirm that the audio frequency meter is functional.

Specification

Frequency range:	20 Hz to 50 kHz
Resolution:	0.1 Hz, less than 10 kHz 1 Hz, at 10 kHz and above
Accuracy:	As frequency standard ± 1 digit \pm resolution
Sensitivity:	50 mV

Test equipment

Description	Minimum specification	Example
LF generator	20 Hz to 20 kHz frequency external standard In/Out	HP 3325B
DVM	1 % accuracy 20 Hz to 20 kHz	Solatron 7150+

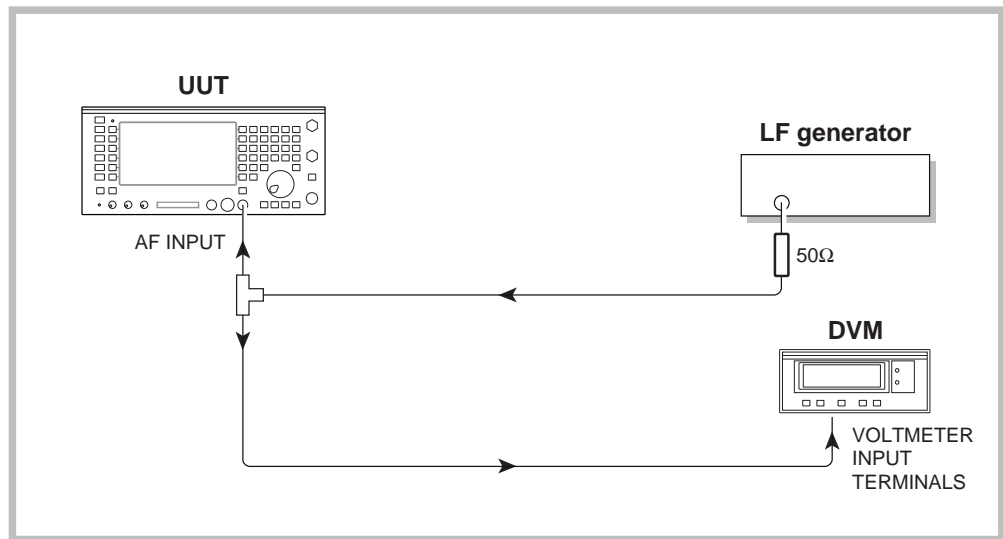

C2590

Fig. 5-11 Audio frequency meter check

- (1) Refer to Results table 5-18 on page 5-37. Connect the equipment as shown in Fig. 5-11 connecting to the UUT AF input socket. The frequency standards of the UUT and LF generator should be locked together. The 50 Ω load is in circuit because the LF generator used indicates level across 50 Ω .
- (2) Press [HELP/SETUP], [Setup], [AF Filters], [Factory Preset], [Return], [Return], [Return]. Set the UUT to [AF TEST] press [AF Filter], [50 kHz LP] to set the Audio Input filter to 50 kHz Low-pass.
- (3) Set the DVM to monitor Volts AC.
- (4) Set the LF generator to the first frequency shown in the Results table 5-18, and adjust the level for an indication of 50 mV RMS on the DVM. Check that the frequency indicated on the UUT audio counter is within the limits shown. Repeat for the remaining frequencies in the table.

Audio voltmeter

Specification

Level accuracy:	$\pm 3\% \pm 3 \text{ mV} \pm \text{resolution}$ 20 Hz to 50 kHz, AC $\pm 1\% \pm 50 \text{ mV} \pm \text{resolution}$, DC
Resolution:	1 mV or 1% of reading

Test equipment

Description	Minimum specification	Example
LF generator	50 Hz to 50 kHz 30 mV to 5 V RMS	IFR 2965
DC power supply	0 to 50 V	
DVM	DC measurement and AC measurement 20 Hz to 50 kHz	Solatron 7150+

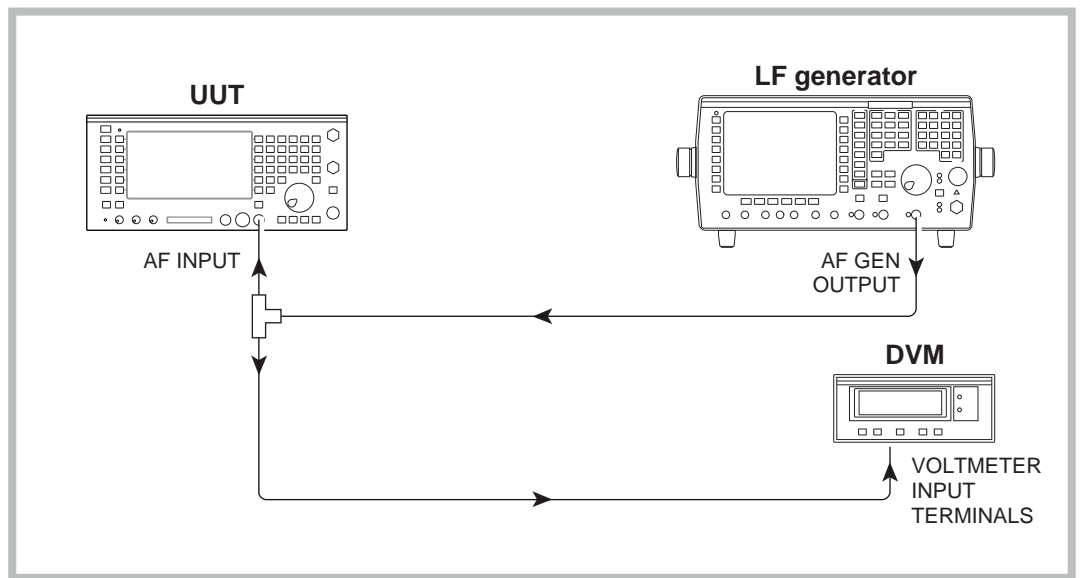

C2591

Fig. 5-12 Audio voltmeter level accuracy checks

- (1) Refer to Results table 5-19 on page 5-38. Connect the equipment as shown in Fig. 5-12, connecting the LF generator output to the UUT AF input and via a T-piece to a DVM.
- (2) Press [HELP/SETUP], [Setup], [AF Filters], [Factory Preset], [Return], [Return], [Return]. Set the UUT to [AF TEST] press [AF Filter], [50 kHz LP] to set the Audio Input filter to 50 kHz Low-pass. Press AC/DC coupling until AC coupled is displayed.
- (3) Set the DVM to measure Volts AC and the LF generator to frequency 1 kHz, level 30 mV RMS (adjust until the DVM indicates as close to 30 mV as possible). Check that the level indicated on the UUT voltmeter is within $\pm 3\% \pm 3 \text{ mV} \pm \text{resolution}$ of the level indicated on the DVM.
- (4) Repeat step 3 with LF generator levels of 200 mV, 0.4 V, 0.8 V, 2 V, 4.5 V.

- (5) This step is a functional check only and confirms that the audio filters switch in correctly with minimal insertion loss. Press [HELP/SETUP], [Setup], [AF Filters], [Factory Preset], [Return], [Return], [Return].
 - Set the UUT AF filter to 15 kHz LP and check that the UUT voltmeter indicates within $\pm 6\% \pm 3 \text{ mV} \pm$ resolution of the level measured with the 50 kHz LP.
 - Repeat with the 300 to 3.4 kHz BP filter.
 - Repeat with the 50 to 15.0 kHz BP filter.
 - Set the LF generator to 100 Hz and set the UUT filter back to 50 kHz LP. Note the reading and then set the UUT filter to 300 Hz LP. Check that the UUT voltmeter indicates within $\pm 6\% \pm 3 \text{ mV} \pm$ resolution of the level measured with the 50 kHz LP.
- (6) Set the UUT AF filter to 50 kHz LP.
- (7) Set the LF generator to frequency 50 Hz level 1 V RMS (adjust until DVM indicates as close to 1 V as possible). Check that the level indicated on the UUT voltmeter is within $\pm 3\% \pm 3 \text{ mV} \pm$ resolution of the level indicated on the DVM.
- (8) Repeat step 7 with LF generator frequencies of 100 Hz, 500 Hz, 10 kHz, 30 kHz and 50 kHz.
- (9) Set the UUT AF input to DC coupled and substitute the LF generator with the DC power supply. Set the external DVM to monitor DC volts.
- (10) Set the DC supply to 25 V (adjust until DVM indicates as close to 25 V as possible). Check that the level indicated on the UUT voltmeter is within $\pm 1\% \pm 50 \text{ mV} \pm$ resolution of the level indicated on the DVM. Repeat this step with the DC supply set to 50 V.

AF distortion & SINAD meter

Specification

Frequency range:	1 kHz
Distortion meter accuracy	$\pm 5\%$ of reading $\pm 0.5\%$ distortion
SINAD meter accuracy	$\pm 1 \text{ dB}$

- (1) Refer to Results table 5-20 on page 5-38. Connect UUT AF INPUT to UUT AF GEN OUT.
- (2) Set the UUT to [AF TEST], [Audio Gen], [FREQ] 1 kHz, [LEVEL] 1 V. Press [Gen 1/Gen2] to select AF Gen 2, then [FREQ] 400 Hz, [LEVEL] 20 mV, [ON]. This should cause AF Gen 1 to be set to 1 kHz, 1 V, and AF Gen 2 to 400 Hz, 20 mV. If these values are not set, make the required adjustments to achieve them.
- (3) Press [Return], [Audio Meter], [DIST/S-N], [DIST'N] to switch the UUT distortion meter on.
- (4) Check that the distortion meter reads between 1.4 and 2.6% distortion, i.e. 2% distortion $\pm 5\%$ of reading $\pm 0.5\%$ distortion.
- (5) Set AF Gen 2 level to 250 mV.
- (6) Select AF Gen 1 level and adjust until the UUT voltmeter reads 1.00 V.
- (7) Check that the distortion meter reads between 23.2 and 26.8% distortion, i.e. 25% distortion $\pm 5\%$ of reading $\pm 0.5\%$ distortion.
- (8) Press [Return], [DIST/S-N], [Sinad] to switch the UUT SINAD meter on.
- (9) Check that the SINAD meter reads 12 dB $\pm 1 \text{ dB}$.

RF input tests

Modulation analyzer - FM

Specification

Frequency range:	400 kHz to 1.05 GHz
Modulation frequency range:	10 Hz to 15 kHz
Deviation range:	0 to 75 kHz
Resolution:	10 Hz below 2 kHz deviation 1% above 2 kHz deviation
Accuracy (see Note 1)	$\pm 5\% \pm$ resolution at 1 kHz modulation frequency
Demodulation scope accuracy	$\pm 10\%$
Demodulation output socket	200 mV peak to peak $\pm 10\%$ per 1 kHz deviation
Demodulation filters	300 Hz LP, 3 kHz LP, 0.3 to 3.4 kHz BP, 15 kHz LP, 750 μ s de-emphasis
Residual FM:	Less than 30 Hz (300 Hz to 3.4 kHz)

Note 1:

At low modulation levels, the residual AM/FM may become significant.

Test equipment

Description	Minimum specification	Example
RF signal generator	5.5 MHz to 1 GHz. Deviation 0 to 75 kHz. Modulation rate 1 kHz.	IFR 2041
Modulation meter	RF I/P 5.5 MHz to 1 GHz. FM measurement accuracy $\pm 0.5\%$ of reading ± 1 least significant digit at 1 kHz mod rate for deviation > 5 kHz.	IFR 2305
Power splitter	6 dB 50 Ω 5.5 MHz to 1 GHz	WEINSCHEL 1870A
DVM	1 % accuracy 1 kHz	Solatron 7150+

- (1) Refer to Results table 5-21 on page 5-38. Connect the equipment as shown in Fig. 5-13, connecting the incoming signal to the antenna input socket of the UUT.
- (2) Set the Modulation meter to monitor FM in a 50 Hz to 15 kHz bandwidth, noise averaging on.
- (3) Set the UUT to [Tx TEST], RF IN/OUT [SELECT] antenna BNC input socket. From the power up default, the instrument should already be set to demodulate FM with an IF filter of 30 kHz and AF filter of 0.3 to 3.4 kHz selected. Check that this is the case and select if necessary.
- (4) On the UUT, set [Tx Freq] 5.5 MHz. Set the RF signal generator to provide a signal of 5.5 MHz with 20 kHz deviation at 1 kHz modulation rate. Set the RF level to 6 dBm. (If a 2041 is being used then it should be set to normal noise mode.)

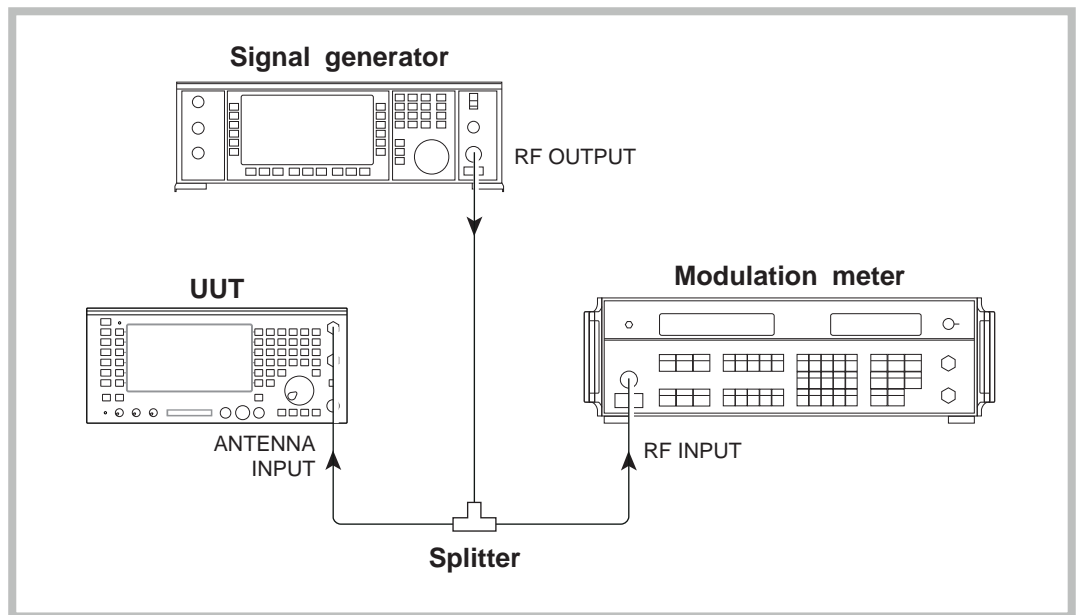

C2592

Fig. 5-13 Modulation meter FM

- (5) Check that the deviation level indicated on the UUT is within $\pm 5\% \pm$ resolution of the deviation indicated on the external Modulation meter.
- (6) Repeat steps 4 and 5 for RF carrier frequencies of 500 MHz and 1000 MHz.
- (7) Refer to Results table 5-22 on page 5-39. On the UUT select an AF filter of 0.3 to 3.4 kHz and an IF filter of 3 kHz.
- (8) Set the external Modulation meter bandwidth to 50 Hz to 15 kHz.
- (9) Set the RF signal generator modulation rate to 1 kHz and set 250 Hz deviation.
- (10) Check that the deviation level indicated on the UUT is within $\pm 5\% \pm$ UUT resolution of the deviation indicated on the Modulation meter.
- (11) On the UUT select an IF filter of 30 kHz. Set the RF signal generator to provide a deviation of 10 kHz and check that the deviation level indicated on the UUT is within $\pm 5\% \pm$ UUT resolution of the deviation indicated on the Modulation meter.
- (12) On the UUT select an IF filter of 300 kHz. Set the RF signal generator to provide a deviation of 50 kHz and check that the deviation level indicated on the UUT is within $\pm 5\% \pm$ UUT resolution of the deviation indicated on the Modulation meter. Repeat at 75 kHz.
- (13) Refer to Results table 5-23 on page 5-39. Select the UUT demodulation oscilloscope by pressing [Return], [Scope/Bar], [Scope]. Using the oscilloscope horizontal and vertical soft keys select a vertical scale of 25 kHz/div and a horizontal scale of 200 μ s/div.
- (14) Adjust the deviation level from the RF signal generator until the 1 kHz trace on the oscilloscope occupies the full six deviations.
- (15) Check that the deviation indicated on the external Modulation meter is between 67.5 and 82.5 kHz.
- (16) Adjust the deviation level from the RF signal generator until the external Modulation meter reads 75.0 kHz deviation. Leave all settings unaltered while carrying out step 17.
- (17) Refer to Results table 5-24 on page 5-39. Connect the DEMOD OUT socket on the rear of the UUT to the DVM. Set the DVM to monitor Volts AC and check that the level indicated is between 4.77 V and 5.83 V.
- (18) Set the RF signal generator modulation rate to 2 kHz.
- (19) On the UUT press [Return], [Mod Meter], [Deemph] to switch de-emphasis on.

ACCEPTANCE TESTING

- (20) Check that the deviation reading on the UUT drops by approximately half, i.e. to 37.5 kHz. (functional check).
- (21) Press [*Deemph*] to switch the de-emphasis filter off and then [*Return*], [*Scope/Bar*], [*Bar Chart*], [*Return*], to switch the oscilloscope off.
- (22) Remove the splitter and Modulation meter and connect the RF signal generator directly to the UUT antenna input.
- (23) Set the UUT to [Tx FREQ] 300 MHz and set the RF signal generator to provide a signal of 300 MHz with 5 kHz deviation at 1 kHz modulation rate. (The 2041 should be set to low noise mode.)
- (24) Note the voltage reading on the DVM connected to the DEMOD OUT socket of the UUT (*Reading 1*).
- (25) Switch the RF signal generator modulation off and note the reading on the DVM (*Reading 2*).
- (26) Calculate the residual FM as shown below and check that it indicates 35 Hz or less (functional check only).

$$(\textit{Reading 2} \div \textit{Reading 1}) \times 5000$$

Modulation analyzer - AM

Specification

Frequency range:	400 kHz to 1.05 GHz
Modulation frequency range:	10 Hz to 15 kHz
AM depth range:	0 to 99% (manually tuned)
Resolution:	1% AM
Accuracy (see Note 1)	±5% ±1 digit at 1 kHz ±8.5% ±1 digit, 50 Hz to 10 kHz
Residual AM:	Less than 1% (0.3 to 3.4 kHz)

Note:

(1) At low modulation levels, the residual AM/FM may become significant.

Test equipment

Description	Minimum specification	Example
RF signal generator	500 kHz to 1 GHz. AM depth 0 to 95%. Modulation rate 30 Hz to 15 kHz.	IFR 2041
Modulation meter	RF I/P 500 kHz to 1 GHz. AM measurement accuracy ±1% of reading ±1 least significant digit at 1 kHz mod rate for depths up to 95%.	IFR 2305
Power splitter	6 dB 50 Ω 500 kHz to 1 GHz.	WEINSCHEL 1870A

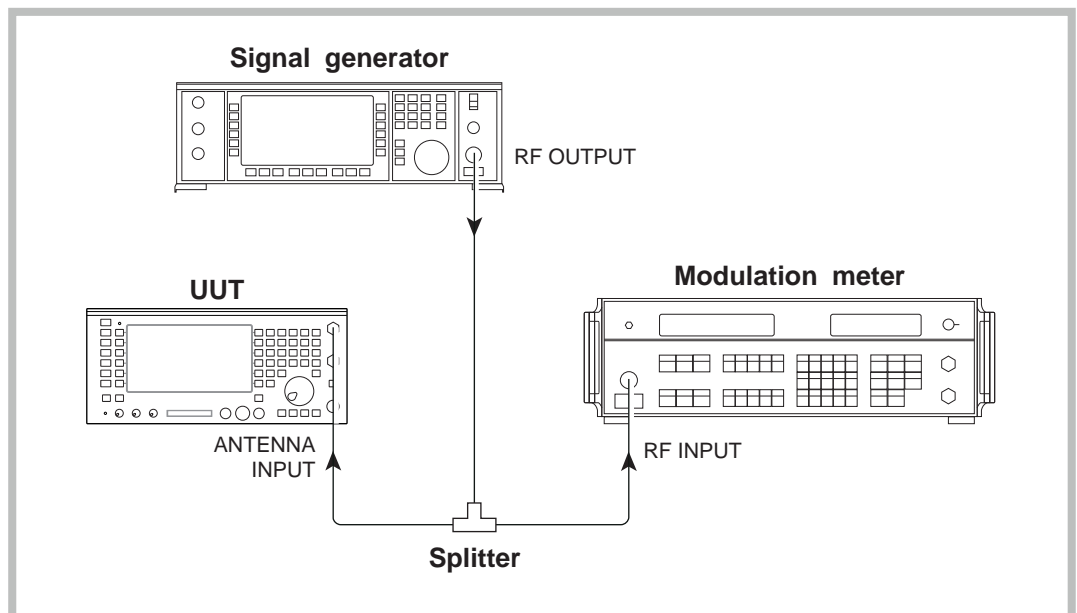

C2592

Fig. 5-14 Modulation analyzer - AM

- (1) Refer to Results table 5-25 on page 5-39. Connect the equipment as shown in Fig. 5-14, connecting the incoming signal to the antenna input socket of the UUT.

ACCEPTANCE TESTING

- (2) Set the Modulation meter to monitor AM in a 50 Hz to 15 kHz bandwidth, Noise averaging on. Press [HELP/SETUP], [Setup], [AF Filters], [Factory Preset], [Return], [Return], [Return].
- (3) Set the UUT to [Tx TEST], RF IN/OUT [SELECT] antenna input socket, [Mod Meter]. Press the [AM/FM] soft key to set the UUT to demodulate AM. From the power up default, the instrument should already have an IF filter of 30 kHz and AF filter of 0.3 to 3.4 kHz selected. Check that this is the case and select if necessary.
- (4) Tune the UUT to 500 kHz by pressing [Return], [Tx Freq] 500 kHz. Set the RF signal generator to provide a signal of 500 kHz with 70% AM at 1 kHz modulation rate. Set the RF level to 6 dBm. (If a 2041 is being used, it should be set to normal noise mode.)
- (5) Check that the AM depth indicated on the UUT is within $\pm 5\%$ of reading ± 1 digit of the depth indicated on the external Modulation meter.
- (6) Repeat steps 4 and 5 for RF carrier frequencies of 500 MHz and 1050 MHz.
- (7) Refer to Results table 5-26 on page 5-39. On the UUT, select the 300 Hz lowpass filter and TX FREQ 100 MHz.
- (8) Set the external modulation monitor bandwidth to 30 Hz to 50 kHz.
- (9) Set the RF signal generator to provide a signal of 100 MHz with 70% depth at 50 Hz modulation rate. Check that the modulation depth indicated on the UUT is within $\pm 8.5\%$ of reading ± 1 digit of the depth indicated on the Modulation meter.
- (10) On the UUT select the 50 kHz lowpass AF filter and the 300 kHz IF filter. Change the modulation rate on the RF signal generator to 10 kHz and check that the modulation depth indicated on the UUT is within $\pm 8.5\%$ of rdg ± 1 digit, of the depth indicated on the Modulation meter.
- (11) Refer to Results table 5-27 on page 5-40. When finished, select the 0.3 to 3.4 kHz AF filter on both the UUT and the external Modulation meter. Select the 30 kHz IF filter on the UUT.
- (12) Set the RF signal generator modulation rate to 1 kHz and set 5% AM depth.
- (13) Check that the AM depth indicated on the UUT is within $\pm 5\%$ of reading ± 1 digit of the depth indicated on the Modulation meter. Repeat with the RF signal generator set to provide depths of 20%, 50%, 80%, and 95%.
- (14) Refer to Results table 5-28 on page 5-40. Select the Oscilloscope on the UUT. Set a timebase of 500us/div and a vertical scale of 10%/div.
- (15) Set the RF signal generator to provide 60% AM, adjusting this level until the demodulated signal on the display occupies the full six divisions. Check that the modulation indicated on the external Modulation meter is 60% $\pm 10\%$.
- (16) Remove the splitter and Modulation meter and connect the RF signal generator directly to the UUT BNC input.

RF frequency meter

Specification

Frequency range:	400 kHz to 1.05 GHz
Resolution:	0.1 Hz, 1 Hz or 10 Hz selectable
Accuracy	As frequency standard \pm resolution
Sensitivity autotuned	5 mW (N-type), 0.05 mW (antenna port)
Sensitivity manual tuned	-34 dBm (N-type), -60 dBm (antenna port)

Test equipment

Description	Minimum specification	Example
RF signal generator	400 kHz to 1.05 GHz	IFR 2965 or IFR 2041
RF power meter	± 0.1 dB from 10 MHz to 1 GHz	IFR 6960/A/B + 6920 sensor

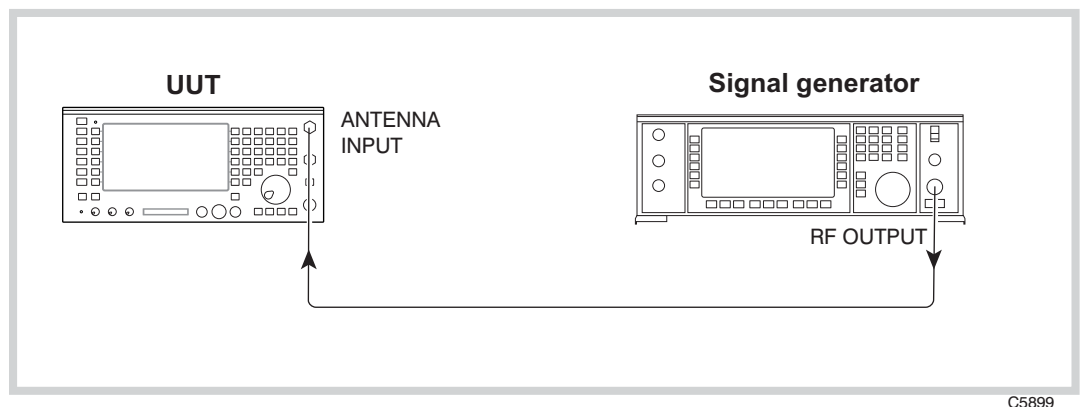

C5899

Fig. 5-15 RF frequency meter

- (1) Refer to Results table 5-29 on page 5-41. Connect the equipment as shown in Fig. 5-15, connecting the incoming signal to the antenna input socket of the UUT. Lock the 2948 external standard input to the external standard output of the signal generator.
- (2) Set the UUT to [Tx TEST], RF IN/OUT [SELECT] antenna BNC input socket. Press [HELP/SETUP], [Setup], and toggle RF counter resolution until 1 Hz is displayed in reverse field, then press [Return], [Return] to get back to the TX test display.
- (3) On the UUT, press [Tx Freq] 10 MHz. Set the RF signal generator to provide a signal of 10 MHz at an RF level of -60 dBm. Check this level by removing the RF test signal connection from the UUT and applying it to the RF power meter. Adjust the level if necessary, then reconnect the UUT.
- (4) Check that the offset indicated on the UUT is 0 Hz \pm 1 Hz.
- (5) Repeat steps 3 & 4 for frequencies of 500 MHz and 1.05 GHz.
- (6) Refer to Results table 5-30 on page 5-41. Press the [Auto Tune] key on the UUT.
- (7) Set the RF signal generator to provide a signal of 1000 MHz at a level of -13 dBm (check and set this level on the power meter). Check that the UUT autotunes to the incoming frequency and the Frequency counter indicates the frequency \pm 1 Hz. Repeat at 500 MHz and 10 MHz.

ACCEPTANCE TESTING

- (8) Disconnect the external reference from the UUT and connect an external reference with an accuracy of 1 part in 10^9 or better to the RF signal generator.
- (9) *Refer to Results table 5-31 on page 5-41.* Set the RF signal generator to provide a frequency of 1000 MHz at a level of 0 dBm.
- (10) Check that the UUT indicates a frequency between 999.999750 MHz and 1000.000250 MHz. The test limits in this step are for guidance and assume that the internal frequency standard has been recently adjusted. Ageing and stability have to be considered when establishing the *real* test limits.

RF spectrum analyzer

Specification

Frequency range:	400 kHz to 1.0 GHz
Resolution bandwidth	300 Hz, 3, 30, 300 kHz, 3 MHz
Display dynamic range:	80 dB
Noise floor	Typically 75 dB below top of screen
On screen linearity:	Typically ± 2 dB \pm resolution (10 dB/div) (10 dB above the noise floor)
Resolution:	0.1 dB on 2 dB/ division 0.5 dB on 10 dB/ division
Level flatness	± 2 dB \pm resolution (10 dB/division)

Test equipment

Description	Minimum specification	Example
RF signal generator	100 kHz to 1 GHz. Level accuracy ± 0.85 dB	IFR 2041
RF power meter	± 0.1 dB from 10 MHz to 1 GHz	IFR 6960/A/B + 6912 sensor

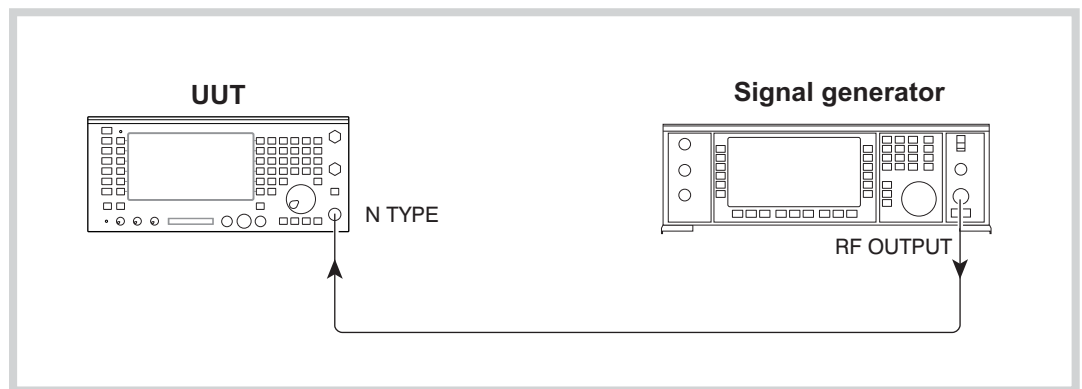

C5898

Fig. 5-16 RF spectrum analyzer checks

- (1) Refer to Results table 5-32 on page 5-41. Set the UUT to [SPEC ANA], Vid Filter ON, 10 dB/div, Res BW 300 Hz, and Peak Hold OFF, [Centre Freq] 101 MHz, [Span] 1 kHz, BNC antenna input socket, [Ref Level] -30.0 dBm.
- (2) With nothing connected to the UUT, check that the noise floor is within the bottom 10 dB graticule division of the display. (Between 70 and 80 dBm dynamic range.)
- (3) Connect the equipment as shown in Fig. 5-16, connecting the incoming signal to the N-type input socket of the UUT. Set the UUT to N-type input.
- (4) On the UUT, select [Res BW] [Manual Res BW], [30 kHz], [Ref Level] to 0 dBm.
- (5) Set the RF signal generator to provide a signal at 101 MHz at a level of 0 dBm with no modulation. Adjust the RF signal generator level until the trace sits at the top of the screen. Check that the level set on the RF signal generator is 0 dBm \pm 4 dB (Functional test only). Note this reading (reading 1).
- (6) Reduce the RF signal generator RF level until the trace sits on the graticule line 1 division down from the top line. Check that the level set on the RF signal generator is 10 dB down from reading 1 \pm 3 dB (functional test only).

ACCEPTANCE TESTING

- (7) Reduce the RF signal generator RF level until the trace sits on the graticule line 2 divisions down from the top line. Check that the level set on the RF signal generator is 20 dB down from reading 1 ± 3 dB (functional test only).
- (8) Reduce the RF signal generator RF level until the trace sits on the graticule line 3 divisions down from the top line. Check that the level set on the RF signal generator is 30 dB down from reading 1 ± 3 dB (functional test only).
- (9) Reduce the RF signal generator RF level until the trace sits on the graticule line 4 divisions down from the top line. Check that the level set on the RF signal generator is 40 dB down from reading 1 ± 3 dB (functional test only).
- (10) Reduce the RF signal generator RF level until the trace sits on the graticule line 5 divisions down from the top line. Check that the level set on the RF signal generator is 50 dB down from reading 1 ± 3 dB (functional test only).
- (11) On the UUT press *[Return]*, *[Return]*,*[Centre Freq]*, 500 MHz, *[Span]*, 999 MHz, *[Res BW]*, *[Manual Res BW]*, *[3 MHz]*, *[Vert Scale]* toggle *[10/2 dB/DIV]* until 10 dB per division is displayed.
- (12) Set the RF signal generator to 100 MHz and -6.0 dBm. Check and set this level on the power meter and then connect to the UUT.
- (13) Make a note of how many divisions down from the top of screen that the peak of the signal appears.
- (14) Repeat steps 12 and 13 for RF signal generator frequencies of 200 MHz, 400 MHz, 600 MHz and 800 MHz.
- (15) Check that the difference between the highest and the lowest point noted is 2 divisions or less.
- (16) To functionally test the look/listen facility first set the following on the UUT. Select the *[Return]* , soft key at the bottom right hand corner of the display and then *[Return]*, *[Centre Freq]*, 300 MHz, *[Return]*, *[Vert Scale]*, toggle *[10/2 DB /DIV]* until 10 dB per division is displayed, *[Span]*, 100 kHz, *[Res BW]*, *[Auto Res BW]*.
- (17) Set the RF signal generator to provide a signal of 300 MHz at a level of -10 dBm. A signal should now appear at the centre of the UUT display and be on or close to 1 division down from the top of the display.
- (18) On the UUT select look and listen mode by pressing the *[Return]* soft key at the bottom left hand corner of the display and then the *[Look n Listen]* soft key.
- (19) Check that the signal is still at the centre of the display and on or close to 1 division down from the top of the display.
- (20) Set the RF signal generator to provide 10 kHz deviation at 1 kHz modulation rate on the 300 MHz signal.
- (21) Check that the UUT display now shows an FM modulated signal. Turn the front panel volume control up and check that a 1 kHz tone can be heard. This verifies the operation of the look/listen mode of the Spectrum analyzer. The tracking generator is in reality the instrument signal generator and is therefore tested when the signal generator is checked.

RF broadband power meter

Specification

Frequency range:	200 kHz to 1.05 GHz
Accuracy:	$\pm 10\% \pm$ resolution (N-type)
Resolution:	0.1 dB

Test equipment

Description	Minimum specification	Example
Calibrated RF power source consisting of:-	Accuracy better than 3.5%	See below
RF signal generator	11 MHz to 1 GHz frequency range, RF level 13 dBm	IFR 2041
Power splitter	6 dB 50 Ω 11 MHz to 1 GHz	Weinschel 1870A
RF Amplifier	3W 40 dB gain 11 MHz to 1000 MHz	IFR 2177 or AR5W1000 MHz
Attenuator pads	Values dependent upon amplifier used	
RF power meter	± 0.1 dB from 11 MHz to 1 GHz	IFR 6960/A/B + 6912 sensor

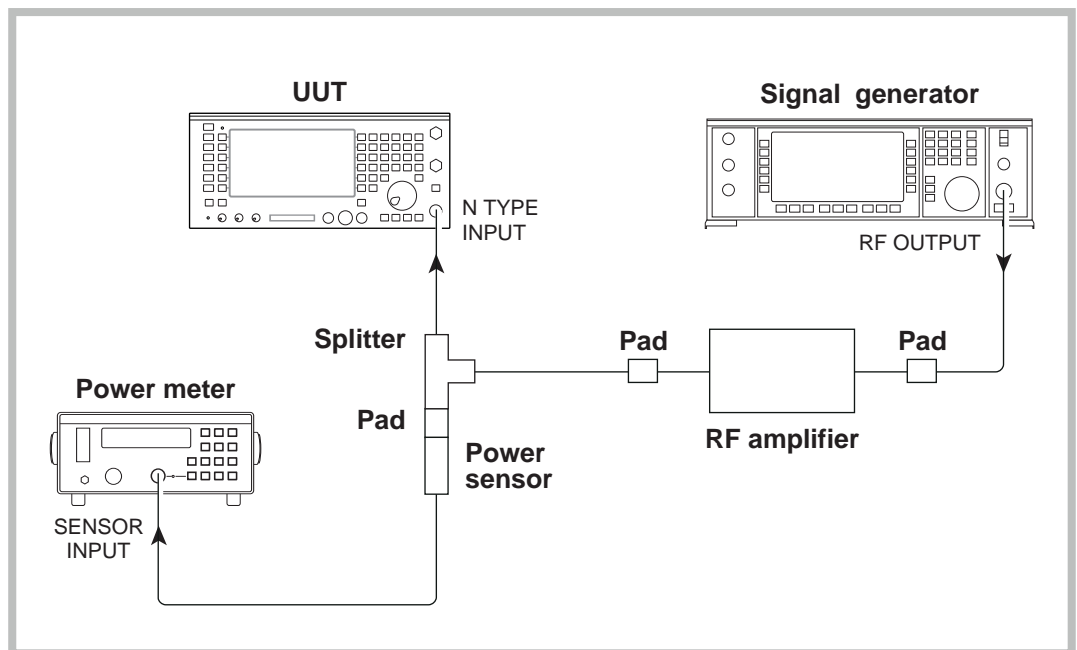

C2595

Fig. 5-17 RF broadband power meter checks

- (1) Refer to Results table 5-33 on page 5-42. Set the UUT to [Tx TEST], [SELECT] N-type input socket (i.e. only the \oplus LED on). From power up, the instrument should already be set to Autotune mode with wideband power meter (WB) selected.
- (2) Connect the equipment as shown in Fig. 5-17, connecting to the N-type input socket on the UUT.

- (3) Set the calibrated power source to provide a signal at 11 MHz and 100 mW(+20 dBm) to the UUT input. Note the level on the UUT broadband power meter and check that it is within the stated specification. Repeat at 100 MHz and then in 100 MHz steps up to and including 1000 MHz.
- (4) Set the calibrated power source to provide 100 MHz and 100 mW. Press [SELECT] on the UUT to select N-type input/output, i.e. both LEDs above the N-type socket on. Note the level on the UUT broadband power meter and check that it is within the stated specification.
- (5) Set the calibrated power source to provide 5 mW(+7 dBm). Note the level on the UUT broadband power meter and check that it is within the stated specification.
- (6) Press [SELECT] on the UUT to select N-type input, i.e. only the \odot LED on. Note the level on the UUT broadband power meter and check that it is within the stated specification.
- (7) Press [SELECT] on the UUT to select the antenna input socket and connect the calibrated power source to this. Note the level on the UUT broadband power meter and check that it is within 15% (functional check only).

Notes:

- (1) The power meter/sensor, splitter and two pads associated with these items form the calibrated part of the source.
- (2) The attenuator pad values are dependent upon the gain of the amplifier used. They should be chosen so that when the signal generator is set to its maximum output level the power arriving at the sensor is below +25 dBm i.e. not enough to damage the sensor.
- (3) If a calibrated power source is not available, the UUT power measurement can be functionally checked using an RF signal generator and power meter by checking the signal generator level before applying it to the UUT. It should be noted that no guarantees can be given of the mismatch uncertainties that may be introduced if this method is used.

Signalling systems

The Analog System test facility make use of the circuitry already tested under the standard instrument tests but also has an additional circuit board. This board contains digital circuitry to cater for data generation, data decoding and test programme execution. It uses digital signal processing to implement the special filtering required. The most effective way of testing the operation of the facility is to ensure that it is possible to call up each system and then carry out a functional test with a mobile for that system.

For details on connection of mobiles to the UUT, refer to the relevant Operating Manual Supplement for the option fitted.

Acceptance Test Results Tables

For 2948B [], serial number _____ / _____

Results table 5-1 Carrier frequency accuracy

Frequency	Lower limit	Upper limit	Result
400.000 kHz	399.999	400.001	_____
1050.00000 MHz	1049.999999	1050.000001	_____
500.00000 MHz	499.999999	500.000001	_____
188.88888 MHz	188.888879	188.888881	_____
177.77777 MHz	177.777769	177.777771	_____
166.66666 MHz	166.666659	166.666661	_____
155.55555 MHz	155.555549	155.555551	_____
144.44444 MHz	144.444439	144.444441	_____
133.33333 MHz	133.333329	133.333331	_____
122.22222 MHz	122.222219	122.222221	_____
111.11111 MHz	111.111109	111.111111	_____

Results table 5-2 Signal generator level (-21 dBm) versus frequency (MHz)

Frequency	Lower limit (dBm)	Upper limit (dBm)	Result N-type out/ Antenna in	Result N-type out/ N-type in
10 MHz	-23	-19	_____	_____
100 MHz	-23	-19	_____	_____
200 MHz	-23	-19	_____	_____
300 MHz	-23	-19	_____	_____
400 MHz	-23	-19	_____	_____
500 MHz	-23	-19	_____	_____
600 MHz	-23	-19	_____	_____
700 MHz	-23	-19	_____	_____
800 MHz	-23	-19	_____	_____
900 MHz	-23	-19	_____	_____
1000 MHz	-23	-19	_____	_____

ACCEPTANCE TESTING

Results table 5-3 ALC linearity at 10 MHz

Level (dBm)	Lower limit	Upper limit	Result
-21	-23.0	-19.0	_____
-22	-24.0	-20.0	_____
-23	-25.0	-21.0	_____
-24	-26.0	-22.0	_____
-25	-27.0	-23.0	_____
-26	-28.0	-24.0	_____
-27	-29.0	-25.0	_____
-28	-30.0	-26.0	_____
-29	-31.0	-27.0	_____
-30	-32.0	-28.0	_____
-31	-33.0	-29.0	_____
-32	-34.0	-30.0	_____
-33	-35.0	-31.0	_____
-34	-36.0	-32.0	_____
-35	-37.0	-33.0	_____
-36	-38.0	-34.0	_____
-37	-39.0	-35.0	_____
-38	-40.0	-36.0	_____

Results table 5-4 ALC linearity at 500 MHz

Level (dBm)	Lower limit	Upper limit	Result
-21	-23.0	-19.0	_____
-22	-24.0	-20.0	_____
-23	-25.0	-21.0	_____
-24	-26.0	-22.0	_____
-25	-27.0	-23.0	_____
-26	-28.0	-24.0	_____
-27	-29.0	-25.0	_____
-28	-30.0	-26.0	_____
-29	-31.0	-27.0	_____
-30	-32.0	-28.0	_____
-31	-33.0	-29.0	_____
-32	-34.0	-30.0	_____
-33	-35.0	-31.0	_____
-34	-36.0	-32.0	_____
-35	-37.0	-33.0	_____
-36	-38.0	-34.0	_____
-37	-39.0	-35.0	_____
-38	-40.0	-36.0	_____

ACCEPTANCE TESTING

Results table 5-5 ALC linearity at 1000 MHz

Level (dBm)	Lower limit	Upper limit	Result
-21	-23.0	-19.0	_____
-22	-24.0	-20.0	_____
-23	-25.0	-21.0	_____
-24	-26.0	-22.0	_____
-25	-27.0	-23.0	_____
-26	-28.0	-24.0	_____
-27	-29.0	-25.0	_____
-28	-30.0	-26.0	_____
-29	-31.0	-27.0	_____
-30	-32.0	-28.0	_____
-31	-33.0	-29.0	_____
-32	-34.0	-30.0	_____
-33	-35.0	-31.0	_____
-34	-36.0	-32.0	_____
-35	-37.0	-33.0	_____
-36	-38.0	-34.0	_____
-37	-39.0	-35.0	_____
-38	-40.0	-36.0	_____

Results table 5-6 Carrier harmonic test points at 0 dBm

Frequency (MHz)	Second harmonic (MHz)	Result	Third harmonic (MHz)	Result	Upper limit (dBc)
0.4	0.8	_____	1.2	_____	-25
100.0	200.0	_____	300.0	_____	-25
300.0	600.0	_____	900.0	_____	-25
500.0	1000.0	_____	1500.0	_____	-25
700.0	1400.0	_____	2100.0	_____	-25
900.0	1800.0	_____	2700.0	_____	-25
1000.0	2000.0	_____	3000.0	_____	-25

Results table 5-7 Spurious signals (carrier at 0 dBm)

Carrier frequency (MHz)	Spurious measured	Upper limit (dBc)
0.4	_____	-50
500	_____	-50
1000	_____	-50
650	_____	-50

ACCEPTANCE TESTING

Results table 5-8 Residual FM test points

UUT RF generator frequency (MHz)	Local oscillator frequency (MHz)	Limits (Hz)	Result
1000	55.63889	12	_____
925	54.50000	12	_____
730	52.25000	12	_____
502	55.94444	12	_____
240	48.30000	12	_____
20		12	_____

Results table 5-9 AM versus carrier frequency (50% depth at 1 kHz rate)

Carrier frequency (MHz)	Lower limit (%)	Upper limit (%)	Result (%)
1.5	46.5	53.5	_____
50	46.5	53.5	_____
100	46.5	53.5	_____
150	46.5	53.5	_____
200	46.5	53.5	_____
250	46.5	53.5	_____
300	46.5	53.5	_____
350	46.5	53.5	_____
400	46.5	53.5	_____

Results table 5-10 FM versus carrier frequency (at 10 kHz deviation 1 kHz rate)

Carrier frequency (MHz)	Lower limit (kHz)	Upper limit (kHz)	Result
0.5	9.290	10.710	_____
10	9.290	10.710	_____
100	9.290	10.710	_____
200	9.290	10.710	_____
300	9.290	10.710	_____
400	9.290	10.710	_____
500	9.290	10.710	_____
600	9.290	10.710	_____
700	9.290	10.710	_____
800	9.290	10.710	_____
900	9.290	10.710	_____
925	9.290	10.710	_____
975	9.290	10.710	_____
1050	9.290	10.710	_____

ACCEPTANCE TESTING

Results table 5-11 FM linearity checks (at 600 MHz carrier frequency 1 kHz rate)

Deviation frequency (kHz)	Lower limit (kHz)	Upper limit (kHz)	Result
75	69.74	80.26	_____
50	46.49	53.51	_____
25	23.24	26.76	_____
5	4.64	5.36	_____

Results table 5-12 Audio generator 1 output level

AF generator 1 frequency (Hz)	Level (mV)	Lower limit (mV)	Upper limit (mV)	Result
1000	4000	3799	4201	_____
50	4000	3799	4201	_____
150	4000	3799	4201	_____
500	4000	3799	4201	_____
2000	4000	3799	4201	_____
5000	4000	3799	4201	_____
10000	4000	3799	4201	_____
15000	4000	3799	4201	_____
1000	20.0	18.9	21.1	_____
1000	400.0	379.9	420.1	_____
1000	1000	949	1051	_____
1000	2000	1899	2101	_____
1000	3000	2849	3151	_____

Results table 5-13 Audio generator 2 output level

AF generator 2 frequency (Hz)	Level (mV)	Lower limit (mV)	Upper limit (mV)	Result
1000	4000	3799	4201	_____
50	4000	3799	4201	_____
150	4000	3799	4201	_____
500	4000	3799	4201	_____
2000	4000	3799	4201	_____
5000	4000	3799	4201	_____
10000	4000	3799	4201	_____
15000	4000	3799	4201	_____
1000	20.0	18.9	21.1	_____
1000	400.0	379.9	420.1	_____
1000	1000	949	1051	_____
1000	2000	1899	2101	_____
1000	3000	2849	3151	_____

ACCEPTANCE TESTING

Results table 5-14 Audio generator 1 distortion

AF generator 1 frequency (Hz)	Level (mV)	Distortion upper limit (%)	Result
1000	4000	0.5	_____
1000	100.0	0.5	_____
2000	4000	1.0	_____
5000	4000	1.0	_____
15000	4000	1.0	_____

Results table 5-15 Audio generator 2 distortion

AF generator 2 frequency (Hz)	Level (mV)	Distortion upper limit (%)	Result
1000	4000	0.5	_____
1000	100.0	0.5	_____
2000	4000	1.0	_____
5000	4000	1.0	_____
15000	4000	1.0	_____

Results table 5-16 Audio generator 1 frequency (functional)

AF generator 1 setting	Lower limit	Upper limit	Result
10 Hz	9.9 Hz	10.1 Hz	_____
500 Hz	499.9 Hz	500.1 Hz	_____
1.0000 kHz	999.9 Hz	1000.1 Hz	_____
1.1111 kHz	1.1110 kHz	1.1112 kHz	_____
2.2222 kHz	2.2221 kHz	2.2223 kHz	_____
3.333 kHz	3.3328 kHz	3.3332 kHz	_____
4.444 kHz	4.4438 kHz	4.4442 kHz	_____
5.555 kHz	5.5548 kHz	5.5552 kHz	_____
6.666 kHz	6.6658 kHz	6.6662 kHz	_____
7.777 kHz	7.7768 kHz	7.7772 kHz	_____
8.888 kHz	8.8878 kHz	8.8882 kHz	_____
9.999 kHz	9.9988 kHz	10.0010 kHz	_____
15.000 kHz	14.999 kHz	15.0010 kHz	_____
20.000 kHz	19.9989 kHz	20.0011 kHz	_____

ACCEPTANCE TESTING

Results table 5-17 Audio generator 2 frequency (functional)

AF generator 2 setting	Lower limit	Upper limit	Result
10 Hz	9.9 Hz	10.1 Hz	_____
500 Hz	499.9 Hz	500.1 Hz	_____
1.0000 kHz	999.9 Hz	1000.1 Hz	_____
1.1111 kHz	1.1110 kHz	1.1112 kHz	_____
2.2222 kHz	2.2221 kHz	2.2223 kHz	_____
3.333 kHz	3.3328 kHz	3.3332 kHz	_____
4.444 kHz	4.4438 kHz	4.4442 kHz	_____
5.555 kHz	5.5548 kHz	5.5552 kHz	_____
6.666 kHz	6.6658 kHz	6.6662 kHz	_____
7.777 kHz	7.7768 kHz	7.7772 kHz	_____
8.888 kHz	8.8878 kHz	8.8882 kHz	_____
9.999 kHz	9.9988 kHz	10.0010 kHz	_____
15.000 kHz	14.999 kHz	15.0010 kHz	_____
20.000 kHz	19.9989 kHz	20.0011 kHz	_____

Results table 5-18 Audio frequency meter

LF generator frequency	Level (mV)	Lower limit	Upper limit	Result
20 Hz	50	19.8 Hz	20.2 Hz	_____
1 kHz	50	999.8 Hz	1000.2 Hz	_____
20 kHz	50	19.9989 kHz	20.0011 kHz	_____

ACCEPTANCE TESTING

Results table 5-19 Audio voltmeter accuracy

Frequency	DVM reading (mV)	UUT coupling	UUT lower limit* (mV) ‡	UUT upper limit* (mV) †	Result
1 kHz	30	AC	25.1	34.9	_____
1 kHz	200	AC	189	211	_____
1 kHz	400	AC	381	419	_____
1 kHz	800	AC	765	835	_____
1 kHz	2000	AC	1917	2083	_____
1 kHz	4500	AC	3317	4683	_____
50 Hz	1000	AC	957	1043	_____
100 Hz	1000	AC	957	1043	_____
500 Hz	1000	AC	957	1043	_____
10 kHz	1000	AC	957	1043	_____
30 kHz	1000	AC	957	1043	_____
50 kHz	1000	AC	957	1043	_____
DC	25000	DC	23997	26003	_____
DC	50000	DC	47997	52003	_____

† The upper and lower limits in the above table are calculated on the assumption that it was possible to set the exact level. If it is not possible to achieve this, the limits will need to be calculated for the DVM reading obtained.

Results table 5-20 Distortion & SINAD meter

Distortion/SINAD set	Lower limit	Upper limit	Result
2%	1.4%	2.6 %	_____
25%	23.2%	26.8 %	_____
12 dB	11.0 dB	13 0 dB	_____

Results table 5-21 FM measurement versus carrier frequency (1 kHz rate)

Carrier frequency (MHz)	Deviation (kHz)	IF filter (kHz)	AF filter	Lower limit (kHz) †	Upper limit (kHz) †	Result
5.5	20	30	0.3 to 3.4	18.8	21.2	_____
500	20	30	0.3 to 3.4	18.8	21.2	_____
1000	20	30	0.3 to 3.4	18.8	21.2	_____

ACCEPTANCE TESTING

Results table 5-22 FM measurement versus deviation level (1 kHz rate)

Deviation level	IF bandwidth	Lower limit (kHz) †	Upper limit (kHz) †	Result
250 Hz ‡	3 kHz	0.2275	0.2725	_____
10 kHz	30 kHz	9.4	10.6	_____
50 kHz	300 kHz	47	53	_____
75 kHz	300 kHz	70.5	79.5	_____

† The upper and lower limits in Results table 5-21, and Results table 5-22 are calculated on the assumption that it was possible to set the exact level on the external Modulation meter. If it is not possible to achieve this, the limits will need to be calculated for the readings obtained.

‡ For the lower deviation in Results table 5-22, subtract the residual FM reading from the measured result.

Results table 5-23 FM demodulation oscilloscope

Carrier frequency (MHz)	Deviation (kHz)	Lower limit (kHz)	Upper limit (kHz)	Result
300	75	67.5	82.5	_____

Results table 5-24 FM demodulation output socket

Carrier frequency (MHz)	Deviation (kHz)	Lower limit	Upper limit	Result
300	75	4.77 V	5.83 V	_____

Results table 5-25 AM measurement versus carrier frequency (1 kHz rate)

Carrier frequency (MHz)	Depth (%)	Lower limit (%) †	Upper limit (%) †	Result
0.5	70	66	74	_____
500	70	66	74	_____
1050	70	66	74	_____

Results table 5-26 AM measurement versus modulation rate

Modulation rate	Depth (%)	Lower limit (%) †	Upper limit (%) †	Result
50 Hz	70	64	76	_____
10 kHz	70	64	76	_____

ACCEPTANCE TESTING

Results table 5-27 AM measurement versus AM depth (1 kHz rate)

Depth (%)	Lower limit (%) †	Upper limit (%) †	Result
5	3.75	6.25	_____
20	18	22	_____
50	46.5	53.5	_____
80	75	85	_____
95	89	100	_____

Results table 5-28 AM demodulation oscilloscope

Carrier frequency (MHz)	Depth (%)	Lower limit (%) †	Upper limit (%) †	Result
100	60	54	66	_____

† The upper and lower limits in Results table 5-25, Results table 5-26, Results table 5-27, and Results table 5-28 are calculated on the assumption that it was possible to set the exact level on the external Modulation meter. If it is not possible to achieve this, the limits will need to be calculated for the DVM readings obtained.

ACCEPTANCE TESTING

Results table 5-29 RF frequency meter (at -60 dBm antenna input, manual tuned)

Carrier frequency (MHz)	Offset lower limit (Hz)	Offset upper limit (Hz)	Result
10	-1	1	_____
500	-1	1	_____
1050	-1	1	_____

Results table 5-30 RF frequency meter (at -13 dBm (0.05mw) antenna input autotuned)

Carrier frequency (MHz)	Lower limit (MHz)	Upper limit (MHz)	Result
1000	999.999999	1000.000001	_____
500	499.999999	500.000001	_____
10	9.999999	10.000001	_____

Results table 5-31 Internal frequency standard

Carrier frequency (MHz)	Lower limit (MHz)	Upper limit (MHz)	Result
1000	999.999750	1000.000250	_____

Results table 5-32 Spectrum analyzer

Parameter	Limits	Result
Dynamic range	>70 dB	_____
Level flatness	<2 dB	_____

ACCEPTANCE TESTING

Results table 5-33 RF broadband power meter (N-type input)

Frequency (MHz)	Input level (dBm)	Lower limit (dBm)	Upper limit (dBm)	Result
N-input				
11	20	19.4	20.5	_____
100	20	19.4	20.5	_____
200	20	19.4	20.5	_____
300	20	19.4	20.5	_____
400	20	19.4	20.5	_____
500	20	19.4	20.5	_____
600	20	19.4	20.5	_____
700	20	19.4	20.5	_____
800	20	19.4	20.5	_____
900	20	19.4	20.5	_____
1000	20	19.4	20.5	_____
N in / N out				
100	20	19.4	20.5	_____
100	7	6.4	7.5	_____
N input				
100	7	6.4	7.5	_____

The upper and lower limits in the table above are calculated on the assumption that it was possible to set the exact input level required. If it is not possible to achieve this, the limits will need to be calculated in proportion to the power applied.

Appendix A

DIRECTIONAL POWER HEADS

Contents

Features	A-7
Performance data - power head only.....	A-8
Performance data - in conjunction with 2948B	A-10
Additional parts associated with directional power head.....	A-13
Supplied	A-13
Optional	A-13
Using the directional power head accessory	A-14
General.....	A-14
Power supply	A-14
Procedure	A-14
Technical description	A-16
Directional coupler assembly.....	A-16
Channel circuit.....	A-16
Control circuit.....	A-16
Power supply and oscillator.....	A-16

List of tables

Table A-1 Conversion of VSWR to return loss	A-13
---	------

List of figures

Fig. A-1 Power range of HF directional power head.....	A-11
Fig. A-2 Power range of UHF directional power head	A-11
Fig. A-3 VSWR range for HF and UHF directional power heads.....	A-12
Fig. A-4 Percentage to dB error conversion	A-12
Fig. A-5 Directional power head screen	A-14
Fig. A-6 Simplified block diagram of HF or UHF power head	A-17

Precautions

WARNING

CAUTION

Note

These terms have specific meanings in this manual:

WARNING

information to prevent personal injury.

CAUTION

information to prevent damage to the equipment.

Note

important general information.

Hazard symbols

The meaning of hazard symbols appearing on the equipment is as follows:

Symbol **Nature of hazard**



RF Hazard



Toxic hazards

Safety

This product has been designed and tested in accordance with BS4743 'Specification for safety requirements for electronic measuring apparatus' and IEC Publication 348 'Safety requirements for electronic measuring apparatus'.

WARNING



RF hazard

When measuring high VSWR ratios, hazardous voltages may be present on the line due to standing waves. Under these conditions, it is dangerous to operate the equipment with the covers removed.

WARNING



Toxic hazards

Some of the components used in this equipment may include resins and other materials which give off toxic fumes if incinerated. Take appropriate precautions, therefore, in the disposal of these items.

Précautions

WARNING

CAUTION

Note

Les termes suivants ont, dans ce manuel, des significations particulières:

WARNING

contient des informations pour éviter toute blessure au personnel.

CAUTION

contient des informations pour éviter les dommages aux équipements.

Note

contient d'importantes informations d'ordre général.

Symboles Signalant Un Risque

Symbole

Nature du risque



Danger RF



Danger produits toxiques

Securite

Cet appareil a été conçu et testé conformément aux normes BS4743 "Spécifications des conditions de sécurité pour instruments de mesure électronique" et CEI Publication 348 "Conditions de sécurité pour instruments de mesure électronique".

WARNING



Danger RF

Lors de la mesure de T.O.S. de valeur importante, des tensions dangereuses dues aux ondes stationnaires peuvent apparaître sur l'alimentation. Dans ces conditions il est dangereux de faire fonctionner l'appareil sans ses capots de protection.

WARNING



Danger produits toxiques

Certains composants utilisés dans cet appareil peuvent contenir des résines et d'autres matières qui dégagent des fumées toxiques lors de leur incinération. Les précautions d'usages doivent donc être prises lorsqu'on se débarrasse de ce type de composant.

Vorsichtsmaßnahmen

WARNING

CAUTION

Note

Diese Hinweise haben eine bestimmte Bedeutung in diesem Handbuch:

WARNING

dienen zur Vermeidung von Verletzungsrisiken.

CAUTION

dienen dem Schutz der Geräte.

Note

enthalten wichtige Informationen.

Gefahrensymbole

Die Gefahrensymbole auf den Geräten sind wie folgt:

Symbol

Gefahrenart



Hochfrequenz



Warnung vor giftigen Substanzen

Sicherheit

Dieses Gerät wurde in Übereinstimmung mit BS4743 und IEC 348 entwickelt und geprüft.

WARNING



Hochfrequenz

Bei Messung von hohen Stehwellenverhältnissen können sich auf der Leitung gefährliche Spannungen aufbauen. In solchen Fällen darf das Gerät nicht bei geöffnetem Gehäuse betrieben werden.

WARNING



Warnung vor giftigen Substanzen

In einigen Bauelementen dieses Geräts können Epoxyharze oder andere Materialien enthalten sein, die im Brandfall giftige Gase erzeugen. Bei der Entsorgung müssen deshalb entsprechende Vorsichtsmaßnahmen getroffen werden.

Precauzioni

WARNING

CAUTION

Note

Questi termini vengono utilizzati in questo manuale con significati specifici:

WARNING

riportano informazioni atte ad evitare possibili pericoli alla persona.

CAUTION

riportano informazioni per evitare possibili pericoli all'apparecchiatura.

Note

riportano importanti informazioni di carattere generale.

Simboli di pericolo

Significato dei simboli di pericolo utilizzati nell'apparato:

Simbolo

Tipo di pericolo



Rischio a RF



Pericolo sostanze tossiche

Sicurezza

Questo prodotto è stato progettato e provato secondo le norme BS4743 "Specification for safety requirements for electronic measuring apparatus" e la pubblicazione IEC 348 "Safety requirements for electronic measuring apparatus".

WARNING



Rischio a RF

Durante la misura di ROS di valori elevati, la presenza di onde stazionarie può causare tensioni pericolose. In queste condizioni è quindi rischioso usare lo strumento coi coperchi rimossi.

WARNING



Pericolo sostanze tossiche

Alcuni dei componenti usati in questo strumento possono contenere resine o altri materiali che, se bruciati, possono emettere fumi tossici. Prendere quindi le opportune precauzioni nell'uso di tali parti.

Precauciones

WARNING

CAUTION

Note

Estos términos tienen significados específicos en este manual:

WARNING

contienen información referente a prevención de daños personales.

CAUTION

contienen información referente a prevención de daños en equipos.

Note

contienen información general importante.

Símbolos de peligro

Los significados de los símbolos de peligro que aparecen en los equipos son los siguientes:

Símbolo **Naturaleza del peligro**



Riesgo de RF



Aviso de toxicidad

Seguridad

Este producto ha sido diseñado y probado según las normas, BS4743 'Especificaciones de los requisitos de seguridad para instrumentos electrónicos de medida' e IEC publicación 348 'Requisitos de seguridad para instrumentos electrónicos de medida'.

WARNING



Riesgo de RF

Cuando se miden valores elevados de ROE, pueden existir tensiones elevadas debido a ondas estacionarias. Bajo estas condiciones resulta peligroso operar con el equipo sin las tapas puestas.

WARNING



Aviso de toxicidad

Alguno de los componentes utilizados en este equipo pudieran incluir resinas u otro tipo de materiales que al arder produjeran sustancias tóxicas, Por tanto, tome las debidas precauciones en la manipulación de esas piezas.

Features

This accessory is produced by IFR Ltd for use with certain of their Radio Test Sets and Communications Service Monitors. It is used to measure forward power, reverse power and VSWR in coaxial RF transmission lines and antenna systems. There are two versions as follows:-

Frequency range	Part no.
1 to 50 MHz (HF)	54421/002
25 to 1000 MHz (UHF)	54421/003

There are no controls fitted to the Directional Power Head. There are RF line input and output connectors, and a DIN socket for the lead to the Service Monitor (or test set). A 1 m lead assembly is available as an optional accessory. As the Directional Power Head is bi-directional, it can be connected either way round in the RF line.

The Directional Power Head is able to measure CW power or give an indication of peak envelope power (PEP) for AM and SSB. The *[PEP/CW]* key on the directional power meter screen is used to select the required measurement method.

A wide measurement range is available for both forward and reverse power. This can be from 10 mW to 400 W under certain some operating conditions. Range selection is automatic, controlled by the software within the Service Monitor (or test set).

A system of compensated peak responding detectors is employed to ensure fast response times and a wide dynamic range. It should be noted that the instrument is accurately calibrated for signals with low harmonic content and noise.

Performance data - power head only

	HF version	UHF version
Frequency range:	1 MHz to 50 MHz	25 MHz to 1000 MHz
Power measurement (either direction)	See Fig. A-2	See Fig. A-3
Indication range for CW:	5 mW to 400 W	5 mW to 400 W at 25 to 520 MHz, 5 mW to 200 W at 1000 MHz
Indication range for PEP:	1 to 400 W	1 to 400 W at 25 to 520 MHz, 1 to 200 W at 1000 MHz
Maximum applied PEP:	1 kW	1 kW at 25 to 100 MHz, 200 W at 1000 MHz
CW power accuracy	The quoted figures apply when the Power Head is terminated by a load which has a VSWR of 1.1:1 or better and within the temperature range 18 to 26°C	
Calibration at 1 W (with harmonics <-50 dBc):	±4.7% (±0.2 dB) at 30 MHz	±4.7% (±0.2 dB) at 100 MHz
Flatness:	±3.6% (±0.155 dB) at 1 to 50 MHz	±5.9% (±0.25 dB) at below 520 MHz, ±9.6% (±0.4 dB) at 520 to 1000 MHz
Linearity, relative to 1 W:	±3.5% (±0.15 dB) ±0.003% of maximum power of Head, at 10 mW to 400 W	3.5% (±0.15 dB) ±0.01% of maximum power of Head
Calibration, flatness and linearity combined (root of sum of squares):	±7% (±0.29 dB) ±0.003% of maximum power of Head	±8% (±0.35 dB) ±0.01% of maximum power of Head, at 25 to 520 MHz, ±11% (±0.5 dB) ±0.01% of maximum power of Head, at 520 to 1000 MHz
Effect of temperature outside 18 to 26°C on calibration, flatness and linearity:	<±0.2%/°C (±0.008 dB/°C)	<±0.3%/°C (±0.015 dB/°C) at below 520 MHz, <±0.5%/°C (±0.02 dB/°C) at 520 to 1000 MHz
VSWR measurement	See Fig. A-3	See Fig. A-3
VSWR indication:	1.0 to 99.9	1.0 to 99.9
VSWR accuracy at 18 to 26°C:	±12.5% for 1.1:1 to 2:1 (typically 3%), ±15% for 2:1 to 3:1 (typically 4%)	±16% for 1.1:1 to 2:1 (typically 5%), ±20% for 2:1 to 3:1 (typically 6%)

DIRECTIONAL POWER HEADS

RF connectors

Type:	N sockets	N sockets
Characteristic impedance:	50 Ω nominal	50 Ω nominal
Insertion SWR:	<1.1:1 (return loss >26.4 dB) at 1 to 50 MHz	<1.1:1 (return loss >26.4 dB) at 25 to 1000 MHz
Insertion loss:	<0.05 dB	<0.35 dB at up to 520 MHz, <0.65 dB at 520 to 1000 MHz

Output connector

Type:	DIN 7-pin socket, standard Lead Assembly (3 m) to ACCESSORY socket on Service Monitor
-------	--

Dimensions and weight

Height:	52 mm	52 mm
Width:	108 mm	108 mm
Depth:	114 mm	114 mm
Weight:	645 g	850 g

Radio frequency interference:

Electro-Magnetic Compatibility	Conforms with the protection requirements of the EEC Council Directive 89/336/EEC Complies with the limits specified in the following standards: EN 55011 Class B CISPR 11 EN50082-1 IEC 801-2,3,4
--------------------------------	--

Safety:

Complies with IEC 348

Environmental

Rated range of use:	0 to 50°C
Limit range of operation:	0 to 55°C

Conditions of storage and transport

Temperature:	-40 to +70°C
Humidity:	Up to 90% RH
Altitude:	Up to 2500 m (pressurised freight at 27 kPa differential (i.e. 3.9 lbf/in ²))

Performance data - in conjunction with 2948B

When the Power Head is used in conjunction with the Communications Service Monitor 2948, the performance is identical to that of the Power Head alone with the exceptions and additions given below.

	HF version	UHF version
Power measurement		
Resolution:	1 mW or 0.1 dB	
Indication:	3 digits	
Setting:	Automatic ranging using 0 to 1, 0 to 3 and 0 to 10 scales	
Accuracy (including errors due to frequency response, linearity and calibration uncertainties combined (root of sum of squares)):	$\pm 8\%$ ($\pm 0.003\%$ of maximum power of Head)	$\pm 9\%$ ($\pm 0.01\%$ of maximum power of Head) at 25 to 520 MHz, $\pm 12\%$ ($\pm 0.01\%$ of maximum power of Head) at 520 to 1000 MHz
VSWR measurements		
Resolution:	0.01	
Indication:	3 digits and analogue display	
Setting:	Automatic ranging, analogue scales 1 to 2, 1 to 4 and 1 to 11	

DIRECTIONAL POWER HEADS

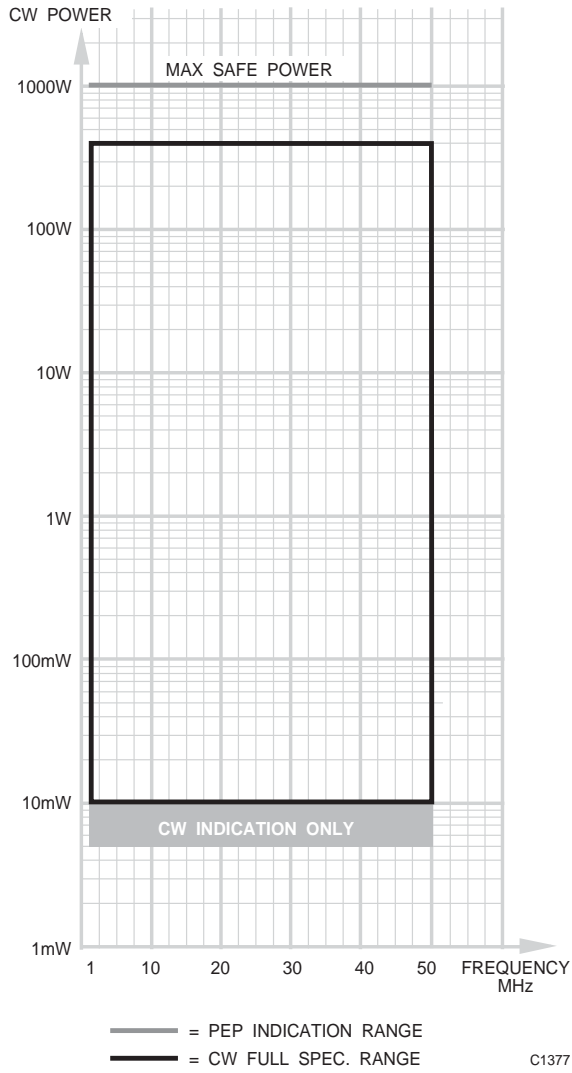

Fig. A-1 Power range of HF directional power head

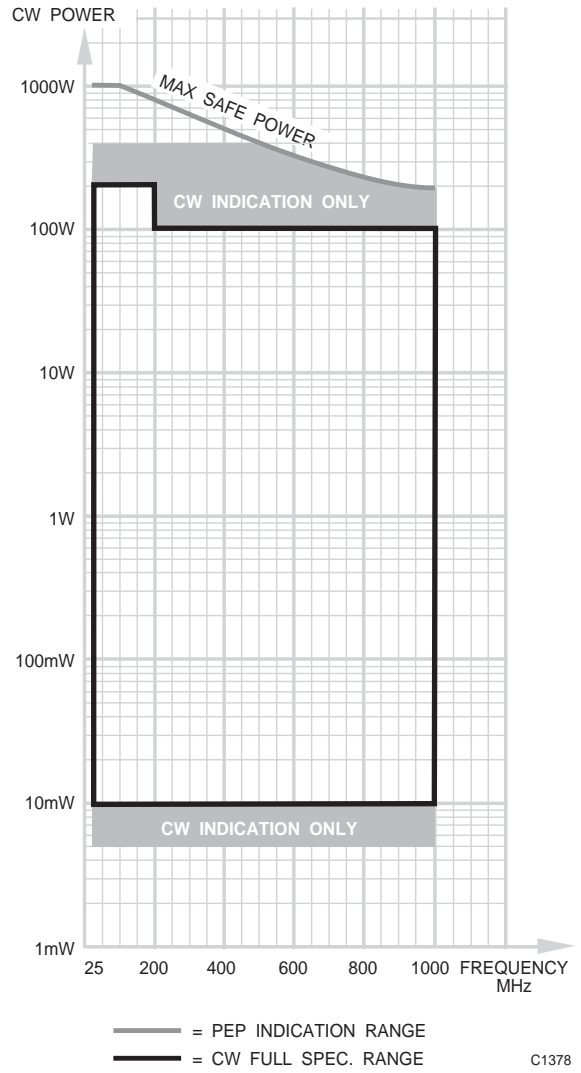
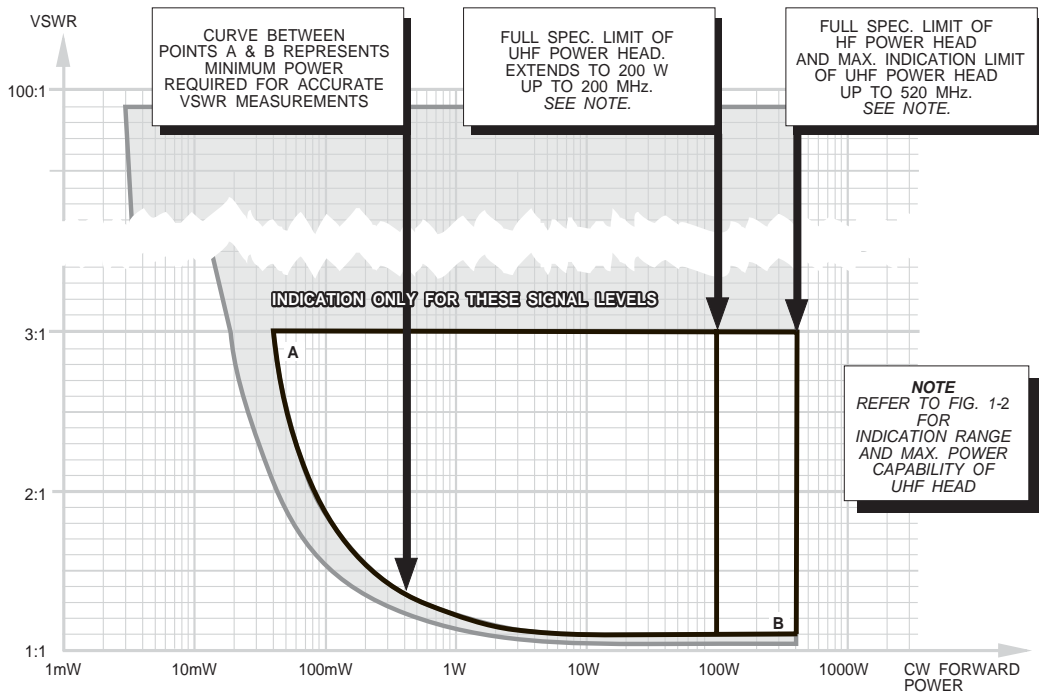

Fig. A-2 Power range of UHF directional power head

DIRECTIONAL POWER HEADS



C1379

Fig. A-3 VSWR range for HF and UHF directional power heads

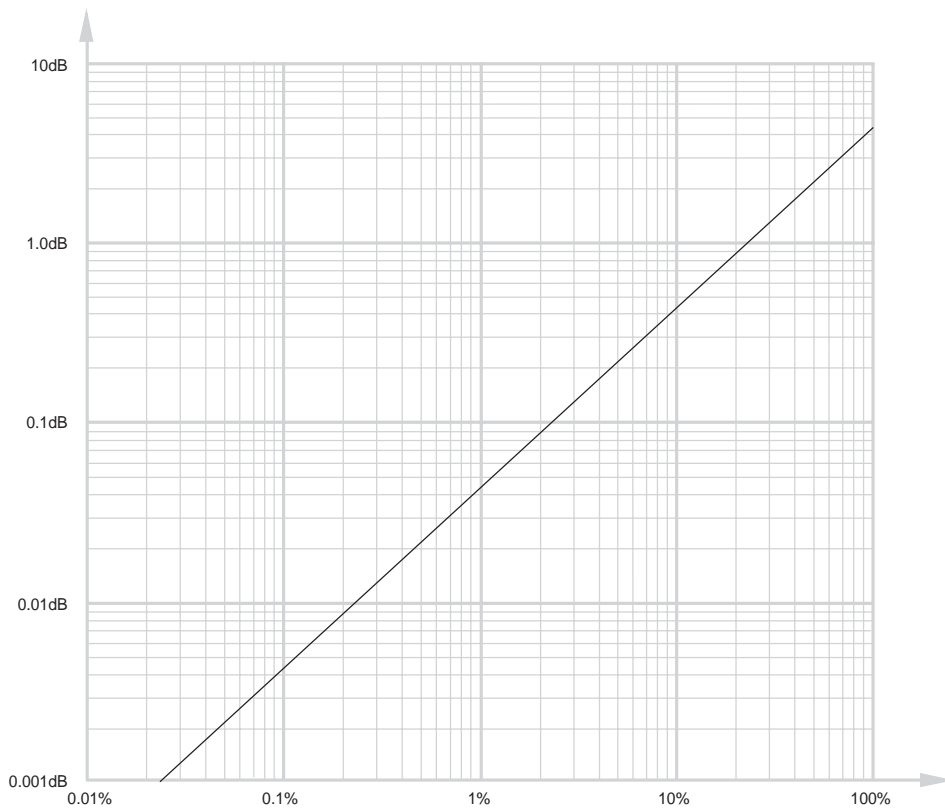

C1380

Fig. A-4 Percentage to dB error conversion

DIRECTIONAL POWER HEADS

Table A-1 Conversion of VSWR to return loss

VSWR	Return loss (dB)	VSWR	Return loss (dB)	VSWR	Return loss (dB)	VSWR	Return loss (dB)
1.00	∞	1.21	20.4	1.54	13.4	1.96	9.8
1.01	46.1	1.22	20.1	1.56	13.2	1.98	9.7
1.02	40.1	1.23	19.7	1.58	13.0	2.00	9.5
1.03	36.6	1.24	19.4	1.60	12.7	2.50	7.4
1.04	34.2	1.25	19.1	1.62	12.5	3.00	6.0
1.05	32.3	1.26	18.8	1.64	12.3	3.50	5.1
1.06	30.7	1.27	18.5	1.66	12.1	4.00	4.4
1.07	29.4	1.28	18.2	1.68	11.9	4.50	3.9
1.08	28.3	1.29	17.9	1.70	11.7	5.00	3.5
1.09	27.3	1.30	17.7	1.72	11.5	5.50	3.2
1.10	26.4	1.32	17.2	1.74	11.4	6.00	2.9
1.11	25.7	1.34	16.8	1.76	11.2	6.50	2.7
1.12	24.9	1.36	16.3	1.78	11.0	7.00	2.5
1.13	24.3	1.38	15.9	1.80	10.9	7.50	2.3
1.14	23.7	1.40	15.6	1.82	10.7	8.00	2.2
1.15	23.1	1.42	15.2	1.84	10.6	8.50	2.1
1.16	22.6	1.44	14.9	1.86	10.4	9.00	1.9
1.17	22.1	1.46	14.6	1.88	10.3	9.50	1.8
1.18	21.7	1.48	14.3	1.90	10.2	10.00	1.7
1.19	21.2	1.50	14.0	1.92	10.0	11.00	1.6
1.20	20.8	1.52	13.7	1.94	9.9		

Additional parts associated with directional power head

Supplied

	Part no.
Lead Assembly with DIN plugs, 3 m	43130/591
Carrying Case HF version	46662/190
Carrying Case UHF version	46662/189

Optional

Lead Assembly with DIN plugs, 1 m	43130/590
Dual DIN Connector Assembly	44990/814

Using the directional power head accessory

General

The supplied accessory consists of the Power Head together with the 3 metre Cable Assembly.

Power supply

No additional power supply is required. 12 V DC is supplied to the Power Head from the Service Monitor, through the cable assembly.

Procedure

WARNING

RF HAZARD. No attempt should be made to connect the Directional Power Head to an RF line until the "Operating Precautions" on page v have been noted.

Connect the accessory cable between the seven pin ACCESSORY IN/OUT socket on the Service Monitor front panel, and the seven pin DIN socket on the Power Head. These connections can be made with the Service Monitor powered up.

Select either the Tx or Dx operating mode by pressing the appropriate mode key.

Press the *[Tx Freq]* key which will display the screen shown in fold out diagram (2.1) or (4.7).

Press the *[Dir Power]* key. The screen shown in Fig. A-5 will be displayed.

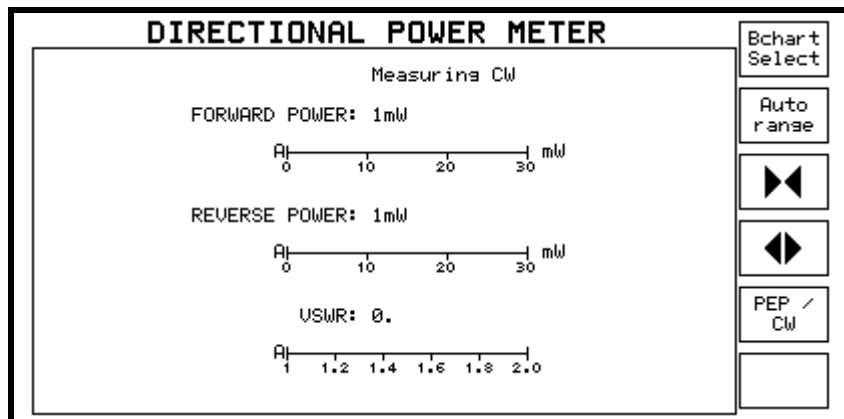

Fig. A-5 Directional power head screen

The power head is now installed and the Service Monitor ready to make directional power measurements.

Ensure that transmitter power is OFF and an antenna or load is connected to the transmitter.

Connect the Power Head in series with the transmitter output using either of the N sockets for input or output.

The Directional Power Head is able to operate in two modes, CW and PEP (when using AM or SSB). When the DIRECTIONAL POWER METER display first appears, it is in CW mode. Select CW or PEP as appropriate, using the *[CW/PEP]* key.

Switch on the transmitter under test. Readings appear for forward power, reverse power and VSWR. The values appear on three horizontal bar charts.

The forward and reverse power levels and the VSWR level, are each displayed as digital readouts with a maximum resolution of three figures. Below 10 mW the power readings are reduced to a single figure, with two digits resolution up to 99 mW.

DIRECTIONAL POWER HEADS

The bar charts can be set for auto-ranging or manual range selection. Repeated presses of the *[Bchart Select]* key selects each bar chart in turn. The selected bar chart is indicated by an **A** or **H** being shown in inverse video at the left end.

Pressing the *[Autorange]* key will switch the selected bar chart to auto-ranging, indicated by an inverse video **A**.

To change a bar chart from auto-ranging to a specific range, first select the bar chart using the *[Bchart Select]* key, then press the *[◀▶]* key or *[▶◀]* key, until the required range is selected. If the bar chart was in auto-range mode, the first press of a range change key will place the bar chart in 'Hold' mode without changing the range.

The bar chart indications of the power measurement range are covered in 10 ranges. The lowest range has a maximum indication of 30 mW, with 10 mW and 20 mW divisions. The highest range has a maximum indication of 1 kW, with 0.2, 0.4, 0.6 and 0.8 kW divisions. Between these, the ranges continue in a 1, 3, 10 sequence.

The directional power head is able to measure RF powers over a large dynamic range, from 5 mW to 400 W. The measuring circuits integrate readings over a finite period and therefore the accuracy of the readings obtained from amplitude modulated signals would depend on the content of the signal being measured.

For making measurements on CW, FM and phase modulated signals the CW measuring system is selected.

When it is required to make power measurements on amplitude modulated or single side band signals the PEP (Peak Envelope Power) system is selected. The range of measurement covered by the PEP system is from 1 W to 400 W.

The selection of CW or PEP measurements is made using the *[CW/PEP]* key. The selection is indicated by the legend *Measuring CW* or *Measuring PEP* displayed above the forward power measurement.

VSWR is shown digitally and also on a bar chart at the bottom of the display. The VSWR range is covered in two steps as shown below:-

1.0 (:1) to 2.0 (:1)..... with 1.2, 1.4, 1.6, 1.8 (:1) divisions.
1.0 (:1) to 4.0 (:1)..... with 2, 3 (:1) divisions.

Technical description

Directional coupler assembly

The directional coupler is connected in series with the RF line under test and senses forward and reverse RF power. The coupler has two outputs, one for forward power and the other for reverse power. Because the coupler can be connected in either direction on the RF line, either output could represent forward or reverse power. Each output from the coupler is routed to an RF detector.

Channel circuit

There are two channel circuits, each comprising an integrator, AGC circuit and a peak buffer. Both channel circuits are identical to each other, therefore only channel 1 is described below.

CW operation

With reference to Fig. A-6 the RF detector output is connected to one input of the integrator. The output from an LF detector is connected to the other input of the integrator. The integrator output controls the gain of the AGC circuit which controls the level of a 1 kHz signal to the LF detector.

When RF power is detected, an increased offset voltage exists at the integrator input which causes the AGC to compensate by increasing the level of LF voltage to the LF detector. The increase in LF level at the AGC circuit is routed to the Service Monitor, and is directly proportional to the increase in RF sensed by the directional coupler.

The error correcting action of the AGC/LF detector loop circuit corrects for law variations in the RF detector, thereby extending its linear output range.

The RF and LF detector diodes for each channel have matched characteristics and are mounted close together to ensure thermal equilibrium. However, DC level differences due to temperature are compensated by a unique auto-nulling scheme (patent applied for) which further extends the detector dynamic range.

PEP operation

The integrator and AGC/LF loop circuit is not suitable for AM signals, therefore for PEP operation it is switched out of circuit. The RF detector output is routed to a peak buffer which in channel 1 outputs a positive voltage and in channel 2 outputs a negative voltage proportional to the forward and reverse peak envelope voltage on the RF line under test.

Control circuit

Signal switching for CW/PEP signal paths is controlled by the Service Monitor through a control circuit hybrid in the power head. The control circuit directly controls the operation of the zero-loop circuit.

Power supply and oscillator

A power supply and oscillator circuit hybrid in the Power Head is powered by +12 V DC from the Service Monitor. It provides the nominal 1 kHz signal to each channel AGC circuit, and also ± 6.5 V DC supplies to the Power Head circuits.

DIRECTIONAL POWER HEADS

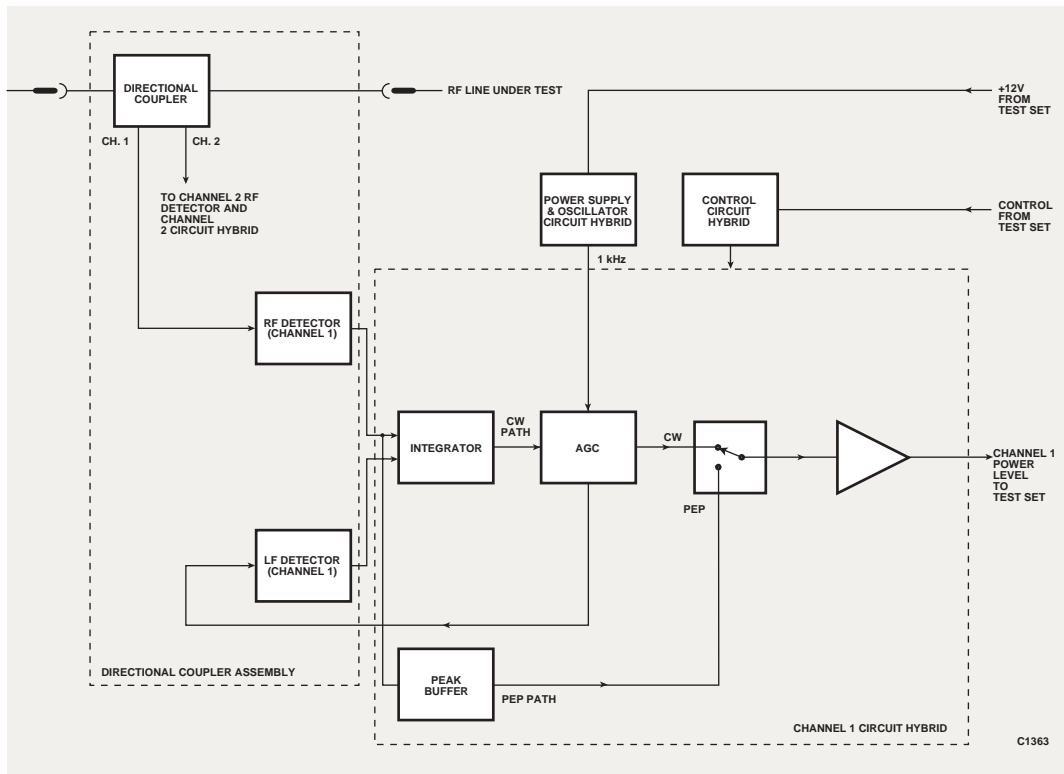

Fig. A-6 Simplified block diagram of HF or UHF power head

Appendix B AVIONICS SYSTEM

Contents

Avionics system overview	B-2
General description	B-2
ILS	B-2
Marker beacons.....	B-4
VOR.....	B-5
SELCAL	B-6
Avionics system operation	B-7
RF frequency and level	B-8
ILS	B-8
Marker beacon	B-10
VOR.....	B-11
SELCAL	B-12
ILS localiser/glideslope pairings.....	B-14

List of figures

Fig. B-1 ILS screen and menu	B-3
Fig. B-2 ILS MARKER screen and menu	B-4
Fig. B-3 VOR display screen and menu	B-5
Fig. B-4 Diagram of SELCAL tones timing	B-6
Fig. B-5 Cellular/Avionics selection menu	B-7
Fig. B-6 Avionics System top level screen and menu.....	B-7
Fig. B-7 SELCAL screen and menu	B-12

Avionics system overview

General description

The Avionics system test mode produces test signals which simulate the ground transmissions of VHF Omnidirectional Range (VOR) air navigation beacons, Instrument Landing System (ILS) aircraft blind landing equipment and Selective Calling (SELCAL) aircraft communication systems.

The presentation and control of the generated signals is tailored to the functional testing and performance evaluation of airborne radio navigation and communication equipment. The parameter values of the test signals can be varied by the user, thus allowing tests to be made to determine tolerances and 'out of specification' figures.

The portability and versatile power supply requirements of the Service Monitor allow tests to be carried out to equipment in the laboratory, the workshop or on the flightline.

The modulation applied to ILS and VOR test signals is available at the AF output connector on the front panel.

The test signals provided within the Avionics System test mode are described starting on page B-2. Instructions for using the Avionics System test mode are described starting on page B-7.

ILS

In the ILS mode the Test Set simulates the Instrument Landing System transmissions. The purpose of these signals is to indicate to the pilot/flight deck crew, the position of the aircraft relative to the landing glidepath, glideslope and runway threshold. The centerline of the runway glidepath is marked by a pair of signals known as the localizer beams. The correct angle of descent is marked by a similar pair of signals called the glideslope beams. The distance from the runway threshold is indicated by three marker beacons.

Localizer signal

The two signals used to provide the localizer beams are transmitted using aerials with sharply defined forward lobes. These are aligned to partially overlap along the glidepath center line, giving an overlap area and thus an area of equal signal strength, of approximately 5°. Both signals are derived from a common RF generator and operate within the frequency band 108 to 112 MHz. The signal transmitted to the left of the runway, as seen by an approaching aircraft, is amplitude modulated at 20% with a 90 Hz signal. The signal transmitted to the right of the runway is similarly modulated but with a 150 Hz signal. From this it will be seen that an aircraft flying along the center line will receive two signals of equal level. As the RF carriers of the two signals will be of the same frequency and phase, the receiver will interpret them as a single signal, modulated at 90 Hz and 150 Hz.

If the aircraft is flying to the left of the center line the signal with the 90 Hz modulation would predominate and give a greater depth of modulation reading. Similarly, if flying to the right of the center line the 150 Hz signal would be the stronger.

The receiver used to interrogate the signals demodulates the two tones and uses the difference in modulation depth between the two to indicate the aircraft's position relative to the glidepath center line.

The localizer beam can also be modulated with a Voice/Identity signal which will be carried with equal strength on each transmission.

The simulated localizer signal

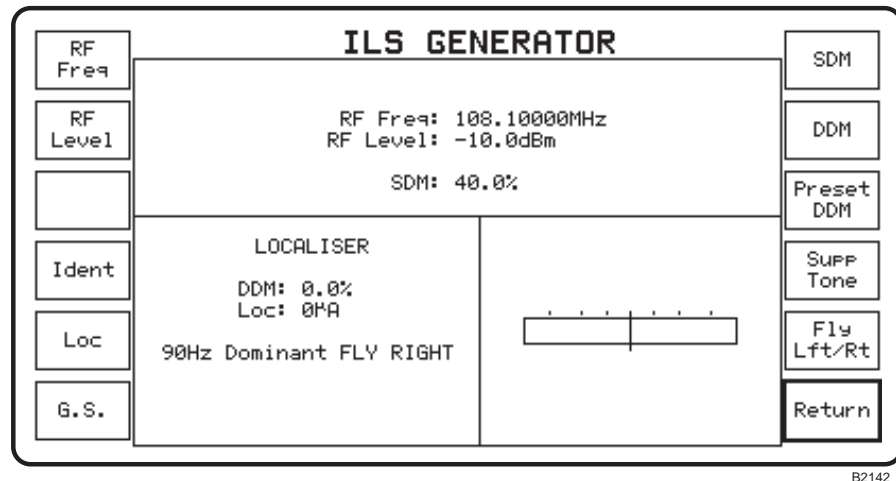

Fig. B-1 ILS screen and menu

The simulated localizer signal from the Service Monitor can be set to any of the ILS localizer carrier frequencies between 108 and 112 MHz. The carrier is amplitude modulated by signals of 90 Hz and 150 Hz. The Service Monitor ILS display screen and menu gives a graphic and digital readout of the parameters relating to the simulated signal. The soft key menu allows the parameters to be adjusted either directly or by using the data input keys or the variable control.

The localizer and glideslope carrier frequencies are inter-related. See *ILS Frequency Pairing*, below.

The depth of modulation provided by each generator is variable to simulate the position of the aircraft relative to the center line, with a horizontal bargraph giving a representative display on the screen. Each modulating signal can be disabled so as to test the operation of the 'beam lost' flag alarm.

When the [*Ident*] key is pressed the localizer carrier is amplitude modulated with a tone of approximately 1.02 kHz to simulate the voice/identity signal. The depth of modulation of this signal is adjustable.

The localizer position signals from the Service Monitor are disabled when the Ident facility is active.

Glideslope signal

The glideslope used by an aircraft approaching the runway is at a defined angle and is electronically prescribed by transmissions from a pair of antennas in a similar manner to the glidepath localizer transmissions.

The twin lobes are set to radiate at an upward angle from the runway threshold and overlap along the glideslope. The lower lobe transmits the carrier with 150 Hz amplitude modulation and the upper lobe with 90 Hz amplitude modulation. The RF frequency band allocated to glideslope transmitters is from approximately 328.5 to 336 MHz. See *ILS Frequency Pairing*, below.

The simulated glideslope signal

This signal from the Service Monitor is similar to that generated to simulate the localizer transmissions. The parameter settings can be controlled in the same way. A vertical bargraph provides the position relative to glideslope indication.

The glideslope and localizer carrier frequencies are inter-related. See *ILS frequency pairing*, below.

The ident function is not applicable to glideslope transmissions.

ILS frequency pairing

International agreements specify the carrier frequency pairings that can be used for localizer and glideslope frequencies on ILS installations. A look-up table held within the Service Monitor software contains spot frequencies from 108.10 MHz to 111.95 MHz, to provide the localizer signal. A second table, cross-referenced to the first, contains the corresponding glideslope frequencies. (See the *ILS frequency pairings* table at the end of this chapter.) A frequency setting will only be accepted as valid if it corresponds to a frequency contained in one of the look-up tables.

When a new localizer carrier frequency is set, the glideslope carrier frequency will re-set to the corresponding localizer carrier frequency.

Marker beacons

The localizer and glideslope signals do not give any information as to distance from the runway threshold. This information is provided by the ILS marker beacons.

The purpose of these markers is to inform the pilot/flight deck crew of the progress of the aircraft along the landing glidepath. Each runway approach path is equipped with three beacons, all transmitting on 75 MHz with amplitude modulation. The furthest from the touch down point, five miles from the runway threshold, transmits a tone of 400 Hz and is known as the outer marker, the next, at 3,500 ft from the threshold, transmits a 1,300 Hz tone and is known as the middle marker. The third, at the runway threshold, transmits a 3,000 Hz tone and is known as the inner marker.

The airborne receiver demodulates the tones to give an audible and visual warning as the aircraft passes each marker.

The simulated marker beacon signal

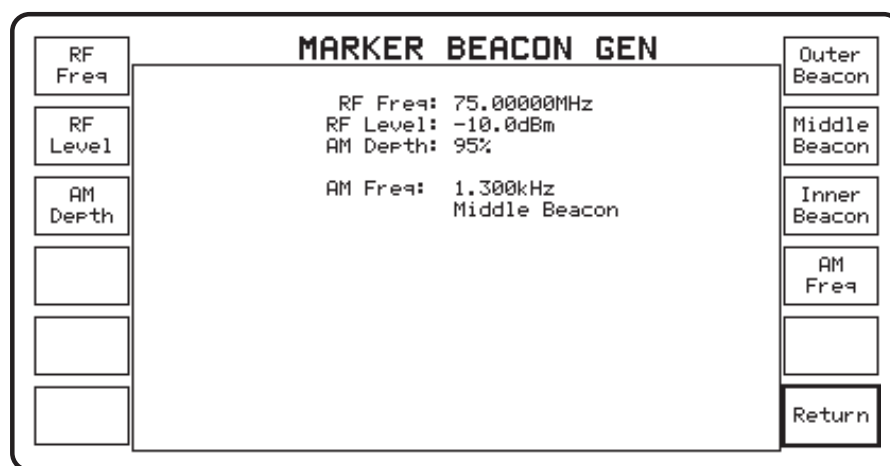

B2143

Fig. B-2 ILS MARKER screen and menu

The simulated Marker Beacon signal is a single RF carrier with accurately defined modulation frequency and level. The modulation frequency is selectable from any of the three standard marker frequencies or to any frequency within the range 20 Hz to 20.0 kHz. The parameters may be altered by the user.

The Service Monitor ILS MARKER display screen and menu gives a digital readout of the parameters relating to the simulated signal. The soft key menu allows the marker type to be selected directly or the parameters to be adjusted by using the data input keys or the variable control.

VOR

In the VOR mode the Test Set simulates the transmissions from VHF OMNIDIRECTIONAL RADIORANGE beacons.

These beacons mark the 'air corridors' used by aircraft and are situated at strategic locations throughout the world airways network.

The transmission from VOR beacons, provide information to determine the direction of the beacon from the receiver installed in the aircraft. It is a complex signal radiated partially from a horizontally polarized antenna rotating at 30 revolutions per second with a cardioid polar response pattern, and partially from a fixed omnidirectional antenna.

The rotating antenna transmits an un-modulated carrier that will appear to the receiver to be amplitude modulated at 30 Hz.

The signal from the omnidirectional antenna is at the same carrier frequency but is amplitude modulated with a 9960 Hz sub-carrier. This is frequency modulated with a 30 Hz signal synchronized with the rotating antenna, to be in phase only when received on a receiver located at a compass position due north of the beacon. At any other location the phase difference between the two 30 Hz signals is directly related to the receiver's position relative to the beacon.

The VOR signal can carry beacon identity and air traffic control information. Amplitude modulation is used to apply this directly onto the carrier.

The simulated VOR signal

The signal produced by the Service Monitor is an RF carrier within the range 108.0 MHz to 118 MHz, with a 9.960 kHz AM sub-carrier. The sub-carrier is frequency modulated with a 30 Hz reference tone. In addition to the sub-carrier, the RF signal is amplitude modulated with a 30 Hz signal which is phase variable with the 30 Hz reference tone through 360°.

The beacon identity/voice signal is simulated by applying a tone of approximately 1020 Hz to the carrier signal using amplitude modulation.

The Service Monitor VOR display screen and menu gives a graphic and digital readout of the parameters relating to the simulated signal. The soft key menu allows the parameters to be adjusted either directly or by using the data input keys or the variable control.

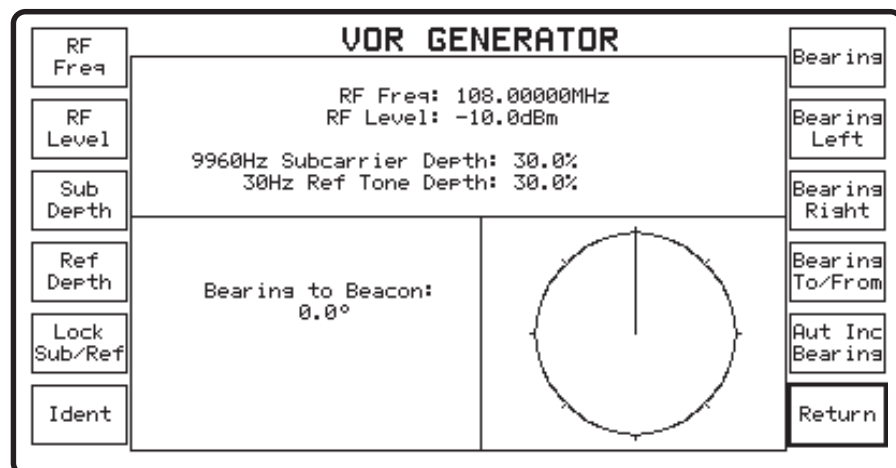

B5153

Fig. B-3 VOR display screen and menu

SELCAL

In the SELCAL mode the Test Set simulates the selective calling tones signals used on HF/VHF channels to alert a selected aircraft.

The SELCAL system is typically used by commercial aircraft operators for their company communications systems. The codes are regulated and issued by the government aviation authority. The tones are designated in two pairs of two, in the form 'BK-FB' or 'CP-AD' or 'BH-FB'. The first pair of tones from the call signal are transmitted simultaneously, i.e. BK, CP and BH in the above example, followed after a specified time by the second pair, FB, AD and FB, also sent simultaneously.

The receiver has a 'listen' condition which directs demodulated information to a tones decoder. The reception of the designated tones triggers a warning device which alerts the aircrew that they are required to communicate with the ground. Amplitude modulation is used.

The 16 available tones are designated by the letters A to S, corresponding to a table which has A being 312.6 Hz, J, 716.1 Hz and S, 1.4971 kHz. The letters I, N and O are not used.

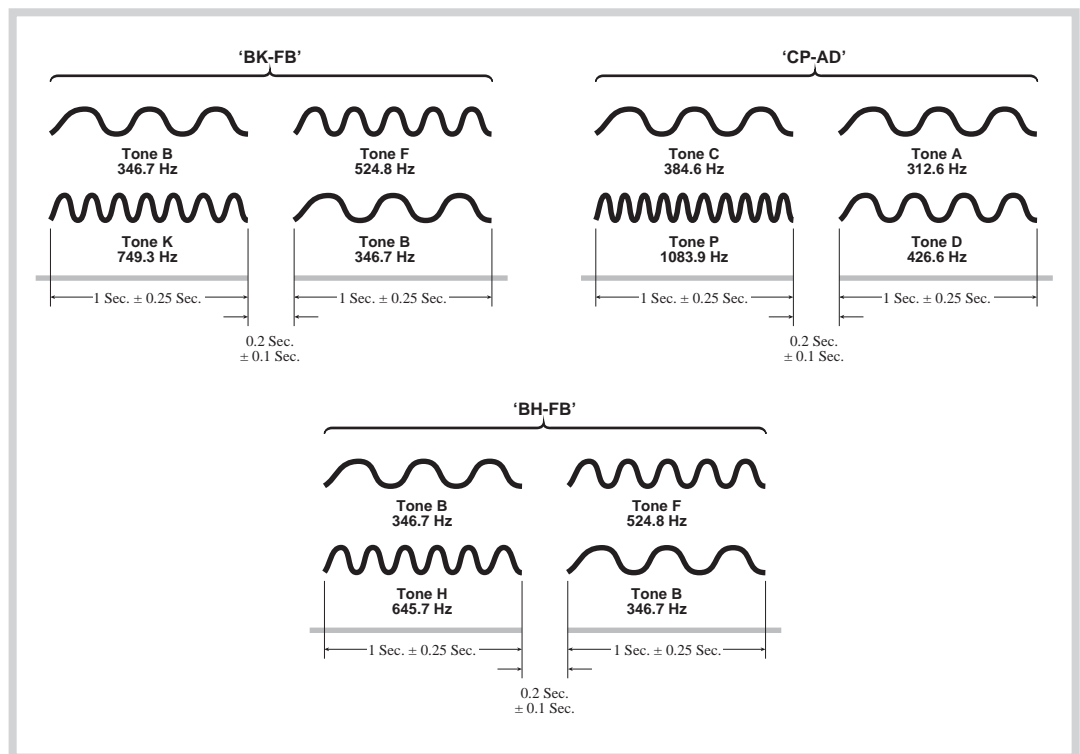

C1413

Fig. B-4 Diagram of SELCAL tones timing

The simulated SELCAL signal

This is an RF carrier amplitude-modulated with dual tones as described above. The Service Monitor SELCAL display screen and menu gives a digital readout of the parameters relating to the simulated signal, with the selected call sign centralized on the display in double size letters. The soft key menu allows call signs and other parameters to be adjusted either directly or by using the data input keys.

Avionics system operation

The System mode of operation is activated by pressing the blue [SYSTEM] key.

If any of the cellular or trunked radio test systems are fitted, the Cellular/Avionics selection screen will be displayed. See Fig. B-5 Cellular/Avionics selection menu. Pressing one of the Avionics test keys - [SELCAL], [Marker Beacon], [ILS] or [VOR] -will cause the selected test screen to be displayed.

If a cellular or trunked radio test system is currently selected, pressing the blue [SYSTEM] key *will not* display the Cellular/Avionics selection screen. Select NO SYSTEM on the SYSTEM SELECTION MENU, then press the blue [SYSTEM] key.

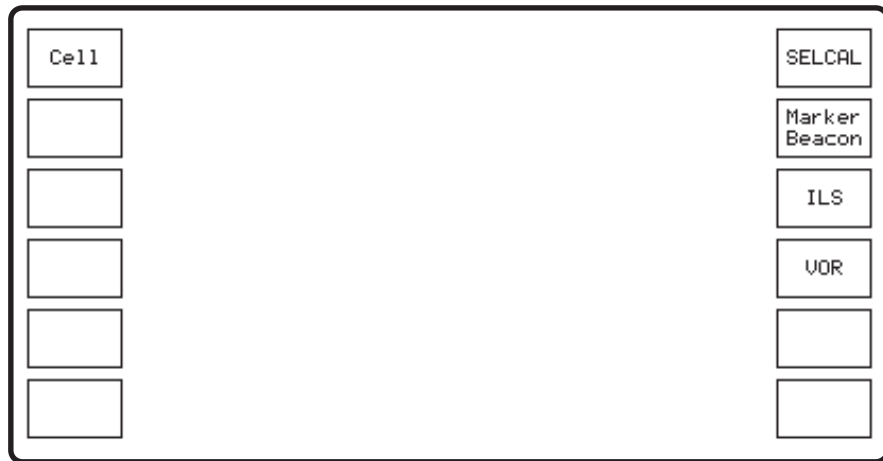

B3220

Fig. B-5 Cellular/Avionics selection menu

If a cellular or trunked radio test systems is not fitted, pressing the blue [SYSTEM] key will display the AVIONICS SYSTEM top level screen and menu. See Fig. B-6.

Selection of the required function is by pressing the appropriate soft key.

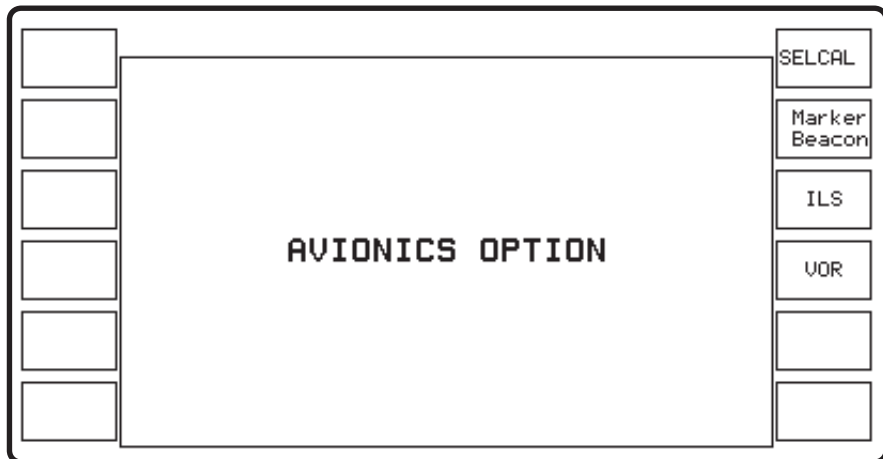

B1788

Fig. B-6 Avionics System top level screen and menu

Pressing the [Return] key on the top level screen of the function will display the AVIONICS OPTION screen. A different Avionics test function can then be selected.

To leave the Avionics mode, select one of the other test modes, i.e. [Tx TEST], [Rx TEST] etc.

RF frequency and level

The RF frequency and RF level for each of the Avionics modes is set in the same way as for the RX test and Dx test modes. After selecting the parameter to be changed, a new value can be entered using the data input keys or the current value can be adjusted using the variable control.

The RF level can be displayed in dBm, in Volt (V, mV or μ V) or in dB μ V by using the appropriate terminator key.

When displayed in volts or dB μ V, the RF level can be given as PD or EMF by making the appropriate setting on Help/Setup page 1. The EMF or PD flag will be shown against the RF Level setting.

ILS

Selecting *[ILS]* displays the screen and menu shown in Fig. B-1.

The ILS localizer transmitters and glideslope transmitters are similar, but independent, devices and the on-board receivers associated with them can be tested individually.

The Service Monitor ILS GENERATOR menu provides instant selection of test signals for either receiver.

Modulation signal output

The modulation signal applied to the ILS carrier is available at the AF OUTPUT connector. The signal level at the connector cannot be set independently of the modulation settings on the screen.

The output level is in the order of 200 mV when the modulation levels are at the default settings.

Selecting localizer or glideslope testing

Press the *[Loc]* key to select the Localizer screen and menu shown in Fig. B-1; press the *[G.S.]* key to select the Glideslope screen and menu.

The similarities of the two functions are obvious from the screens.

For localizer receiver testing:-

- Deviations from track, left and right.
- Carrier frequency in the band 108.10 to 111.95 MHz.
- Voice/ident signal facility.

For glideslope receiver testing:-

- Deviations from glideslope; above and below
- Carrier frequency in the band 329.15 to 335.00 MHz.
- No voice/ident facility.

Setting the RF frequency

The RF frequency of the localizer test signal can be set to any of the allocated frequencies within the range 108.10 to 111.95 MHz. The RF frequency of the glideslope test signal can be set to any of the allocated frequencies within the range 329.15 to 335.00 MHz.

Pressing the *[RF freq]* key will highlight the 'RF Freq:' legend on the display and allow the indicated frequency to be changed by using the variable control, or by using the data keys to enter a new value.

If the entered frequency is not an allocated frequency, the test set will select the nearest frequency to it from the table.

The *FREQ* [\uparrow] or [\downarrow] increment keys can be used to change the RF frequency without selecting *[RF freq]*.

Each localizer frequency increment is paired with a specific glideslope frequency. See ILS frequency pairing, on page B-4.

Note With the localizer screen displayed, using the **FREQ** [\uparrow] or [\downarrow] increment keys will step the carrier frequency up or down to the next allocated localizer frequency. The corresponding glideslope frequency will be set if the glideslope screen is selected

With the glideslope screen displayed, using the **FREQ** [\uparrow] or [\downarrow] increment keys will step up or down the localizer frequency table, but with the glideslope frequency displayed.

Setting the RF level

To change the RF level first press the *[RF Level]* key, then enter the required level using the data entry keys or use the variable control to adjust the displayed frequency. See *RF frequency and level* on page B-8.

Setting the SDM (Sum of Depth of Modulation) level

The position indication on the ILS receiving equipment is determined by measurement of the difference between the modulation depth of the 90 Hz tone and the modulation depth of the 150 Hz tone. Localizer transmission specifications call for 20% modulation levels for each tone giving an SDM value of 40%. Glideslope transmissions require 40% modulation for each tone, giving an SDM level of 80% modulation.

These levels are default settings for the Service Monitor and are always called up when the *[Loc]* or *[G.S.]* keys are pressed.

To change the SDM level press the *[SDM]* key to show 'SDM' in reverse video. Either key in the digits of the percentage value using the data entry keys and the % terminator key or use the variable control knob to set the new level.

The maximum SDM which can be set when localizer test is selected is 50 %. When glideslope is selected, the maximum SDD level is 90 %.

Setting the DDM and selecting Fly Right / Fly Left / Fly Down / Fly Up indications

To test the indicating functions of an ILS receiver, the difference in depth of modulation of the two tones must be varied.

When the 90 Hz tone predominates the indicator will show 'Fly Right' or 'Fly Down'; when the 150 Hz tone predominates the indicator will show 'Fly Left' or 'Fly Up'.

On the ILS displays of the Service Monitor, a digital read-out of the DDM level is shown in the left half of the display and a graphical indication on the right.

The DDM level of the test signal can be set, changed or varied as required.

Using the [DDM] key

Pressing the *[DDM]* key will highlight the DDM legend on the display. A new level can be entered using the data input keys and the [%] terminator key or by adjusting the value by using the variable control.. The new level will be shown on the display and the graphical indication will adjust.

Pressing the *[Fly Lft/Rt]* key (or the *[Fly Up/Dn]* key) will change the relative depth of the modulation to simulate 'Fly left' or 'Fly right' (or 'Fly up' or 'Fly down') conditions.

The *[Supp Tone]* key allows each tone to be suppressed to simulate the Beam Lost' flag alarm. Repeated presses will step through the following sequence:-

- 90 Hz tone suppressed
- 150 Hz tone suppressed, 90 Hz tone restored
- 150 Hz tone restored. (neither tone suppressed)

Using the **[Preset DDM]** key

A choice of four preset DDM levels is available by pressing the *[Preset DDM]* key. These are shown in the following table. The *[Fly Lft/Rt]* key (or the *[Fly Up/Dn]* key) and the *[Supp Tone]* key are used as described above.

Preset DDM levels (with corresponding μ A values)

Localizer				
DDM	0	4.6%	9.3%	15.5%
μ A	0	45	90	150
Glideslope				
DDM	0	4.5%	9.1%	17.5%
μ A	0	39	78	150

As well as showing the DDM value as a percentage, the Service Monitor display shows a μ A value.

Using the localizer Ident facility

To simulate the localizer ident signal press the *[Ident]* key on the ILS localizer menu. A tone of approximately 1020 Hz is applied to the carrier frequency.

The depth of modulation can be changed by first pressing the *[AM Depth]* key and then entering the required level using the data entry keys and the [%] terminator key or by adjusting the value using the variable control.

The localizer position signals from the Service Monitor are disabled when the Ident facility is active.

Marker beacon

Selecting the Marker Beacon function displays the marker beacon screen and menu shown in Fig. B-4 on page B-6.

The default simulated Marker Beacon test signal has a 75 MHz carrier, amplitude modulated at 95% with one of three tones; 400 Hz, 1500 Hz or 3000 Hz for outer, middle or inner markers respectively. The RF frequency, RF level, AM depth and AM frequency can be changed as required.

Setting the RF frequency

The RF frequency of the Marker Beacon test signal can be set to any frequency within the range of the RF generator (400 kHz to 1050 MHz).

Pressing the *[RF freq]* key will highlight the 'RF Freq:' legend on the display and allow the indicated frequency to be changed by using the variable control, or by using the data keys to enter a new value.

Setting the RF level

To change the RF level first press the *[RF Level]* key, then enter the required level using the data entry keys or use the variable control to adjust the displayed frequency. See *RF frequency and level* on page B-8.

Selecting the marker beacon tone frequency

When the [Outer Beacon], [Middle Beacon] or [Inner Beacon] key is pressed, the AF generator will set to 400 Hz, 1.5 kHz or 3 kHz respectively. The tone frequency is shown in the display alongside the appropriate marker designation.

The marker tone can be set to a frequency other than one of the three dedicated frequencies. It can be set to any point within the AF generator range (20 Hz to 20 kHz) by first pressing the [AF Freq] key, then using the data entry keys or by using the variable control to adjust the displayed frequency. A standard frequency can be reset by pressing the appropriate beacon soft key.

When the displayed tone frequency is one of the marker frequencies, the appropriate marker designation will also be displayed.

VOR

Selecting the VOR function displays the VOR screen and menu shown in Fig. B-3 on page B-5.

Setting the RF frequency

The RF frequency of the VOR test signal can be set to any 50 kHz increment within the VOR range of 108 MHz to 118 MHz.

Attempting to set to a frequency outside the VOR range, or not at a precise 50 kHz increment within the range, will cause the carrier to be set to the closest allowable frequency to it.

Pressing the [RF freq] key will highlight the 'RF Freq:' legend on the display and allow the indicated frequency to be changed by using the variable control, or by using the data keys to enter a new value.

The \uparrow or \downarrow increment keys can be used to change the RF frequency without selecting [RF freq].

Setting the RF level

To change the RF level first press the [RF Level] key, then enter the required level using the data entry keys or use the variable control to adjust the displayed frequency. See *RF frequency and level* on page B-8.

Setting the subcarrier depth

The depth of modulation of the RF carrier by the 9960 kHz subcarrier is set by first pressing the [Sub Depth] key and then entering the required value using the data keys and the [%] terminator key or by adjusting the value by using the variable control.

The range of modulation depth available is 0 to 99%.

The depth of modulation of the subcarrier and the depth of modulation of the variable phase 30 Hz signal can be locked to maintain the same value. This is achieved by pressing the [Lock Sub/Ref] key which will display the legend 'Ref/Sub Lock' in reverse video and cause both modulation depths to set to the value of the last modulation depth set. By keying in a new value or by adjusting the modulation depth using the variable control, both levels will change.

Setting the 30 Hz reference tone modulation level

The depth of modulation of the RF carrier by the 30 Hz reference signal is set by first pressing the [Ref Depth] key and then entering the required level of modulation using the data entry keys and the [%] terminator key or by adjusting the value using the variable control.

The range of modulation depth available is 0 to 99%.

The subcarrier and reference tone modulation depth can be locked as described above.

Using the variable bearing facility

The phase relationship between the 30 Hz reference signal and the 30 Hz fixed signal from the subcarrier can be varied with a resolution of 0.1° by using the variable control. The graphic 'bearing indicator' in the display will show the current bearing and a digital read-out is also given in degrees.

Using the Bearing Left and Bearing Right facility

The *[Bearing Left]* and *[Bearing Right]* keys step the bearing in the selected direction through each 10° point.

Using the Bearing To/From facility

VOR indicators can show the bearing to and from the beacon being received. Pressing the *[Bearing To/From]* key cause the indication on the Service Monitor display to change by 180° and show either Bearing to Beacon or Bearing from Beacon as appropriate.

Using the Automatic Increment bearing facility

The Automatic Increment Bearing facility produces a changing signal that sweeps through 360°.

With Bearing to Beacon selected, pressing the *[Aut Inc Bearing]* key will set the bearing to 0.0° and then step up to 360.0° in 1° increments.

With Bearing from beacon active, pressing the *[Aut Inc Bearing]* key will set the bearing to 360.0° and then step down to 0.0° in 1° increments.

To stop the bearing incrementing, press the *[Bearing]* key.

Pressing any of the other bearing option soft keys will stop the bearing incrementing, but will also perform their own function.

Using the VOR Ident facility

To simulate the VOR ident signal select the *[Ident]* key within the VOR menu. A tone of approximately 1020 Hz is applied to the carrier frequency.

The depth of modulation can be changed by first pressing the *[AM Depth]* key and then entering the required level using the data entry keys and the [%] terminator key or by adjusting the value using the variable control. The VOR 30 Hz reference tone and 30 Hz subcarrier tone are both disabled while producing the ident signal.

SELCAL

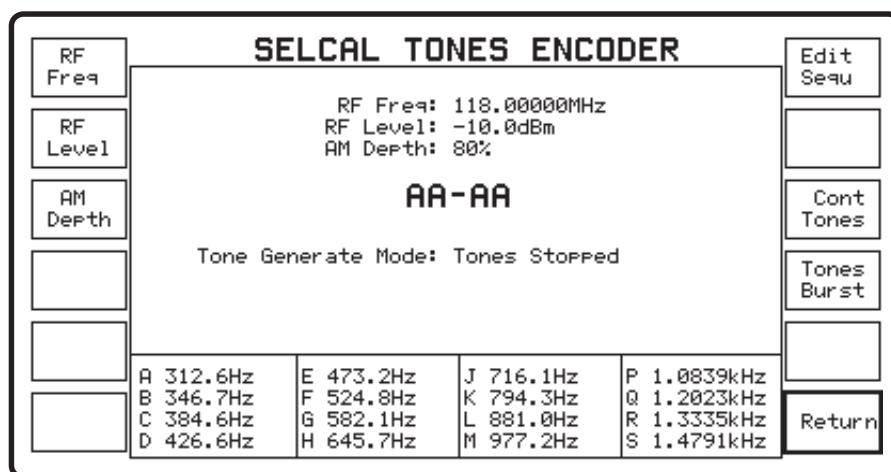

B5150

Fig. B-7 SELCAL screen and menu

Selecting the SELCAL function displays the SELCAL screen and menu. The tone sequence currently set up is shown in the center of the display in large upper-case letters.

The test signal is an amplitude modulated RF carrier, set to the required frequency, level and modulation depth. The selected tone sequence can be applied as a continuous reoccurring signal or as a one shot tone burst

Setting the RF frequency

The RF frequency of the SELCAL test signal can be set to any frequency within the range of the RF generator (400 kHz to 1050 MHz).

Pressing the *[RF freq]* key will highlight the 'RF Freq:' legend on the display and allow the indicated frequency to be changed by using the variable control, or by using the data keys to enter a new value.

Setting the RF level

To change the RF level first press the *[RF Level]* key, then enter the required level using the data entry keys or use the variable control to adjust the displayed frequency. See *RF frequency and level* on page B-8.

Setting the AM depth

The depth of modulation of the RF carrier is set by first pressing the *[AM Depth]* key and then entering the required value using the data keys and the [%] terminator key or by adjusting the value using the variable control.

The range of modulation depth available is 0 to 99%.

Setting the tone sequence

The tone burst is made up of two dual tone pulses as shown in Fig. B-4 tone pulse format and timing diagram on page B-6.

To select the frequency of each tone in the burst the *[Edit Sequ]* soft key is pressed to display the edit sequence menu. From this menu, each tone is selected by pressing the *[↑]* or *[↓]* key to cause the code letter reverse video cursor to scroll through the list of frequencies and then pressing the *[Enter]* key. The first letter in the first pair of letters will change to the selected letter. Repeating the above procedure will change the second letter of the first pair. Then the first letter of the second pair and finally the last letter of the second pair. Further repeats will cause the first letter of the first pair to change again and so on.

Activating the tone burst

The RF signal is present at the selected RF output connector at all times when the 'SELCAL' function is selected.

To start a continuous sequence of tones press the *[Cont Tones]* key.

To start a one shot tones burst press the *[Tones Burst]* key.

To stop a continuous sequence of tones press the *[Tones Burst]* key; the sequence will stop after one tone burst.

ILS localizer/glideslope pairings

The following tables show the pairings of ILS localizer and glideslope transmitter frequencies. The first table is in order of increasing localizer frequency, the second in order of increasing glideslope frequency.

ILS frequency pairings.

Localizer (MHz)	Glideslope (MHz)	Glideslope (MHz)	Localizer (MHz)
108.10	334.70	329.15	108.95
108.15	334.55	329.30	108.90
108.30	334.10	329.45	110.55
108.35	333.95	329.60	110.50
108.50	329.90	329.75	108.55
108.55	329.75	329.90	108.50
108.70	330.50	330.05	110.75
108.75	330.35	330.20	110.70
108.90	329.30	330.35	108.75
108.95	329.15	330.50	108.70
109.10	331.40	330.65	110.95
109.15	331.25	330.80	110.90
109.30	332.00	330.95	111.95
109.35	331.85	331.10	111.90
109.50	332.60	331.25	109.15
109.55	332.45	331.40	109.10
109.70	333.20	331.55	111.15
109.75	333.05	331.70	111.10
109.90	333.80	331.85	109.35
109.95	333.65	332.00	109.30
110.10	334.40	332.15	111.35
110.15	334.25	332.30	111.30
110.30	335.00	332.45	109.55
110.35	334.85	332.60	109.50
110.50	329.60	332.75	111.55
110.55	329.45	332.90	111.50
110.70	330.20	333.05	109.75
110.75	330.05	333.20	109.70
110.90	330.80	333.35	111.75
110.95	330.65	333.50	111.70
111.10	331.70	333.65	109.95
111.15	331.55	333.80	109.90
111.30	332.30	333.95	108.35
111.35	332.15	334.10	108.30
111.50	332.90	334.25	110.15
111.55	332.75	334.40	110.10
111.70	333.50	334.55	108.15
111.75	333.35	334.70	108.10
111.90	331.10	334.85	110.35
111.95	330.95	335.00	110.30

Index

A

AC power supply input.....	3-8
Acceptance tests	5-2
Accessory connector, front panel	3-6
Accessory port, rear optional.....	3-101
Accessory socket connections	2-7
Accessory socket logic	2-8
AF GEN OUT,connector.....	3-6
AF input coupling option.....	3-7
AF measuring circuits.....	4-15
AF TEST mode.....	3-63
AF testing	1-6
Airflow	2-2
AM Depth, SELCAL.....	B-13
Attenuator, switched.....	4-10
Attenuators, external.....	3-34
Audio distortion measurement, Rx test	3-65
Audio generator set-up	3-26
Audio generators	4-7, 4-15
Audio level	3-13
Autotune	3-20, 3-21
Avionics General Description	B-2
Avionics system.....	B-1
Avionics Test Operation.....	B-7

B

Bail arm handle.....	2-3
Bandwidth filters	4-11
Bearing Left/Right.....	B-12
Bearing To/From	B-12
Bearing Variable, VOR	B-11
Bearing, VOR Automatic Increment	B-12
Block diagram	4-1
Broadband power meter	4-9

C

Carrier Frequency VOR	B-11
Cellular radio-telephone systems.....	1-5
Cellular radio-telephones.....	1-3
Clock, real time	3-99
Connections, remote control.....	2-8
Connections, RF and AF	2-6
Connections, RS232	2-8
Connectors, rear panel.....	3-8
Connectors, RF input and output.....	3-5
Controls, rear panel	3-8
Conventions for key labelling	ii
Cooling fan	3-9

D

Data generator	4-8
Date and time stamping.....	3-99
DC supply input	3-8
DDM Level	
Glideslope	B-9
Localiser	B-9
De-emphasis filter	4-12
Demodulated signal output.....	3-8
Demodulation options set-up	3-23
Demodulation settings, look and listen	3-61
Demodulator, AM	4-11
Demodulator, FM	4-11
Directional power heads.....	A-1
Directional power measurement.....	3-22
Directional power measurements	3-28
Disconnecting device	2-3
Display	4-3
Display hold	3-7
Display screen	3-4
Distortion measurement, transmitter audio	3-24
Distortion/SINAD filter.....	4-12
DUPLEX	3-17
Duplex testing	1-4, 3-53
Dx TEST mode	4-16

E

Electrical Hazards	v
External attenuators.....	3-34
External attenuators, RF power	3-12, 3-42

F

Facilities	1-2
Filter, distortion/SINAD.....	4-12
Filters, fan	2-2
Fire Hazards	vi
Fitting batteries.....	2-6
Fly Down.....	B-9
Fly Left.....	B-9
Fly Right.....	B-9
Fly Up	B-9
Frequency changer/mixer, first	4-10
Frequency changer/mixer, second.....	4-10
Frequency changer/mixer, third	4-11
Frequency Pairing, ILS	B-4
Frequency setting, automatic.....	3-21
Frequency standard, external.....	3-8
Front panel layout	3-4
Fuses.....	2-3

G

General Description, Avionics B-2
 General information..... A-1, 1-1
 Getting started 3-9
 Glideslope signal B-3
 Glideslope testing B-8
 GPIB address 3-14
 GPIB connections 2-9

H

Hard copy 3-100
 Harmonic analysis, RF 3-22
 Hold display 3-7

I

IF circuits 4-10
 IF signal output 3-8
 ILS Frequency Pairing; B-4
 ILS frequency pairings table B-14
 ILS menu B-8
 ILS Testing B-8
 Incremental adjustments 3-68
 Incremental adjustments, spectrum analyzer 3-69
 Incremental keys, duplex test mode 3-6
 Incremental keys, spectrum analyzer mode 3-6
 Input power, maximum 3-20
 Input switching 4-9
 Installation 2-1

K

Key AF input coupling 3-7
 Key, HELP/SETUP 3-7
 Key, SELECT, RF input 3-6
 Keys, blue 3-7, 3-9
 Keys, data input 3-5
 Keys, function 3-5
 Keys, increment adjustment 3-6
 Keys, orange 3-5
 Keys, oscilloscope sweep mode 3-7
 Keys, soft 3-5
 keys, terminator 3-5
 Keys, test mode 3-9
 Keys, test mode select 3-7

L

Lithium batteries vi
 Local operation, returning to 3-7
 Local oscillator, first 4-10
 Local oscillator, second 4-10
 Localiser signal B-3
 Localiser Testing B-8
 Logic lines, setting up 3-102
 Look and Listen 1-6, 3-15, 3-60
 Look and Listen function 4-16
 Loudspeaker 4-16

M

Maintenance, routine 2-11
 Marker Beacon B-10
 Marker Beacon signal B-4
 Marker Beacon Tone Frequency B-11
 Marker Beacons B-4
 Marker, RF transient power 3-30
 Memories, settings/results 3-91
 Memories, set-up/results 3-20
 Memory card, using 3-94
 Menus, test modes 3-9
 Microphone, 'press to talk' 3-20
 Modulation control 4-15
 Modulation distortion 3-36
 Modulation input, external 3-8
 Modulation sources 3-42, 4-7
 Modulators 4-15

N

Naming conventions ii

O

Occupied bandwidth 3-22, 3-33
 Offset frequency setting 3-13
 Omnidirectional radiatorange B-5
 Operation Avionics B-2
 Options and accessories 1-16
 Oscilloscope 3-15
 Oscilloscope, using 3-89
 Overload detection 4-10

P

Parallel printer port option, using 3-100
 Power attenuator, 20 dB 4-9
 Power overload 3-27
 Power requirements 2-3
 Pre-emphasis filter 4-15
 Preparing, for use 2-2
 Printer 3-100

R

Ranging circuits, measurements 4-12
 Real time clock 3-99
 Receiver circuits 4-9
 Receiver test measurements 3-47
 Receiver testing 1-4, 3-39
 Reference level, spectrum analyzer 3-6
 Reference tone VOR B-11
 Remote control connections 2-8
 RF amplifier 4-15
 RF counter 4-12
 RF frequency, SELCAL B-13
 RF generator 4-13
 RF input attenuators, tones mode 3-71
 RF level 3-13
 RF level Marker Beacon B-10
 RF level VOR B-11
 RF level, Localiser B-9
 RF level, SELCAL B-13
 RF power external atten 3-12, 3-42
 RIC 3-86
 RS232 control 1-2
 Rx frequency setting 3-41
 Rx TEST mode 4-13
 Rx=Tx 3-13

S

Safety testing A-2
 Safety testing (routine) 2-12
 SDM Level, Glideslope B-9
 SDM Level, Localiser B-9
 SELCAL signal B-6
 Selective calling tones B-6
 Self tests 2-10
 Setup 3-10
 Setup menu pages 3-10
 Shoulder strap, fitting 2-2
 Signal routing, tones mode 3-71
 Spectrum analyzer 1-3, 1-6, 3-15, 3-55
 Spectrum analyzer mode 4-16
 Spectrum analyzer, setting up 3-56
 Spectrum analyzer, span adjustment 3-6
 SSB input sensitivity 3-23
 SSB transmitter frequency 3-34
 Stores, settings/results 3-91
 Subcarrier depth VOR B-11
 SYSTEMS 3-55
 Systems mode 1-3, 4-17

Systems testing 1-5
 Systems mode 1-3, 4-17
 Systems testing 1-5

T

Technical description 4-1
 Terminator keys 3-5
 Test capabilities 1-2
 Test equipment for Acceptance tests 5-3
 Test mode screens 3-9
 Test modes, using 3-16
 Testing, A F mode 3-63
 Tilt warning vii
 Time and date stamping 3-99
 Time scale, RF transient power 3-30
 Tone Burst SELCAL, Activating B-13
 Tone mode signal routing 3-71
 Tone Sequence, SELCAL B-13
 Tones 3-17
 AF Tone Remote 3-84
 Tones mode 3-70
 Tones mode RF input attenuators 3-71
 Tones, CTCSS 3-77
 Tones, DCS 3-79
 Tones, DTMF 3-81
 Tones, POCSAG 3-85
 Tones, Sequential 3-72
 Tracking generator 1-6
 Tracking generator, spectrum analyzer 3-59
 Transient power analysis, RF 3-22, 3-29
 Transmitter power measurement 3-27
 Transmitter test measurements 3-27
 Transmitter testing 1-3, 3-18
 Trigger level, RF transient power 3-30
 Tx power measurement 3-22
 Tx TEST mode 4-7

V

Ventilation 2-2
 Ventilation fan and filter 2-11
 Visual inspection, new instruments 2-2
 VOR B-5, B-11
 VOR Ident B-10, B-12
 VOR signal B-5

W

Warning, audible and visual 3-27

AEROFLEX INTERNATIONAL LTD. SOFTWARE LICENCE AND WARRANTY

This document is an Agreement between the user of this Licensed Software, the Licensee, and Aeroflex International Limited, the Licensor. By opening this Software package or commencing to use the software you accept the terms of this Agreement. If you do not agree to the terms of this Agreement please return the Software package unopened to Aeroflex International Limited or do not use the software.

1. DEFINITIONS

The following expressions will have the meanings set out below for the purposes of this Agreement:

Add-In Application Software	Licensed Software that may be loaded separately from time to time into the Equipment to improve or modify its functionality
Computer Application Software	Licensed Software supplied to run on a standard PC or workstation
Designated Equipment	the single piece of Equipment upon which the licensed software is installed
Downloaded Software	any software downloaded from an Aeroflex web site
Embedded Software	Licensed Software that forms part of the Equipment supplied by Aeroflex and without which the Equipment cannot function
Licence Fee	the consideration ruling at the date of this Agreement for the use of one copy of the Licensed Software on the Designated Equipment
Licensed Software	All and any programs, listings, flow charts and instructions in whole or in part including Add-in, Computer Application, Downloaded and Embedded Software supplied to work with Designated Equipment

2. LICENCE FEE

The Licensee shall pay the Licence Fee to Aeroflex in accordance with the terms of the contract between the Licensee and Aeroflex.

3. TERM

This Agreement shall be effective from the date hereof and shall continue in force until terminated under the provisions of Clause 9.

4. LICENCE

- 4.1 Unless and until terminated, this Licence confers upon the Licensee the non-transferable and non-exclusive right to use the Licensed Software on the Designated Equipment.
- 4.2 The Licensee may not use the Licensed Software on other than the Designated Equipment, unless written permission is first obtained from Aeroflex and until the appropriate additional Licence Fee has been paid to Aeroflex.
- 4.3 The Licensee may not amend or alter the Licensed Software and shall have no right or licence other than that stipulated herein.
- 4.4 The Licensee may make not more than two copies of the Licensed Software (but not the Authoring and Language Manuals) in machine-readable form for operational security and shall ensure that all such copies include Aeroflex's copyright notice, together with any features which disclose the name of the Licensed Software and the Licensee. Furthermore, the Licensee shall not permit the Licensed Software or any part to be disclosed in any form to any third party and shall maintain the Licensed Software in secure premises to prevent any unauthorised disclosure. The Licensee shall notify Aeroflex immediately if the Licensee has knowledge that any unlicensed party possesses the Licensed Software. The Licensee's obligation to maintain confidentiality shall cease when the Licensed Software and all copies have been destroyed or returned. The copyright in the Licensed Software shall remain with Aeroflex. The Licensee will permit Aeroflex at all reasonable times to audit the use of the Licensed Software.
- 4.5 The Licensee will not disassemble or reverse engineer the Licensed Software, nor sub-licence, lease, rent or part with possession or otherwise transfer the whole or any part of the Licensed Software.

5. WARRANTY

- 5.1 Aeroflex certifies that the Licensed Software supplied by Aeroflex will at the time of delivery function substantially in accordance with the applicable Software Product Descriptions, Data Sheets or Product Specifications published by Aeroflex.
 - 5.2 The warranty period (unless an extended warranty for Embedded Software has been purchased) from date of delivery in respect of each type of Licensed Software is:

Embedded Software	12 months
Add-In Application Software	90 days
Computer Application Software	90 days
Downloaded Software	No warranty
 - 5.3 If during the appropriate Warranty Period the Licensed Software does not conform substantially to the Software Product Descriptions, Data Sheets or Product Specifications Aeroflex will provide:
 - 5.3.1 In the case of Embedded Software and at Aeroflex's discretion either a fix for the problem or an effective and efficient work-around.
 - 5.3.2 In the case of Add-In Application Software and Computer Application Software and at Aeroflex's discretion replacement of the software or a fix for the problem or an effective and efficient work-around.
 - 5.4 Aeroflex does not warrant that the operation of any software will be uninterrupted or error free.
-

6 The above Warranty does not apply to:

- 6.1 Defects resulting from software not supplied by Aeroflex, from unauthorised modification or misuse or from operation outside of the specification.
- 6.2 Third party produced Proprietary Software which Aeroflex may deliver with its products, in such case the third party Software Licence Agreement including its warranty terms shall apply.
- 7 The remedies offered above are sole and exclusive remedies and to the extent permitted by applicable law are in lieu of any implied conditions, guarantees or warranties whatsoever and whether statutory or otherwise as to the software all of which are hereby expressly excluded.

8. INDEMNITY

- 8.1 Aeroflex shall defend, at its expense, any action brought against the Licensee alleging that the Licensed Software infringes any patent, registered design, trademark or copyright, and shall pay all Licensor's costs and damages finally awarded up to an aggregate equivalent to the Licence fee provided the Licensee shall not have done or permitted to be done anything which may have been or become any such infringement and shall have exercised reasonable care in protecting the same failing which the Licensee shall indemnify Aeroflex against all claims costs and damages incurred and that Aeroflex is given prompt written notice of such claim and given information, reasonable assistance and sole authority to defend or settle such claim on behalf of the Licensee. In the defence or settlement of any such claim, Aeroflex may obtain for the Licensee the right to continue using the Licensed Software or replace it or modify it so that it becomes non-infringing.
- 8.2 Aeroflex shall not be liable if the alleged infringement:
 - 8.2.1 is based upon the use of the Licensed Software in combination with other software not furnished by Aeroflex, or
 - 8.2.2 is based upon the use of the Licensed Software alone or in combination with other software in equipment not functionally identical to the Designated Equipment, or
 - 8.2.3 arises as a result of Aeroflex having followed a properly authorised design or instruction of the Licensee, or
 - 8.2.4 arises out of the use of the Licensed Software in a country other than the one disclosed to Aeroflex as the intended country of use of the Licensed Software at the commencement of this Agreement.
- 8.3 Aeroflex shall not be liable to the Licensee for any loss of use or for loss of profits or of contracts arising directly or indirectly out of any such infringement of patent, registered design, trademark or copyright.

9. TERMINATION

- 9.1 Notwithstanding anything herein to the contrary, this Licence shall forthwith determine if the Licensee:
 - 9.1.1 As an individual has a Receiving Order made against him or is adjudicated bankrupt or compounds with creditors or as a corporate body, compounds with creditors or has a winding-up order made against it or
 - 9.1.2 Parts with possession of the Designated Equipment.
- 9.2 This Licence may be terminated by notice in writing to the Licensee if the Licensee shall be in breach of any of its obligations hereunder and continue in such breach for a period of 21 days after notice thereof has been served on the Licensee.
- 9.3 On termination of this Agreement for any reason, Aeroflex may require the Licensee to return to Aeroflex all copies of the Licensed Software in the custody of the Licensee and the Licensee shall, at its own cost and expense, comply with such requirement within 14 days and shall, at the same time, certify to Aeroflex in writing that all copies of the Licensed Software in whatever form have been obliterated from the Designated Equipment.

10. THIRD PARTY LICENCES

The software or part thereof may be the proprietary property of third party licensors. In such an event such third party licensors (as referenced on the package or the Order Acknowledgement) and/or Aeroflex may directly enforce the terms of this Agreement and may terminate the Agreement if the Licensee is in breach of the conditions contained herein.

11. EXPORT REGULATIONS

The Licensee undertakes that where necessary the Licensee will conform with all relevant export regulations imposed by the Governments of the United Kingdom and/or the United State of America.

12. NOTICES

Any notice to be given by the Licensee to Aeroflex shall be addressed to:

Aeroflex International Limited, Longacres House, Six Hills Way, Stevenage, SG1 2AN, UK.

13. LAW AND JURISDICTION

This Agreement shall be governed by the laws of England and shall be subject to the exclusive jurisdiction of the English courts. This agreement constitutes the whole Contract between the parties and may be changed only by memorandum signed by both parties.

© AEROFLEX INTERNATIONAL LTD 2007

**CHINA Beijing**

Tel: [+86] (10) 6539 1166
Fax: [+86] (10) 6539 1778

CHINA Shanghai

Tel: [+86] (21) 5109 5128
Fax: [+86] (21) 5150 6112

FINLAND

Tel: [+358] (9) 2709 5541
Fax: [+358] (9) 804 2441

FRANCE

Tel: [+33] 1 60 79 96 00
Fax: [+33] 1 60 77 69 22

GERMANY

Tel: [+49] 8131 2926-0
Fax: [+49] 8131 2926-130

HONG KONG

Tel: [+852] 2832 7988
Fax: [+852] 2834 5364

INDIA

Tel: [+91] 80 5115 4501
Fax: [+91] 80 5115 4502

KOREA

Tel: [+82] (2) 3424 2719
Fax: [+82] (2) 3424 8620

SCANDINAVIA

Tel: [+45] 9614 0045
Fax: [+45] 9614 0047

SPAIN

Tel: [+34] (91) 640 11 34
Fax: [+34] (91) 640 06 40

UK Burnham

Tel: [+44] (0) 1628 604455
Fax: [+44] (0) 1628 662017

UK Stevenage

Tel: [+44] (0) 1438 742200
Fax: [+44] (0) 1438 727601
Freephone: 0800 282388

USA

Tel: [+1] (316) 522 4981
Fax: [+1] (316) 522 1360
Toll Free: (800) 835 2352

As we are always seeking to improve our products, the information in this document gives only a general indication of the product capacity, performance and suitability, none of which shall form part of any contract. We reserve the right to make design changes without notice.

web www.aeroflex.com

Email info-test@aeroflex.com

November 2005