

Global ATM Modernization and Test Equipment

Contents

- **Regulatory and Standards Organizations** **slide 3**
- **Legacy Air Traffic Control (ATC), TCAS Systems** **slide 10**
- **Cobham AvComm Legacy Test Equipment** **slide 18**
- **Global ATM Modernization** **slide 24**
- **ADS-B 1090 Extended Squitter** **slide 28**
- **ADS-B UAT (Universal Access Transceiver)** **slide 43**
- **Global ADS-B 1090ES** **slide 50**
- **Hybrid Surveillance** **slide 59**
- **Wide Area Multilateration** **slide 71**
- **New Test Equipment to Support ATM Modernization** **slide 77**



Regulatory and Standards Organizations



- A specialized agency of the United Nations
- Codifies the principles and techniques of international air navigation
- Fosters the planning and development of international air transport to ensure safe and orderly growth
- Adopts standards and recommended practices concerning air navigation, its infrastructure, flight inspection, prevention of unlawful interference, and facilitation of border-crossing procedures for international civil aviation
- Headquarters are located in Montreal, Canada

Federal Aviation Administration (FAA)



**Federal Aviation
Administration**

- The national aviation authority of the United States
- Part of the United States Department of Transportation
- Has the authority to regulate and oversee all aspects of American civil aviation

Global ATM Modernization and Test Equipment

Radio Technical Commission for Aeronautics (RTCA)



- Founded as the Radio Technical Commission for Aeronautics in 1935
- Chartered by the FAA to operate Federal advisory committees
- Generates minimum performance standards for CNS/ATM systems and equipment “DO” docs
- Forge recommendations on key aviation policies
- Identifies and develops mitigation on issues affecting air traffic management operations
- RTCA performance standards form the basis for FAA regulatory requirements
- RTCA policy advice informs the FAA’s prioritization and investment decisions
- RTCA tactical advice helps resolve real-world impediments to air transportation

Global ATM Modernization and Test Equipment

EASA



- The European Aviation Safety Agency (EASA) is an agency of the European Union (EU) with regulatory and executive tasks in the field of civilian aviation safety. Based in Cologne, Germany, the EASA was created on 15 July 2003, and it reached full functionality in 2008, taking over functions of the Joint Aviation Authorities (JAA). European Free Trade Association (EFTA) countries have been granted participation in the agency.
- The responsibilities of EASA include to conduct analysis and research of safety, authorising foreign operators, giving advice for the drafting of EU legislation, implementing and monitoring safety rules (including inspections in the member states), giving type-certification of aircraft and components as well as the approval of organizations involved in the design, manufacture and maintenance of aeronautical products.

Global ATM Modernization and Test Equipment

Euro control



EUROCONTROL

- European Organization for the Safety of Air Navigation. Founded in 1960, it is an international organization working for seamless, pan-European air traffic management. EUROCONTROL is a civil organization and currently has 41 member states; its headquarters are in Haren, City of Brussels.
- EUROCONTROL coordinates and plans air traffic control for all of Europe. This involves working with national authorities, air navigation service providers, civil and military airspace users, airports, and other organizations. Its activities involve all gate-to-gate air navigation service operations: strategic and tactical flow management, controller training, regional control of airspace, safety-proofed technologies and procedures, and collection of air navigation charges.

Global ATM Modernization and Test Equipment

European Organization for Civil Aviation Equipment (EUROCAE)



- EUROCAE develops performance specifications and other documents exclusively dedicated to the Aviation community.
- EUROCAE documents are widely referenced as a means of compliance to European Technical Standard Orders (ETSOs) and other regulatory documents.
- As well as detailed test specifications, EUROCAE also produces system performance (Minimum Operational Performance Standards) and guidance documents together with RTCA Inc.
- EUROCAE also works with SAE in the United States.
- EUROCAE documents are also produced in the context of the applicable ICAO standards and are coherent with existing ARINC specifications to ensure global interoperability.



Legacy Air Traffic Control (ATC) and TCAS Systems

Global ATM Modernization and Test Equipment

Primary and Secondary Surveillance Radar

Legacy ATC and TCAS Systems

- Surveillance System utilizing ground based radar
- Primary Surveillance Radar (PSR) skin paints the aircraft
- Secondary Surveillance Radar (SSR) utilizes an interrogation from the ground station at 1030 MHz and a 1090 MHz coded reply from an aircraft transponder providing range, bearing, identification and altitude information.
- Mode S (Selective) provides high air traffic density monitoring and data link capability
- TCAS (Traffic Alert Collision Avoidance System) provides pilot with target awareness up to a range of 30nm and target avoidance directives, based on closing rate. Use 1030/1090 MHz interrogations and replies.

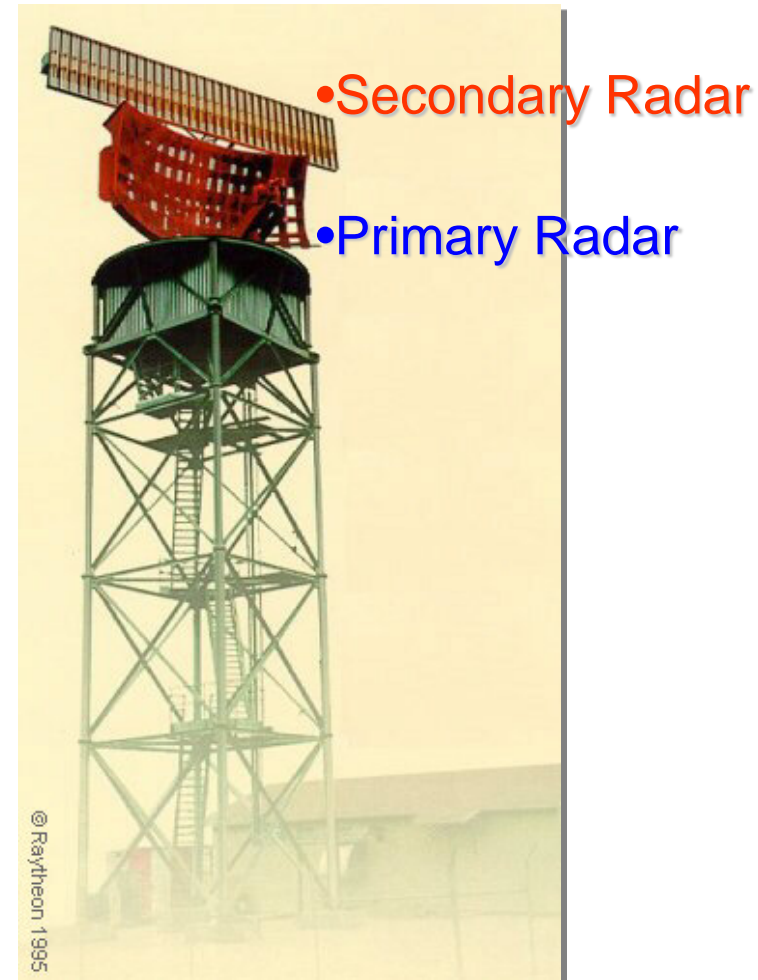

Mode S Transponders and Secondary Surveillance Radar

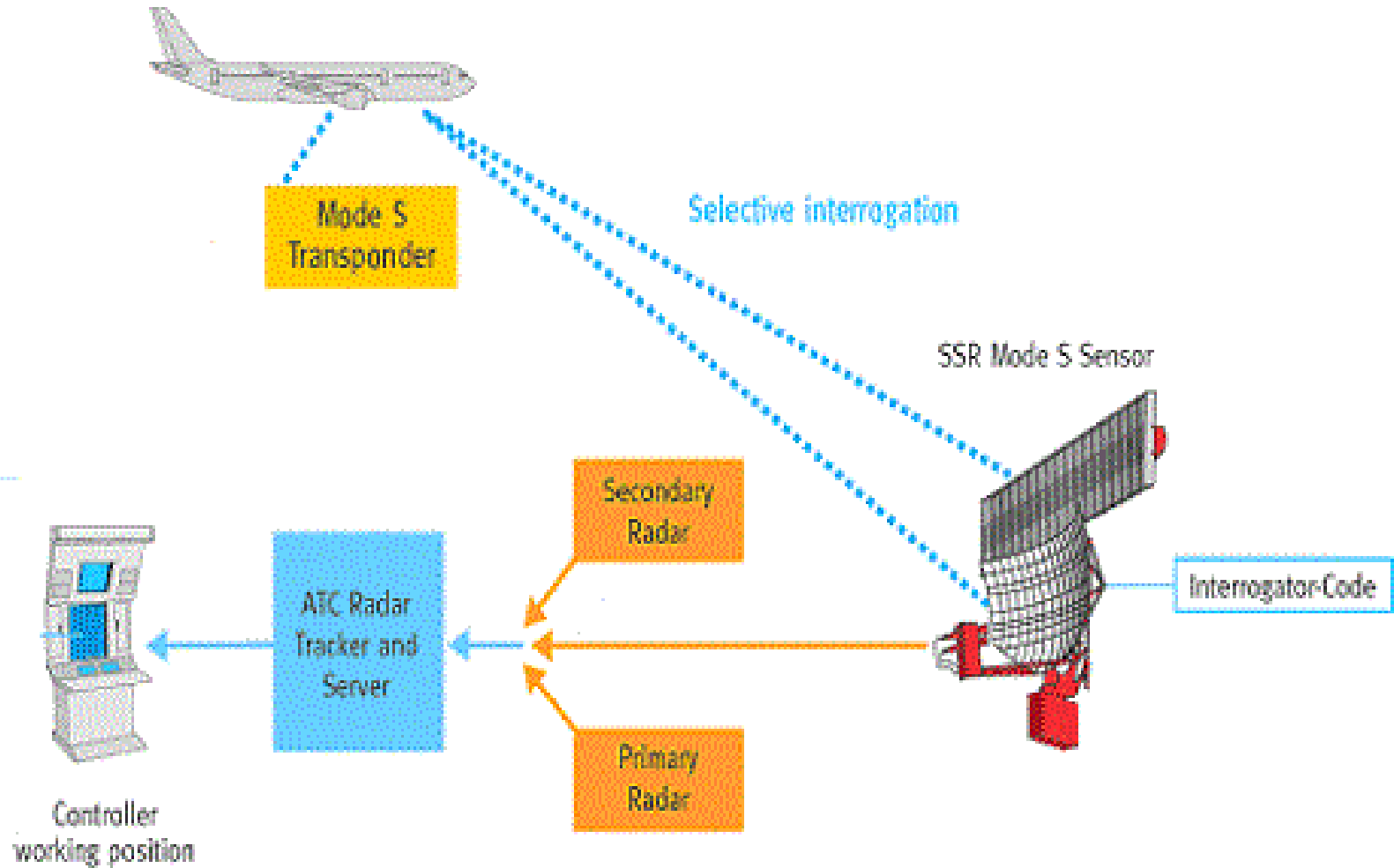

Secondary Surveillance Radar Accuracies

	Standard SSR	Monopulse SSR	Mode S
Replies per scan	20–30	4–8	1
Range accuracy	230 m rms	13 m rms	7 m rms
Bearing accuracy	0.08° rms	0.04° rms	0.04° rms
Height resolution	100 ft (30 m)	100 ft	25 ft (7.6 m)
Garble resistance	poor	good	best
Data capacity (uplink)	0	0	56–1,280 bits
Data capacity (downlink)	23 bits	23 bits	56–1,280 bits
Identity permutations	4,096	4,096	16 million

Note: At 50nm, angular accuracy is about 30m for Monopulse SSR

TCAS II Operation

- TCAS involves communication between all aircraft equipped with an appropriate Transponder (provided the transponder is enabled and set up properly).
- Each TCAS-equipped aircraft interrogates all other aircraft in a determined range about their position using 1030 MHz Modes C and S interrogations.
- The aircraft reply using 1090 Mode reply groups. This interrogation-and-response cycle may occur several times per second.
- The TCAS system builds a three dimensional map of aircraft in the airspace, incorporating their range (garnered from the interrogation and response round trip time), altitude (as reported by the interrogated aircraft), and bearing (by the directional antenna from the response).
- Then, by extrapolating current range and altitude difference to anticipated future values, it determines if a potential collision threat exists.
- TCAS and its variants are only able to interact with aircraft that have a correctly operating Mode C or Mode S transponder. A unique 24-bit identifier is assigned to each aircraft that has a Mode S transponder.

TCAS II Operation (cont)

- TCAS and its variants are only able to interact with aircraft that have a correctly operating Mode C or Mode S transponder. A unique 24-bit identifier is assigned to each aircraft that has a Mode S transponder.
- The next step beyond identifying potential collisions is automatically negotiating a mutual avoidance manoeuvre (currently, manoeuvres are restricted to changes in altitude and modification of climb/sink rates) between the two (or more) conflicting aircraft. These avoidance manoeuvres are communicated to the flight crew by a cockpit display and by synthesized voice instructions.
- A protected volume of airspace surrounds each TCAS equipped aircraft. The size of the protected volume depends on the altitude, speed, and heading of the aircraft involved in the encounter. The next slide provides an example of a typical TCAS protection volume.

TCAS II Protection Volume

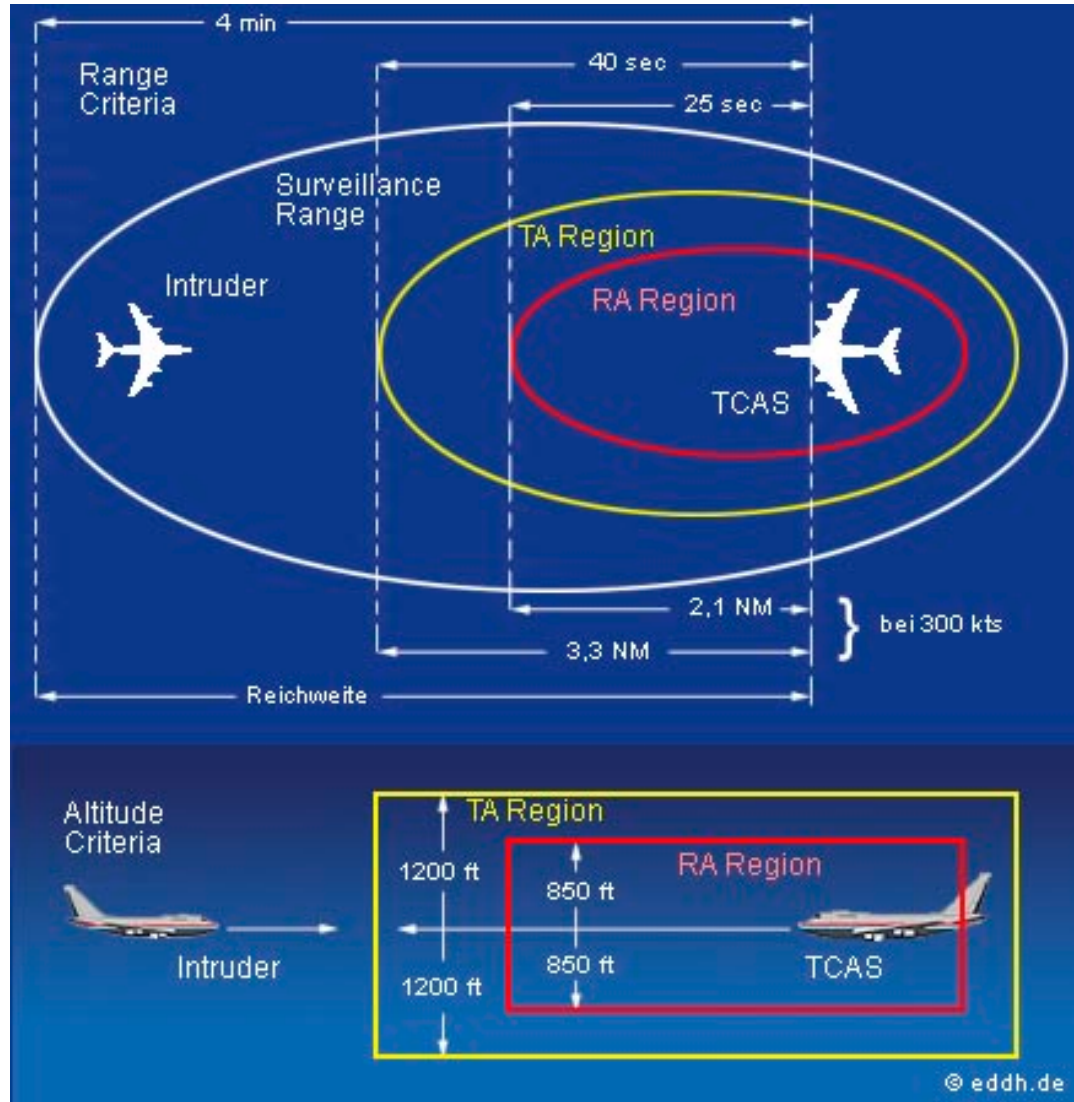

TCAS Display & Target Symbols

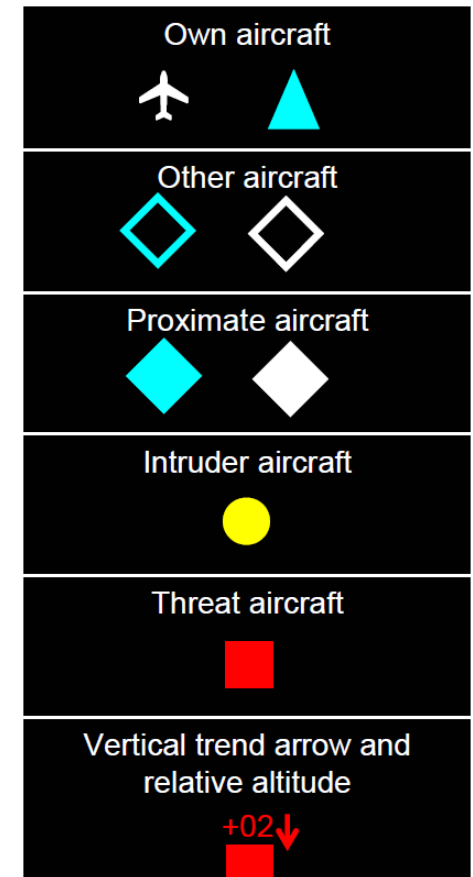
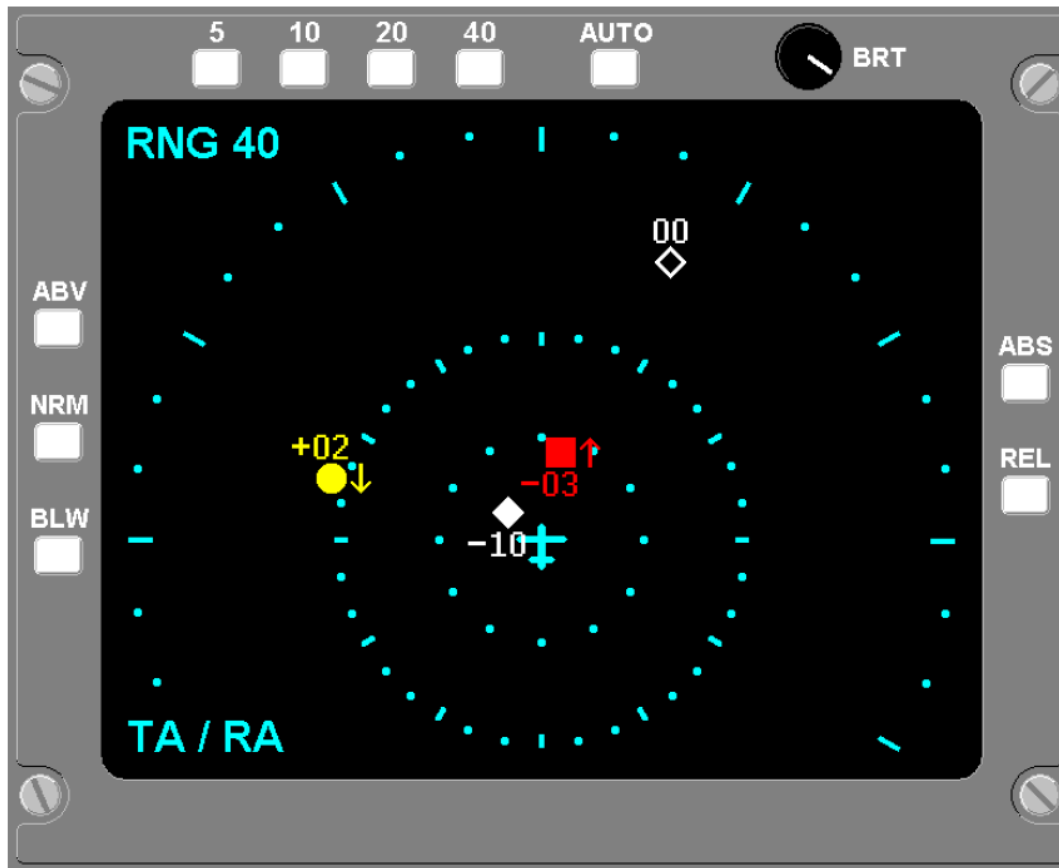



Cobham AvComm Legacy Test Equipment

Legacy Transponder Test Sets

Legacy ATC-1400A/S-1403DL - launched in 1989

Legacy SDX-2000 - launched in 1997

- Both product lines designed for development and test of transponders
- These products had reached the design limit of the hardware associated with each platform:
 - **Not capable of performing tests for DO-260B or DO-282-** Testing under DO-260B and DO-282 would require significant engineering changes to comply with these standards.
 - **Not upgradeable-** No longer under engineering control. The design is fixed at the last release of the software and will not be changed to include any additional capability. Hardware designs will not support new modulation schemes/formats.
 - **Obsolete** – The SDX2000 and the ATC-400A/S-1403DL are no longer being manufactured. Limited legacy support is being provided by a 3rd party calibration supplier.

Legacy Transponder Test Set

SDX-2000

- Color LCD display with touch screen interface ✓
- Control interface for ATE applications GPIB
- Pulses programmable for width, position and amplitude ✓
- Mode S, A and C interrogations DO-181B
- Number of unique interrogations programmable 32
- Supports all uplink/downlink protocols DO-181B
- Extended squitter testing DO-260A
- Two independent RF channels for diversity testing 2
- RF output range 0 to -110 dBm
- RF output accuracy +/- .5 dB
- On/Off ratio >80 dB

Legacy Transponder Test Sets

ATC-1400A/S1403DL

- ATC-1400 Knobs, Switches, LED readouts. S-1403DL Keypad & Monochrome LCD display Hybrid Controls
- Control interface for ATE applications GPIB
- Pulses programmable for width, position and amplitude ✓
- Mode S, A and C interrogations DO-181B
- Number of unique interrogations programmable 1000 Mode S Only
- Supports all uplink/downlink protocols DO-181B
- Extended squitter testing DO-260 (pre change 1)
- Two independent RF channels for diversity testing 2
- RF output range Note 1
- RF output accuracy Note 2
- On/Off ratio >80 dB

Note 1: ATC-1400A Range 0 to -127 dBm S-1403DL Range 20 to -83 dBm

Note 2: ATC-1400A Accuracy 0 to 90dBm +/-2.0dB S-1403DL Accuracy worst case +/-0.72 dBm

The legacy RGS-2000 was launched by JcAIR in 1993

- Designed for the following types of testing:
 - Design verification/Development Engineering Testing
 - To support testing for RTCA DO-185
 - Factory Acceptance/Production End Item Testing
 - Return to Service/Maintenance Testing
- The legacy RGS-2000
 - **Not upgradeable**- The existing design is no longer supported by our engineering department.
 - **Obsolete** – The RGS2000 is out of production due to a significant number of obsolete parts and antiquated design.
 - **Not capable of performing tests for DO-260B or DO-300**- The RGS2000 can not support any additional capabilities due to limited memory space and new modulation schemes/formats that cannot be supported by the current hardware.



Legacy TCAS Test Set

RGS-2000

• Display type	EL with keypad
• Control interface for ATE applications	GPIB
• Pulses programmable for width, position and amplitude	√
• Mode S, A and C targets	DO-185A
• Number of unique targets programmable	30 dynamic 120 static
• Supports all uplink/downlink protocols	No
• Extended squitter testing	No
• ADS-B target simulation	No
• Independent RF channels for scenario simulation	3
• RF output range	-20 to -85dBm
• RF output accuracy	+/-1 dB
• On/Off ratio	>60 dB
• Configuration storage capability	No

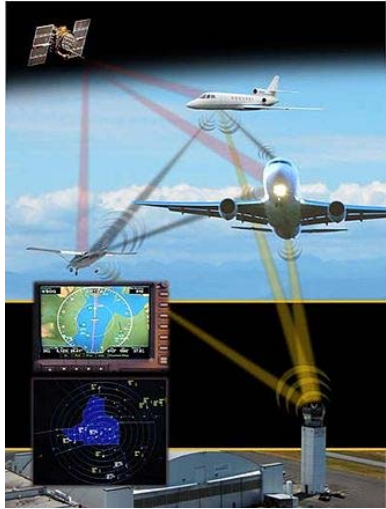

Global ATM Modernization

The move away from ground-based navigation and surveillance

ICAO's Strategic Vision for CNS/ATM Modernization

- To foster implementation of a seamless, global air traffic management system
- System will enable aircraft operators to meet their planned times of departure and arrival
- System will adhere to their preferred flight profiles with minimum constraints and without compromising agreed levels of safety
- Global ATM Modernization efforts are lead by:
 - FAA and NextGen in United States
 - SESAR in Europe
- Soon to follow:
 - Japan and CARATS
 - China, Australia, Russia and Canada



Global ATM Modernization and Test Equipment

FAA NextGen Systems

Present (conventional) system	NextGen system
Ground-based navigation and surveillance	Satellite-based navigation and surveillance
Voice communications	Digital communications
Disconnected information systems	Networked information systems
Diparate, fragmented weather forecast delivery system	Single, authoritative system in which forecasts are embedded into decisions
Airport operations limited by visibility	Operations continue in lower visibility
Air traffic "control"	Air traffic "management"

Global ATM Modernization and Test Equipment

Progression of Mode S Development

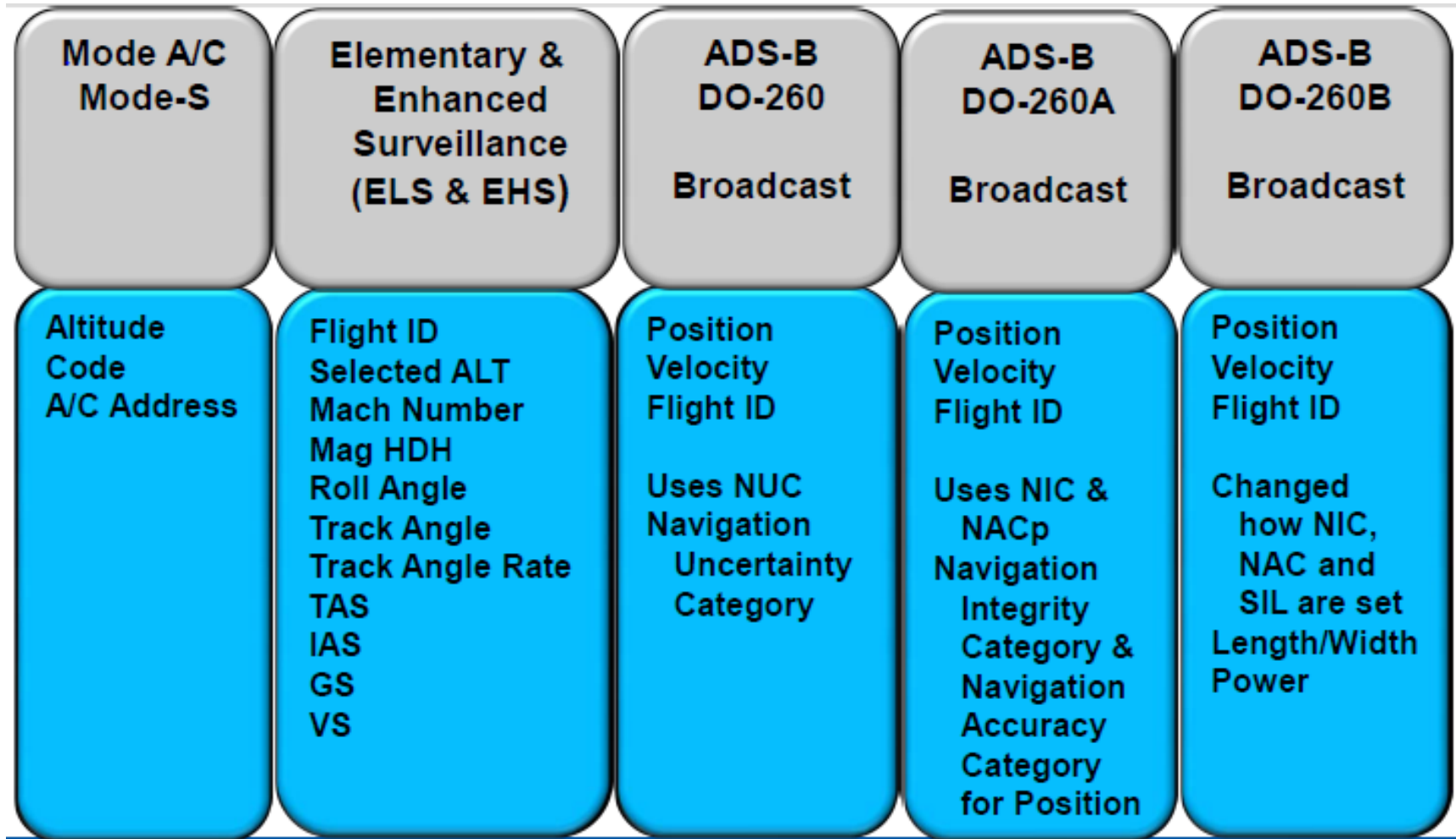



ADS-B 1090ES

Global ATM Modernization and Test Equipment

ADS-B Overview

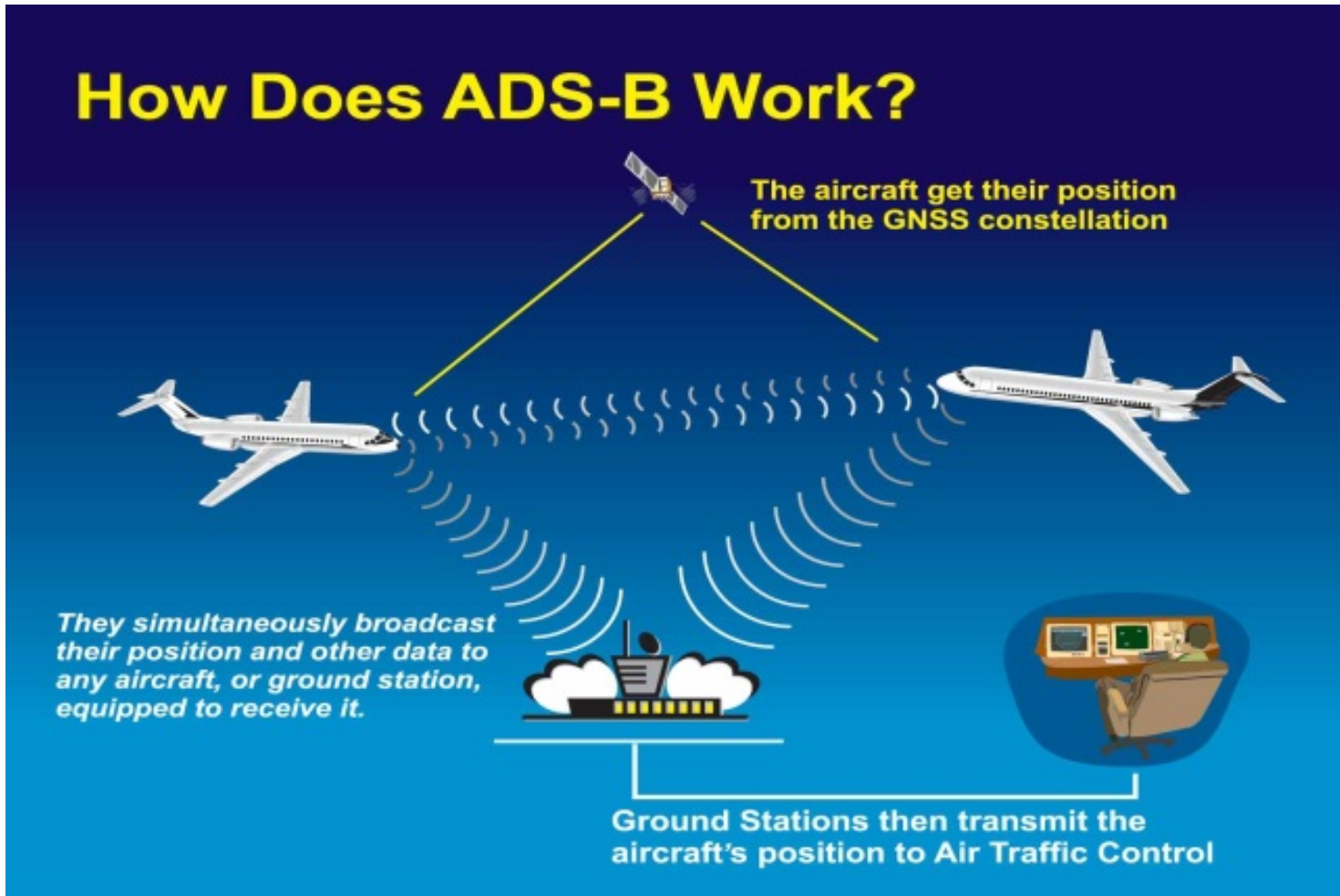

ADS-B Technologies Illustration

ADS-B Overview

- ADS-B enhances safety by making an aircraft visible, real-time, to air traffic control (ATC) and to other equipped ADS-B aircraft
- System requires a high-integrity GPS navigation source and a data link (ADS-B unit)
- ADS-B Out broadcasts position and velocity data twice a second using 1090MHz DF17 Extended Squitters (ES).
- ADS-B Out broadcasts may also be received directly by other aircraft with ADS-B In capability.
- The ADS-B Out broadcasts are also received by ground stations, where the targets are retransmitted (ADS-R) for reception by aircraft with ADS-B In capability. (simplification)
- The ADS-B system can also provide non ADS-B traffic and government generated graphical weather information through TIS-B and FIS-B (UAT only) applications.
- Target Symbols are used to differentiate target types i.e. ADS-B, ADS-R, TIS-B
- Satellite based ADS-B Out will obsolete traditional radar-based ATC (possibly worldwide)

GPS Accuracies Applicable to ADS-B

Horizontal Position Error Histogram: 1 April - 30 June 2014

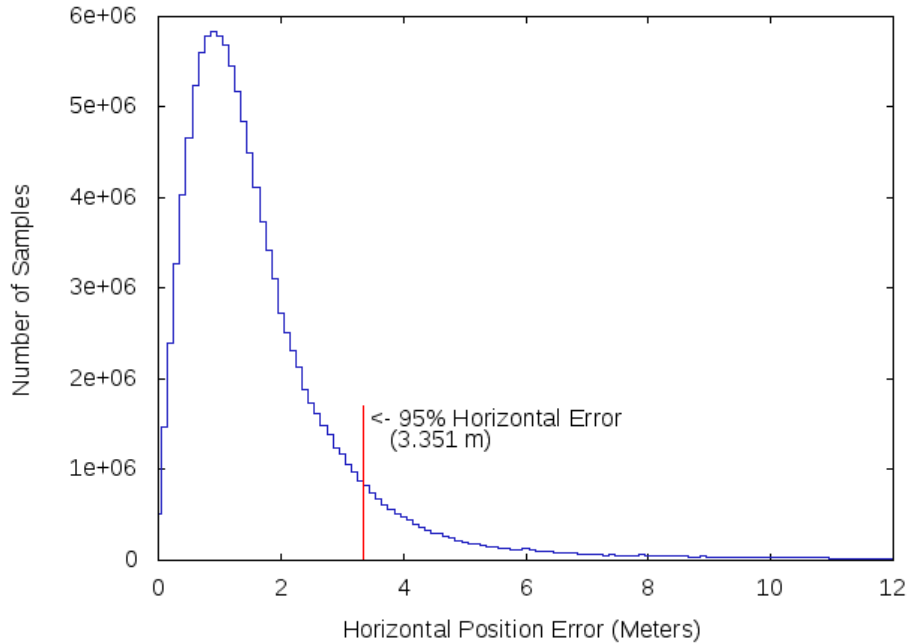

Vertical Position Error Histogram: 1 April - 30 June 2014

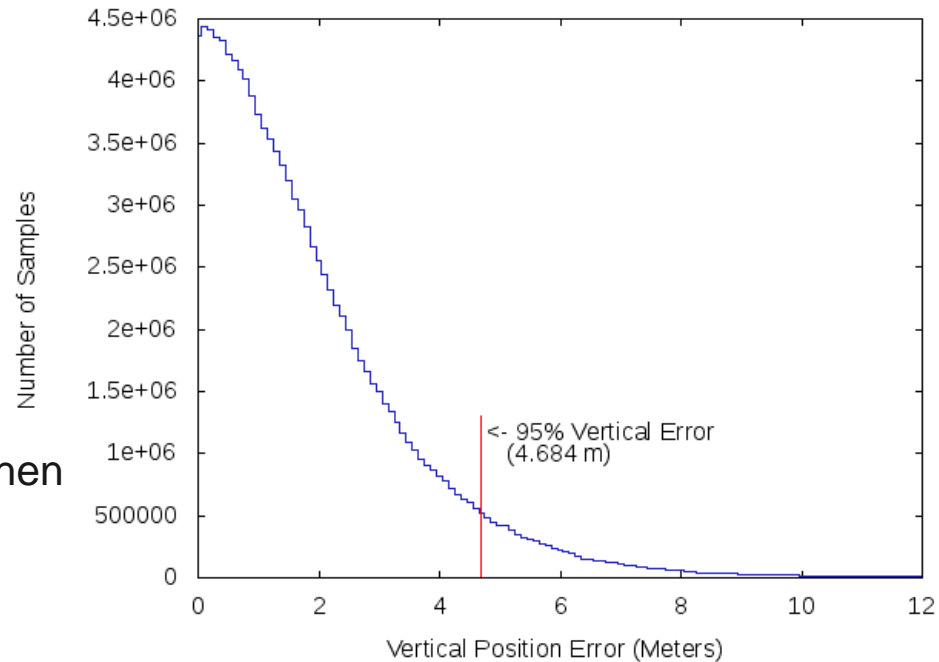

Note: GPS is substantially more accurate when compared with Mode S SSR.

Global ATM Modernization and Test Equipment

Mode S 1090MHz Reply Waveform

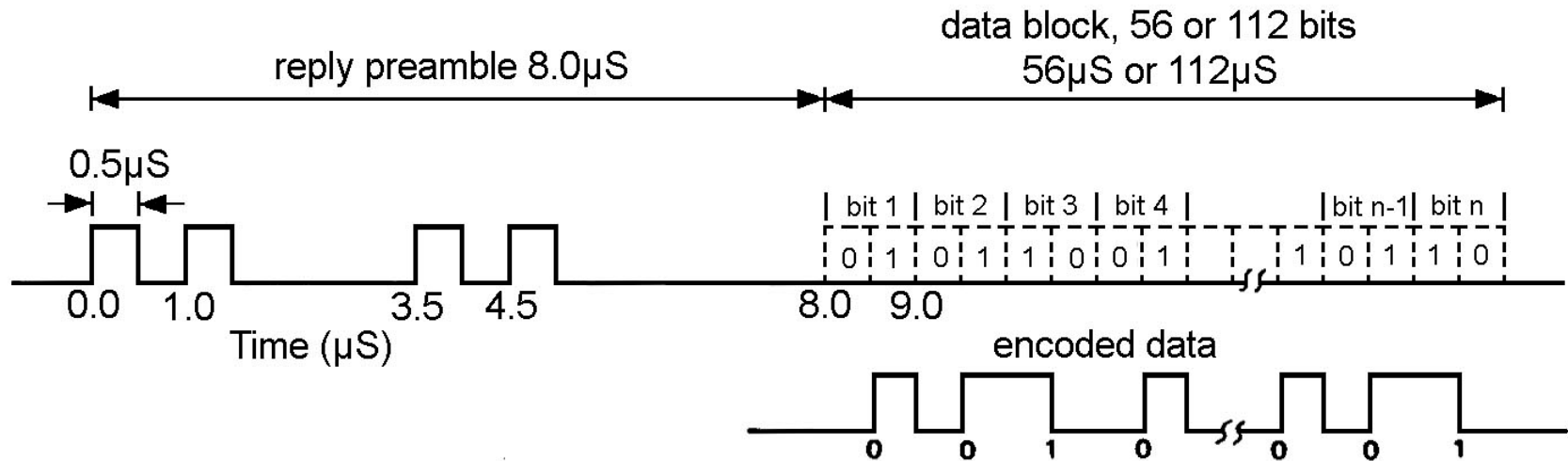

- Pulse Position Modulation (PPM)
- Data Rate 1Mb/s

Global ATM Modernization and Test Equipment

ADS-B Extended Squitter Types

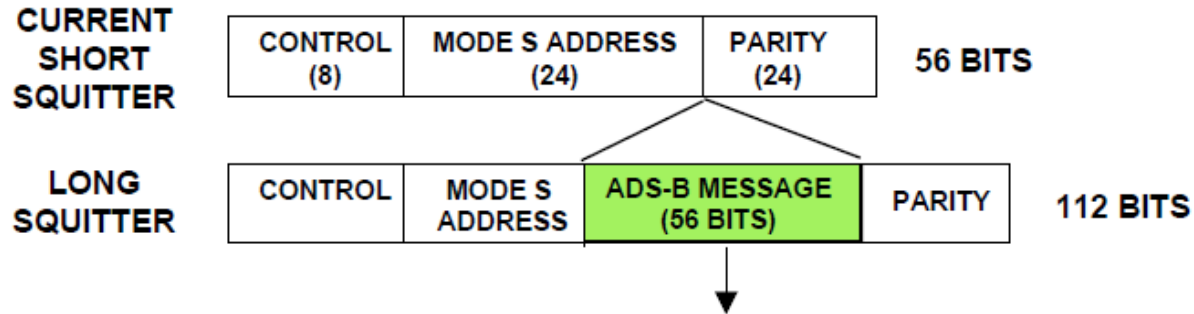

<u>SQUITTER TYPE</u>									<u>BROADCAST RATE</u> <i>(NUMBER/SECOND)</i>
AIRBORNE	POSITION	TYPE	STATUS	ALTITUDE	SPARE	TIME	LAT	LONG	2
	VELOCITY	TYPE	E-W VEL	N-S VEL	TURN RATE	VERT RATE	SPARE		2
SURFACE		TYPE	MOVEMENT	GRD TRACK	SPARE	TIME	LAT	LONG	2
IDENTIFICATION		TYPE	AIRCRAFT CATEGORY		AIRCRAFT CALL SIGN				0.2
EVENT DRIVEN		TYPE	TBD						AS NEEDED

ADS-B, ADS-R, TIS-B Aircraft Block

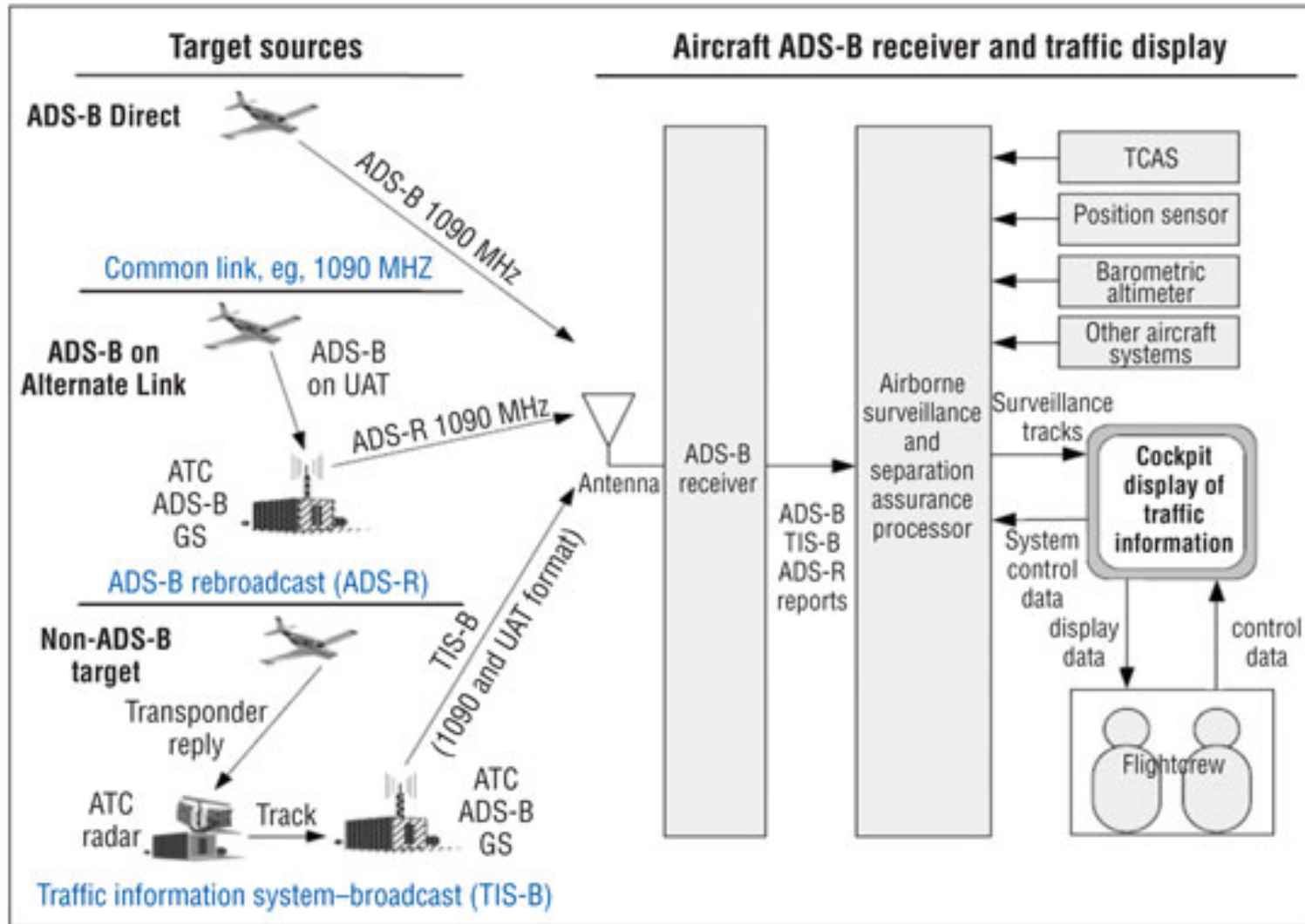

- Ground Stations transmit traffic in two forms which are fundamentally different.
 - TIS-B (Traffic Information Service Broadcast) is essentially ATC's traffic picture obtained from ground based radar surveillance.
 - TIS-B is available in terminal areas, and where ever RADAR services are available. TIS-B traffic does not include ADS-B Out aircraft, but only legacy transponder-equipped aircraft which have been located by ATC secondary surveillance RADAR.
 - Only aircraft with the right kind of ADS-B In equipment receive nearby traffic targets over TIS-B.

- ADS-R (Automatic Dependent Surveillance-Rebroadcast) is a simple repeater.
 - Messages received on 1090 MHz are re-broadcast on 978 MHz, and messages received on 978 MHz are re-broadcast on 1090 MHz. This makes a data-connection between the two ADS-B channels.
 - Only aircraft with the right kind of ADS-B In equipment receive traffic targets over ADS-R.

Global ATM Modernization and Test Equipment

ADS-B, ADS-R, TIS-B Ground Block

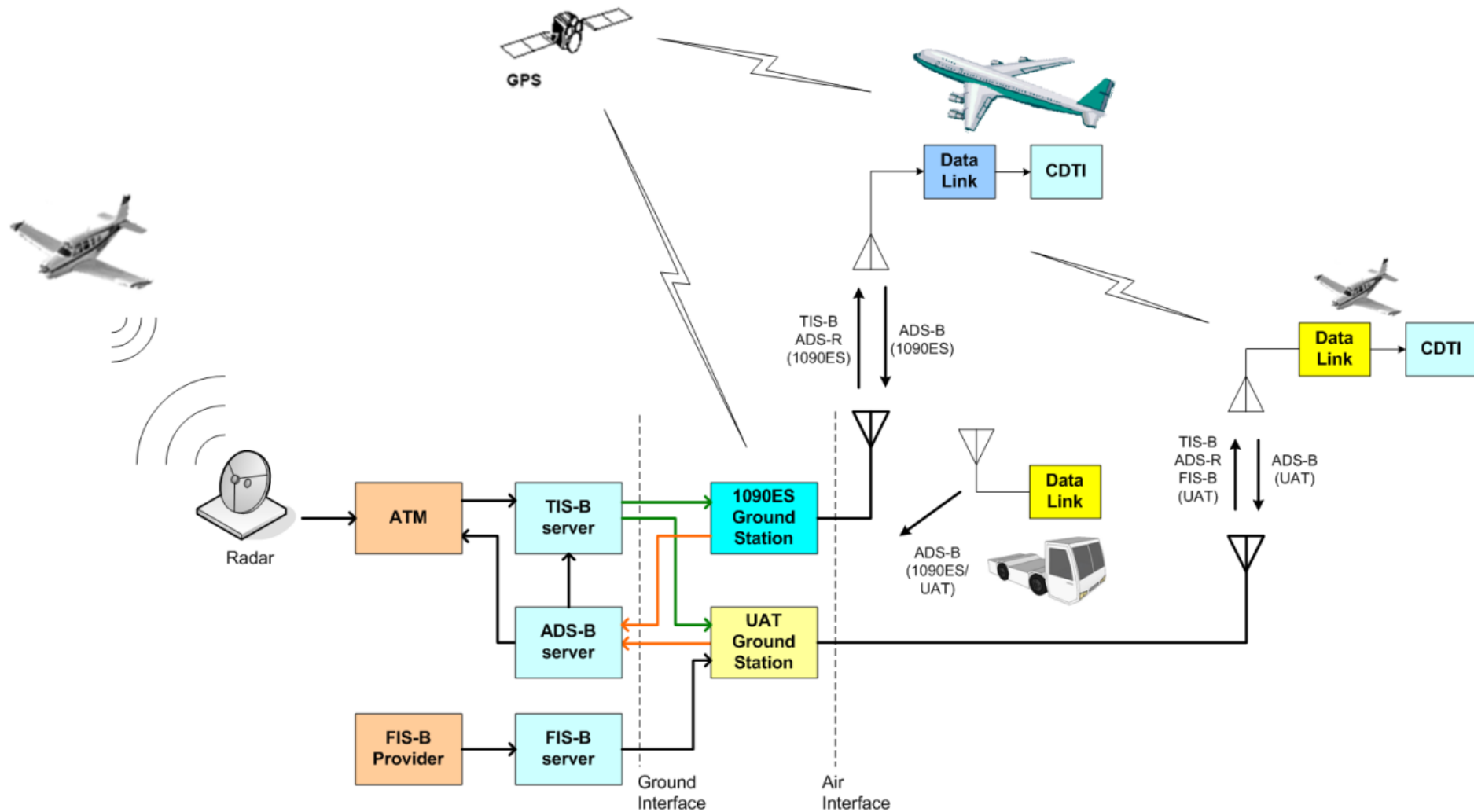

U.S. Mandate

- 800 ADS-B Ground-stations planned
- Federal Regulations dated May 2010 14 CFR 91.225 & 14 CFR 91.227 FAA requires ADS-B transmitters (Out) for all aircraft by January 1, 2020
- Aircraft will have either: 1090 MHz extended squitter (class A airspace) or UAT Transceiver (978MHz) (airspace below 18,000 ft)
- ADS-B will be the backbone of the NextGen ATC system coming online in 2020
- There is no mandate for ADS-B In (which receives data & provides it to in-cockpit displays)
- 14 CFR 91.227 states minimum performance requirements DO-260B for ADS-B

ADS-B Mandates

European Mandate

COMMISSION IMPLEMENTING REGULATION (EU) No 1207/2011 of 22 November 2011 laying down requirements for the performance and the interoperability of surveillance for the single European sky

- Part B: Secondary surveillance radar transponder capabilities referred to in Article 4(3), Article 5(4)(b), (5)(b) and (7), Article 7(2) and Article 8(3)

 - 3. The following data items shall be made available to the transponder and be transmitted by the transponder via Version 2 of the extended squitter (ES) ADS-B protocol in accordance with the formats specified in ICAO document 9871 (2nd edition). U.S. equivalent RTCA DO-260B.
- Original compliance dates Jan. 8, 2015, for new aircraft, with retrofit installations due Dec. 7, 2017.
 - New compliance dates are June 8, 2016, for new aircraft and June 7, 2020, for retrofit

Note: Revised date for retrofits is more closely aligned with the U.S. ADS-B out mandate, which requires the equipment to be operational in aircraft that fly where transponders are currently required, after midnight on Dec. 31, 2019

Rest of World

- **ICAO** Mandatory installation of ADS-B surveillance system in non-radar airspace 2015
Mandatory installation of ADS-B avionics for all aircraft 2020
- **Australia** Installation of 29 ADS-B Ground-stations. Mandatory installation of ADS-B avionics for all aircraft in upper Australian airspace FL290 2013
- **China** ADS-B Technologies, an American company, created one of the largest and most successful ADS-B systems in the world (an 8-station, 350+ aircraft network that spans more than 1,200 NM across Central China). This was also the first UAT installation outside the United States. As of March 2009, more than 1.2 million incident/failure free flight hours have been flown with these ADS-B systems. Implementation of 694 ADS-B ground stations (1090 ES and UAT) nationwide have been planned for 2011-2020.
- **Hong Kong** The Civil Aviation Department (CAD) is approaching operational status for a new network of eight Automatic Dependent Surveillance-Broadcast (ADS-B) ground stations in the Hong Kong flight region. CAD approved Thales to provide its ADS-B ground solutions following a series of stringent acceptance and flight checks to support the International Civil Aviation Organization's (ICAO) regional plan to implement ADS-B throughout the Asia-Pacific region.

Rest of World

- **Canada** – Nav Canada commissioned operational use of ADS-B in 2009 and is now using it to provide coverage of its northern airspace around Hudson Bay, most of which currently has no radar coverage. The service is also being extended to cover some oceanic areas off the east coast of Canada and Greenland. The service is expected to be later extended to cover the rest of the Canadian Arctic, and to the rest of Canada.
- **Iceland** – As of 2010, is in the process of installing ADS-B across the North Atlantic Ocean. The system is made up by 18 ADS-B receiver stations in Iceland, Faroe Islands, and Greenland.
- **United Arab Emirates** – UAE commissioned three operational redundant ADS-B ground stations in early 2009 and is now using ADS-B to provide enhanced coverage of its upper airspace in combination and integrated with conventional surveillance radars.

Global ATM Modernization and Test Equipment

FAA NextGen/SESAR Applicable Standards

- Transponder
 - DO-181E: MOPS for Air Traffic Control Radar Beacon System/Mode Select (ATCRBS/Mode S) Airborne Equipment
 - ED-73E: MOPS Mode S Transponders
- UAT
 - DO-282B: Corrigendum 1, MOPS for Universal Access Transceiver (UAT) Automatic Dependent Surveillance – Broadcast
- TCAS
 - DO-185A,B: MOPS for Traffic Alert and Collision Avoidance System II (TCAS II) Airborne Equipment
 - DO-300: MOPS for Traffic Alert and Collision Avoidance System II (TCAS II) Hybrid Surveillance
 - ED-143: MOPS TCAS II
 - ED-221: MOPS for TCAS II Hybrid Surveillance
- TCAS and Transponder
 - DO-260B: Corrigendum 1, MOPS for 1090 MHz Extended Squitter Automatic Dependent Surveillance – Broadcast (ADS-B) and Traffic Information Services – Broadcast (TIS-B)
 - ED-102: MOPS 1090MHz ES ADS-B, TIS-B

Global ATM Modernization and Test Equipment

ATC-5000NG Major Customer Benefit - Version 2, DO-260B ADS-B Capability

- The U.S. and the European Mandates specify that ICAO Version 2, RTCA DO-260B shall be the ADS-B Version used.

**DO-260B is not supported on Cobham AvComm
S-1403DL or SDX-2000 legacy test sets.**

- The **ATC-5000NG**, and the **RGS-2000NG** (transponder test mode), provide test capability for Version 2, DO-260B Extended Squitter, hence this capability is a legacy test set replacement driver.



ADS-B UAT (Universal Access Transceiver)

UAT Overview

- UAT is a 978 MHz TDMA (CPFSK) 1.041667 Mbps data link intended to support
 - ADS-B
 - Flight Information Service - Broadcast (FIS-B)
 - Traffic Information Service - Broadcast (TIS-B)
- UAT provides
 - Cheaper installation
 - Reduces congestion on 1090 MHz
 - Deployment in U.S. restricted to use below 18,000 ft
 - Re broadcast on 1090 ES via ADS-R

UAT Media Access Approach

- **Requirement: Simple and Robust logic for aircraft media access**
- **ADS-B transmissions occur based on pseudorandom selection of one of 3200 Message Start Opportunities (MSO)**

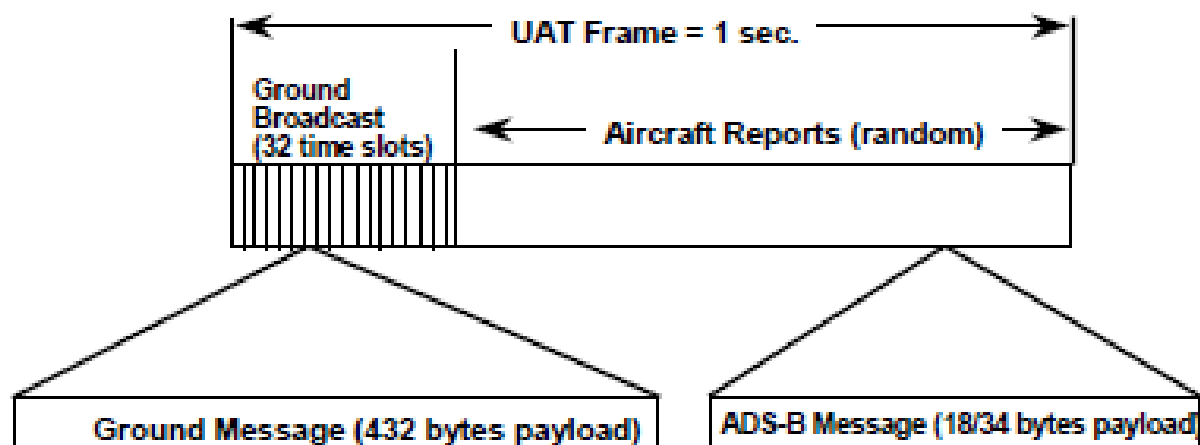

ADS-B Message Format

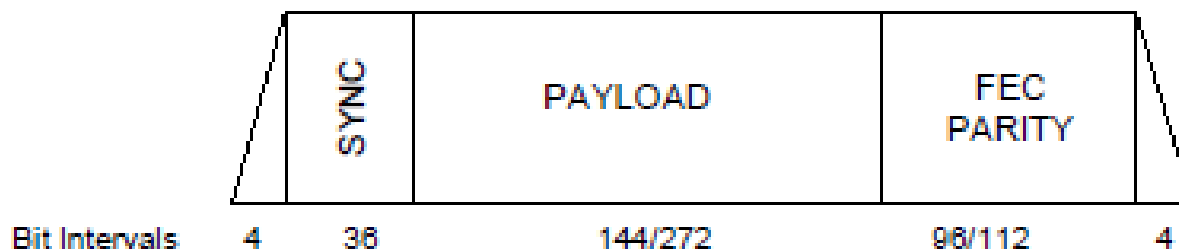

- **Each aircraft transmits exactly one message each second**
- **Standard Forward Error Correction (FEC):**
 - increases message robustness to pulsed interference and noise
 - provides an extremely low undetected message error rate $\sim 10^{-9}$

UAT and 1090ES Operational Envelopes

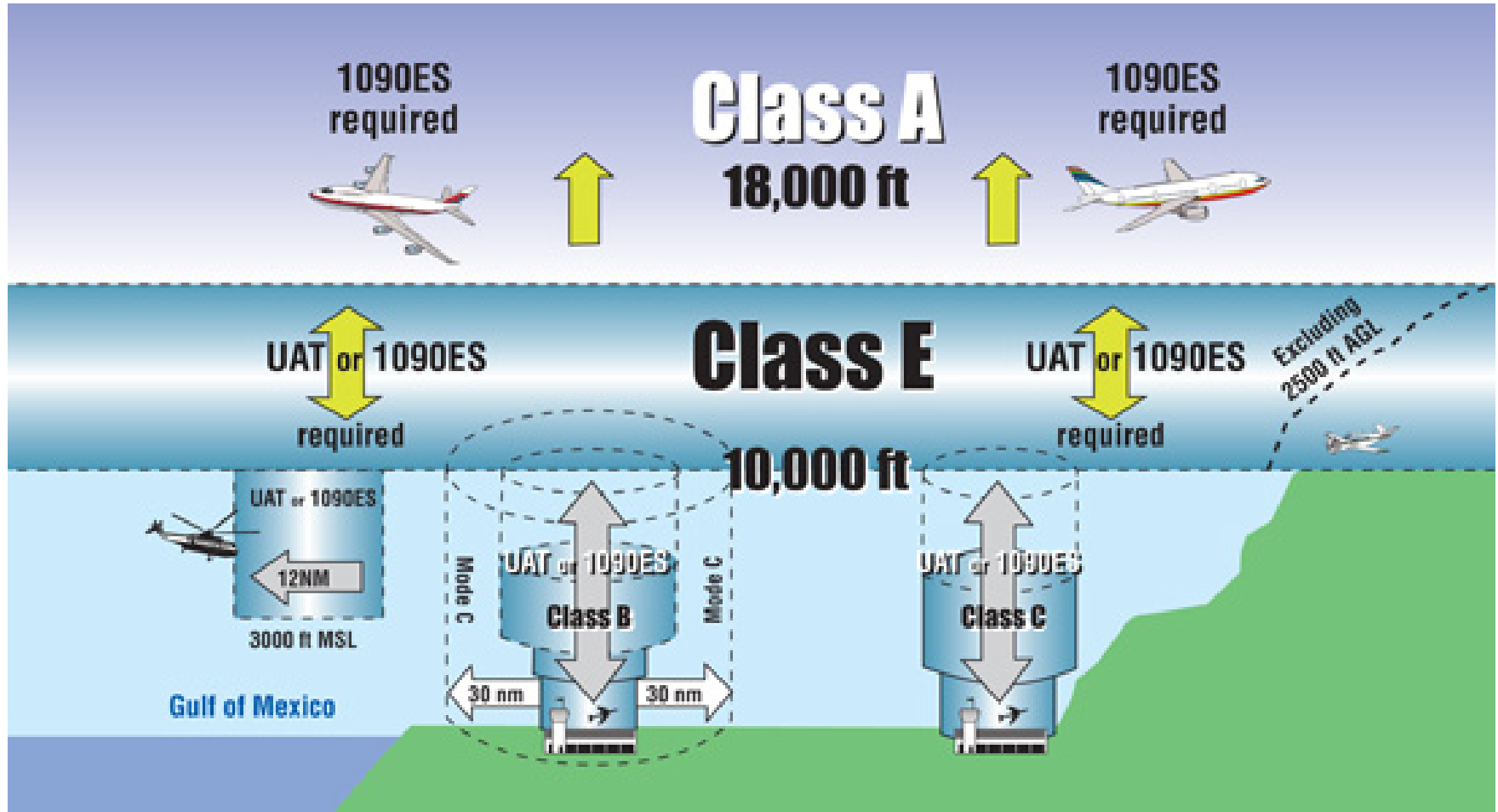

- For the U.S. UAT may be used in aircraft operating below 18,000 ft to meet the ADS-B equipage mandate.

UAT operators/maintainers will need supporting test equipment for UAT bench repair and return-to-service testing. The Cobham AvComm legacy S-1403DL/ATC-1400A & SDX-2000 do not support UAT.

- The **ATC-5000NG**, and the **RGS-2000NG**, provide UAT ADS-B test capability.

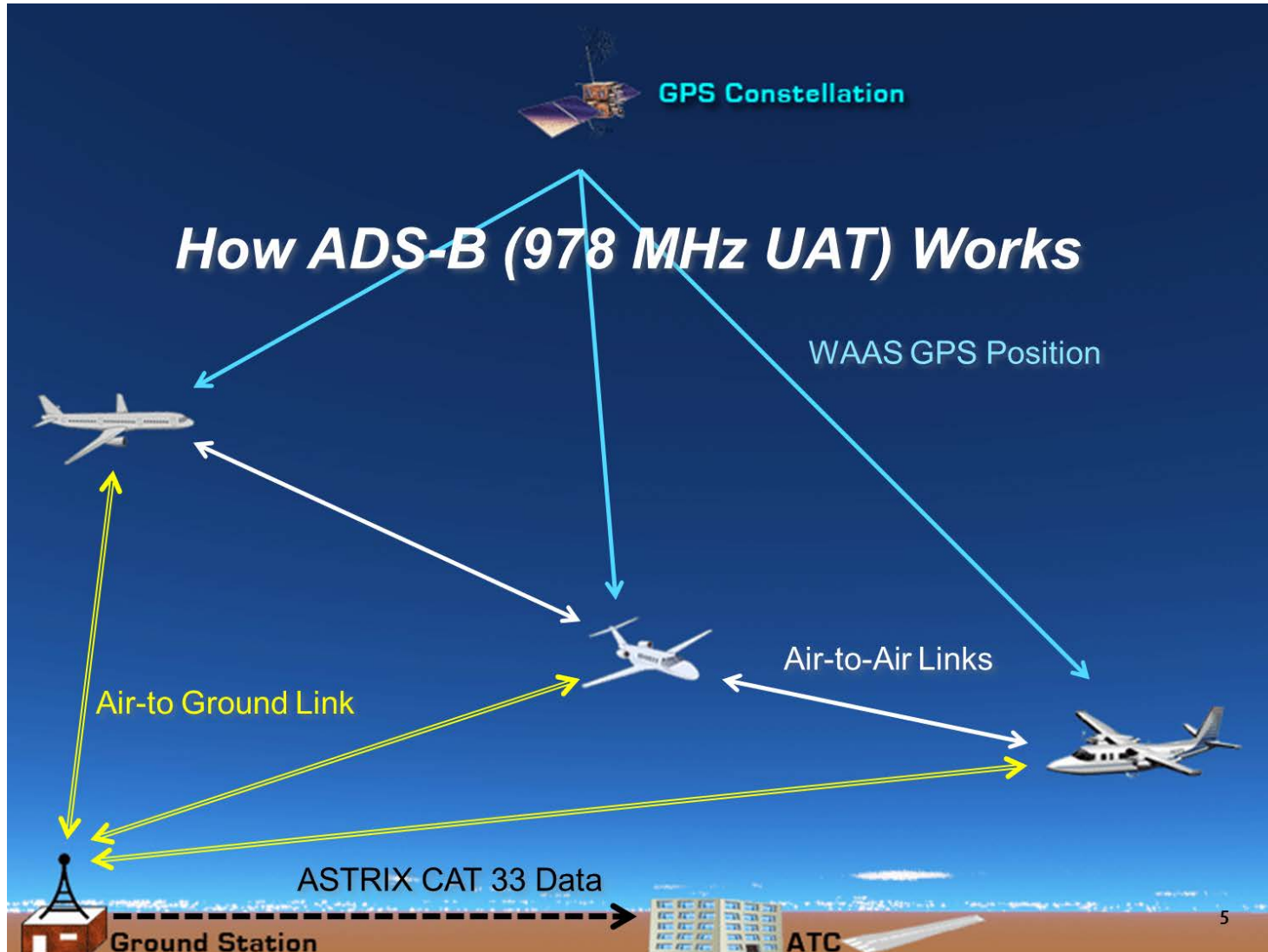

Global ADS-B 1090ES

Terrestrial ADS-B

- ADS-B is considered as an essential component of any future air traffic management system. It is incorporated in the U.S. NextGen (Next-Generation Air Transportation System) as well as in the SESAR [Single European Sky ATM (Air Traffic Management) Research] initiative and will provide enhanced surveillance capabilities.
- Ground based ADS-B stations are increasingly deployed, but the coverage area is limited typically to a few hundreds of kilometers. The following slide shows a map of ADS-B ground station coverage in the U.S. presented as an example.
- An adequate solution for a global surveillance of air traffic movements based on ground based ADS-B appears to be out of scope due to technical, operational and political constraints:
- Oceanic Coverage would implicate the deployment of ADS-B stations on numerous buoys.
- Terrestrial Coverage would implicate the deployment and operation of ADS-B stations in inaccessible terrain.
- The global airspace is fragmented and thus operated by a large number of local ATC providers.
- Political obstacles in particular in unstable regions prevent any trans-national regulation and operation.

Terrestrial ADS-B Coverage



Coverage areas and tower locations are approximate - Current as of 4/15/14

Global (Space) ADS-B

- Only satellites have the capability to provide a global coverage at any possible flight level, avoiding limitations imposed by terrestrial ADS-B. This could be implemented by receiving ADS-B signals, which are broadcasted regularly by each equipped aircraft and which contain information on position, speed, direction etc. by LEO satellites. This data can then be made available to already existing ATC ground infrastructures.
- Therefore, a satellite-based surveillance network will provide enhanced Air Traffic Services in areas where the traffic density, the location, or the cost of “conventional” ATC equipment would not justify any installation of radar and/or terrestrial ADS-B.
- It can also include VHF coverage fringe areas and areas where existing radar is to be decommissioned, and where the replacement costs are not justified.

Global (Space) ADS-B

ADS-B scenario of cross-linked LEO satellite operations in the Iridium NEXT constellation

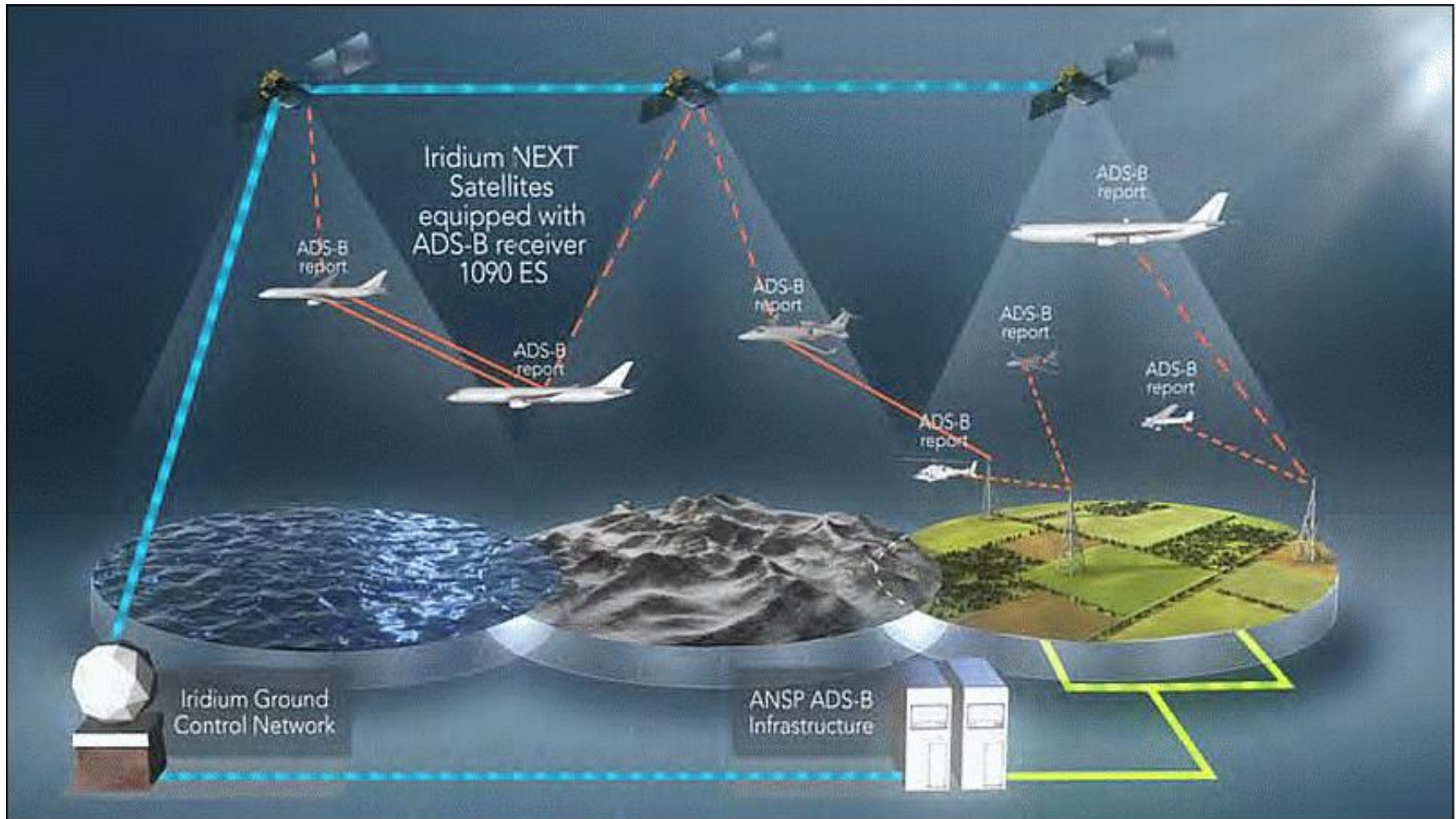

Global ADS-B Surveillance is a “Game Changer” for aviation

- Fits with Next GEN (Next Generation Air Transportation System) / SESAR (Single European Sky ATM Research)
- Significant fuel & GHG (Greenhouse Gas) savings
- Avoids ADS-B ground based replacement or some initial installation costs
- Benefits to domestic traffic can be realized in remote areas or through improved air traffic flow management to and from oceanic
- Public will benefit from safer + more expeditious flights in remote, polar and oceanic airspace worldwide
- Opportunity to boost aviation innovation & the environment globally.

Coverage of ADS-B receivers hosted on the Iridium NEXT constellation

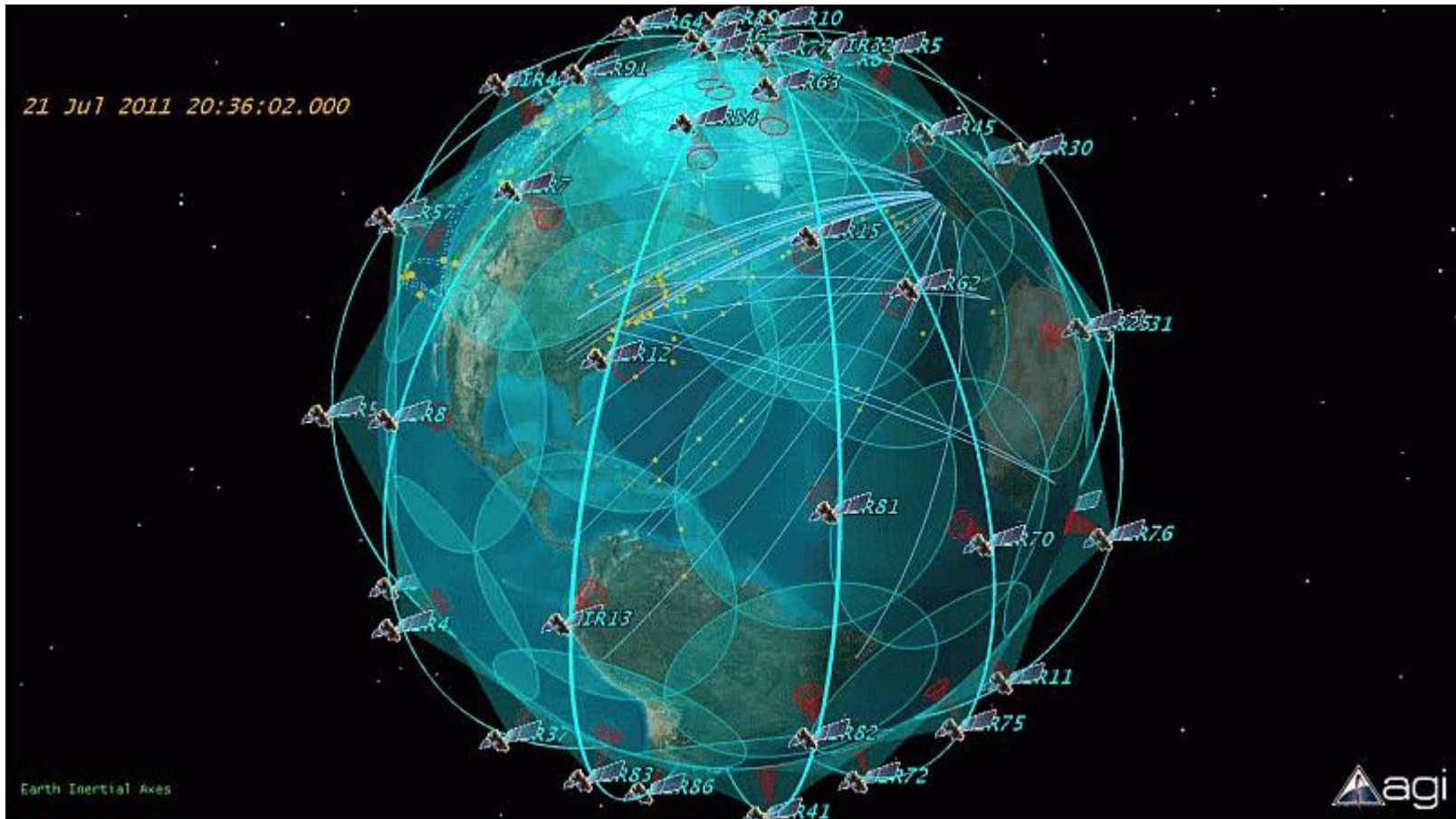

ADS-B Hosted Payload on the Iridium NEXT LEO Constellation

- On the commercial side, Iridium is in the process to introduce ADS-B receivers as hosted payloads on Iridium NEXT, Iridium's next-generation constellation of 66 cross-linked LEO satellites - enabling a global aircraft surveillance service. Iridium Communications Inc. (ICI) is headquartered in Mclean, VA, USA.
- The Iridium NEXT design includes:
 - 66 operational Low Earth Orbiting (LEO) advanced communications satellites
 - 6 in-orbit spare satellites
 - 9 ground spares
 - Back-up gateway and command-and-control facilities.

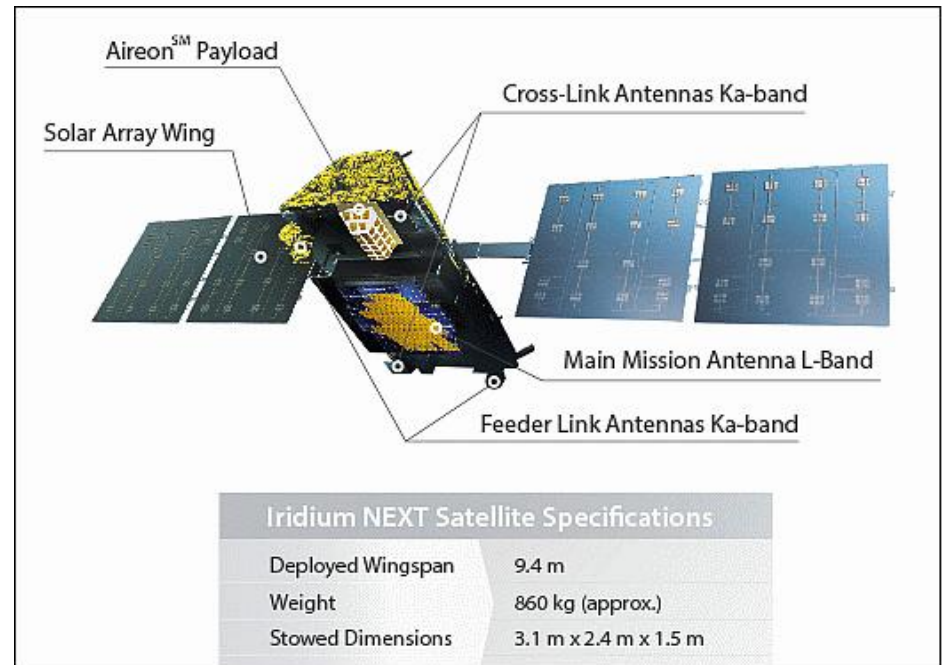

Launch

- Iridium has contracted with SpaceX to launch the Iridium NEXT constellation on Falcon-9v1.1 vehicles in the timeframe 2015-2017.
- Ten satellites are on each launch and seven missions are planned.
- Orbit: Circular polar orbit, altitude = 780 km, inclination = 86.4°, period = 101 minutes (the spacecraft are positioned in 6 orbital planes, each plane containing 11 spacecraft).
- Some of the main players in the Iridium consortium are:
 - Iridium - Owner/operator of satellite constellation
 - Aireon - Joint venture of Iridium and NAV CANADA, created to establish ADS-B service
 - TAS (Thales Alenia Space), builder of satellites, under contract to Iridium
 - Harris Corporation, builder of ADS-B payloads, under contract to Aireon
 - ITT-Exelis, provider of systems engineering support, under contract to Aireon and builder of processing and distribution subsystem.
 - NAV CANADA - Investor in Aireon; launch customer for ADS-B service.

Hybrid Surveillance

TCAS Hybrid Surveillance

- Hybrid surveillance is a method that decreases the number of Mode S surveillance interrogations made by an aircraft's TCAS II unit. This feature, new to TCAS version 7.1, may be included as optional functionality in TCAS II units.
- TCAS II units equipped with hybrid surveillance use passive surveillance instead of active surveillance to track intruders that meet validation criteria and are not projected to be near-term collision threats.
- With active surveillance, TCAS II transmits interrogations to the intruder's transponder and the transponder replies provide range, bearing, and altitude for the intruder. With passive surveillance, position data provided by an on-board navigation source is broadcast from the intruder's Mode S transponder.
- The position data is typically based on GNSS and received on own aircraft by the use of Mode S extended squitter, i.e. 1090 MHz ADS-B, also known as 1090ES. Standards for Hybrid Surveillance have been published in RTCA DO-300.
- The intent of hybrid surveillance is to reduce the TCAS II interrogation rate through the judicious use of validated ADS-B data provided via the Mode S extended squitter without any degradation of the safety and effectiveness of TCAS II.
- Active interrogations are used to track any intruder which is perceived to be a threat.

Global ATM Modernization and Test Equipment

TCAS Hybrid Surveillance

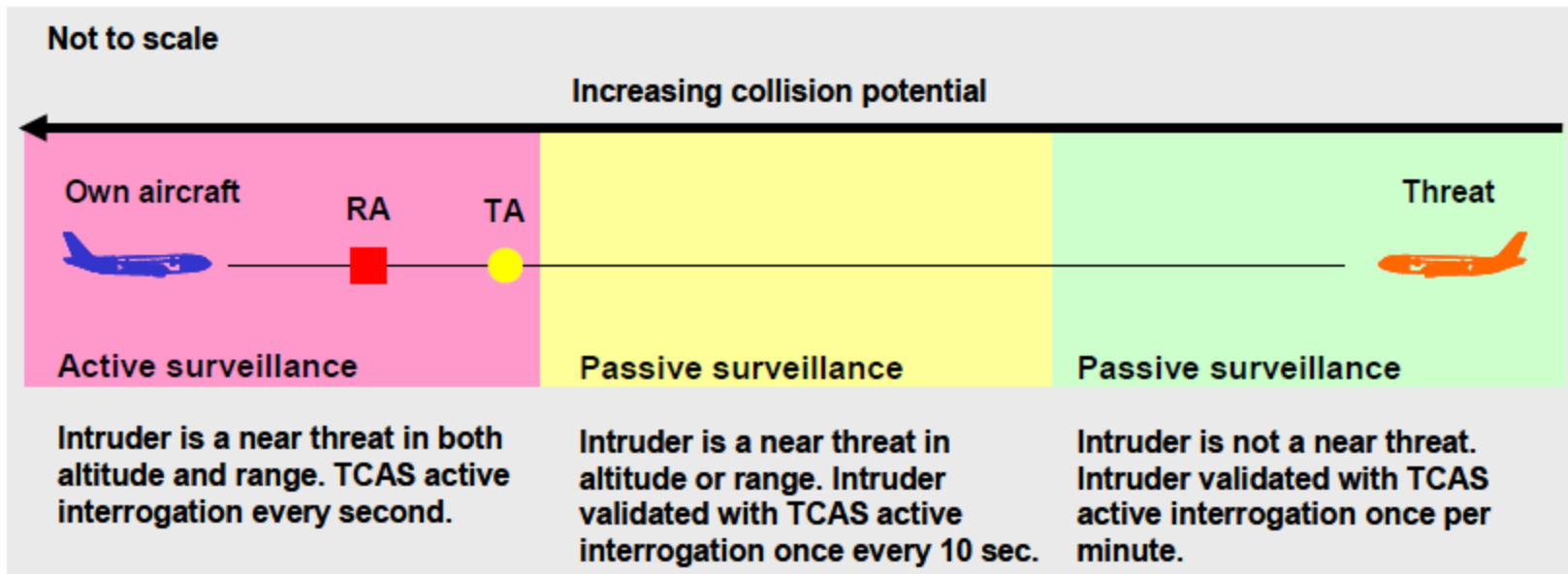

TCAS Hybrid Surveillance

- In the TCAS/ADS-B integrated (Hybrid) surveillance system, the TCAS can get the target's position and velocity information directly broadcasted from the ADS-B without interrogating the transponder, so it can reduce the TCAS interrogating rate, reduce the 1030/1090 occupancy, maintain the independence of collision avoidance of TCAS, and increase the surveillance precision.
 - In the TCAS/ADS-B Passive surveillance area, the target is tracked via ADS-B surveillance and actively interrogated every minute, to validate the ADS-B target position.
 - In the TCAS/ADS-B Passive surveillance area 40nm =>, is tracked via ADS-B surveillance and actively interrogated every 10 seconds to validate the ADS-B target position.
 - In the TCAS Active surveillance area, the target is tracked via interrogations at 1 per second.

Global ATM Modernization and Test Equipment

TCAS Hybrid Surveillance Volume

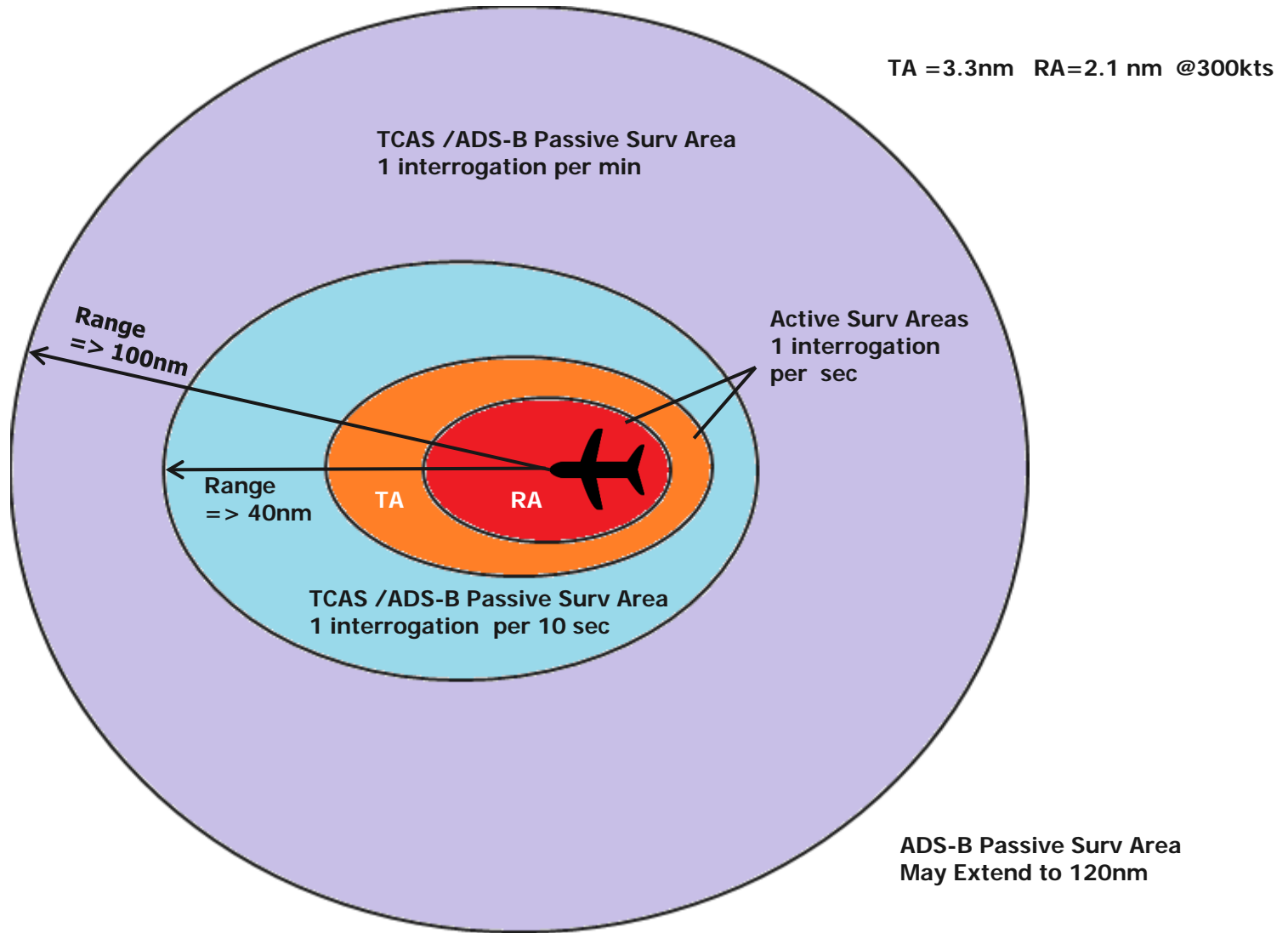

Hybrid TCAS operators/maintainers will need supporting test equipment for bench repair and return-to-service testing. The Cobham AvComm Legacy RGS-2000 does not support Hybrid TCAS.

- The **RGS-2000NG** provides Hybrid TCAS test capability.

Global ATM Modernization and Test Equipment

EUROCAE and RTCA ADS-B Applications

ADS-B OUT



ADS-B OUT:
Capability to
transmit ADS-B data

- ADS-B data provided by transponder
 - Need transponder
- ADS-B OUT capable**



ADS-B IN:
Capability to receive
ADS-B data

- ADS-B data received by TCAS
- Need TCAS ADS-B IN capable

For ground use:

- ADS-B NRA: Non Radar areas
- ADS-B RAD: Radar areas
- ADS-B APT: Airport surfaces

For airborne use:

ATSAW (Air Traffic Situational Awareness)

- Step 2A: ATSAW operation in air
- Step 2B: ATSAW operation on ground

Global ATM Modernization and Test Equipment

ATSAW (Air Traffic Situational Awareness) Display



Global ATM Modernization and Test Equipment

ATSAW (Air Traffic Situational Awareness) Display Symbology (Airbus)

	Other	Proximate	TA	RA
TCAS Only				
ADS-B Only				
TCAS + ADS-B				

Global ATM Modernization and Test Equipment

ATSAW VSA (Visual Separation on Approach) Display



Visual Separation on Approach

- Easier for flight crews to acquire and then to maintain own visual contact with the preceding aircraft.
- Flight crews maintain a more precise distance from the preceding aircraft (anticipating speed change).
- Potential runway capacity improvements in Visual Meteorological Condition (VMC) and Alternate VMC

Global ATM Modernization and Test Equipment

ATSAW SURF (Surface) Display

MOVING MAP

(given by On-board Airport Navigation System)



MOVING MAP + TRAFFIC INFORMATION

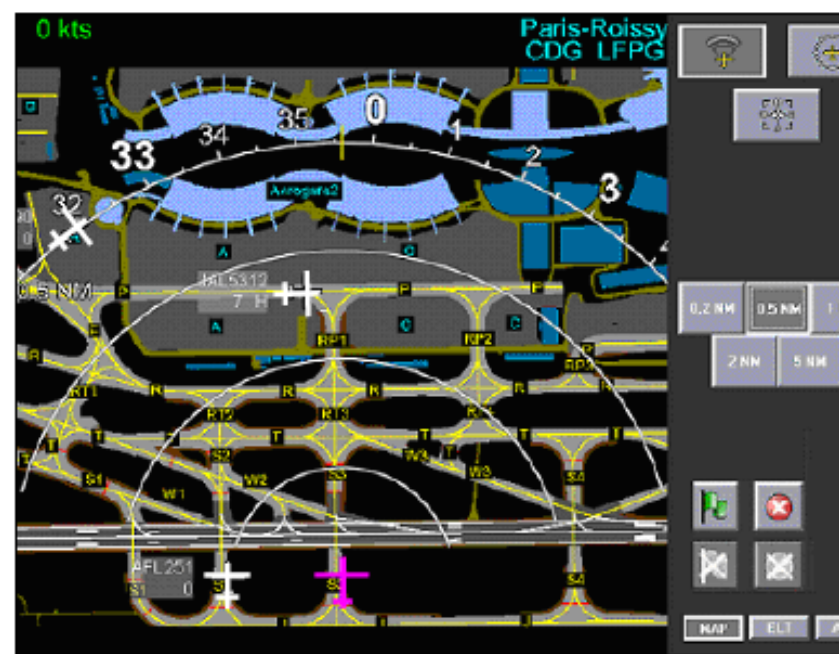

On Airport Surface

- Computes potential conflict with ADS-B OUT equipped aircraft
- Provides the crew with indication & alerts in case of potential conflict

Global ATM Modernization and Test Equipment

ATSAW ITP (In Trail Procedure) Displays



In-Trail Procedure

- Enhanced efficiency
- Reduced Longitudinal separation of 15 NM will be sufficient for a flight level change (compared to 80 NM today)
- Significant fuel saving due to optimum flight level
- Enhanced safety, Better awareness of traffic situation during flight level change procedure.

Wide Area Multilateration

POSITIONING METHOD: *MULTILATERATION*

- ✘ **Multilateration**, also known as **hyperbolic positioning**, is the process of locating an object by accurately computing the **time difference of arrival (TDoA)** of a signal emitted from the object to three or more receivers.

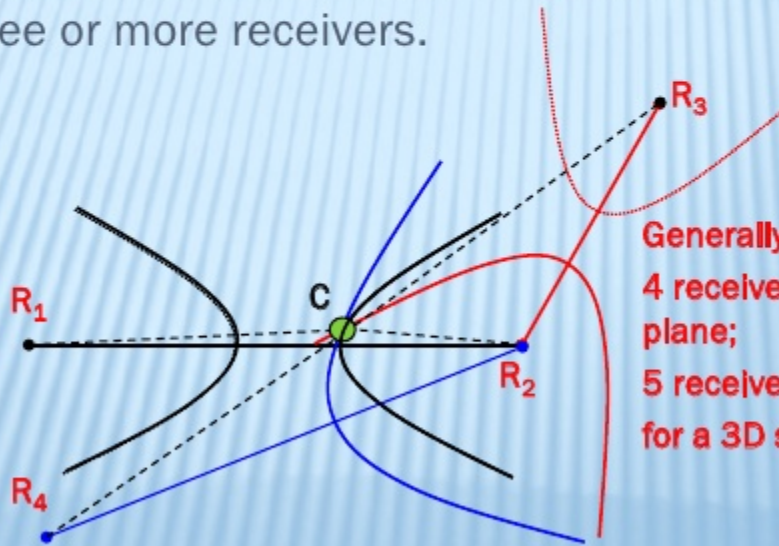

Generally
4 receivers are needed for a 2D plane;
5 receivers are needed for a 3D space.

WAM (Wide Area Multilateration)

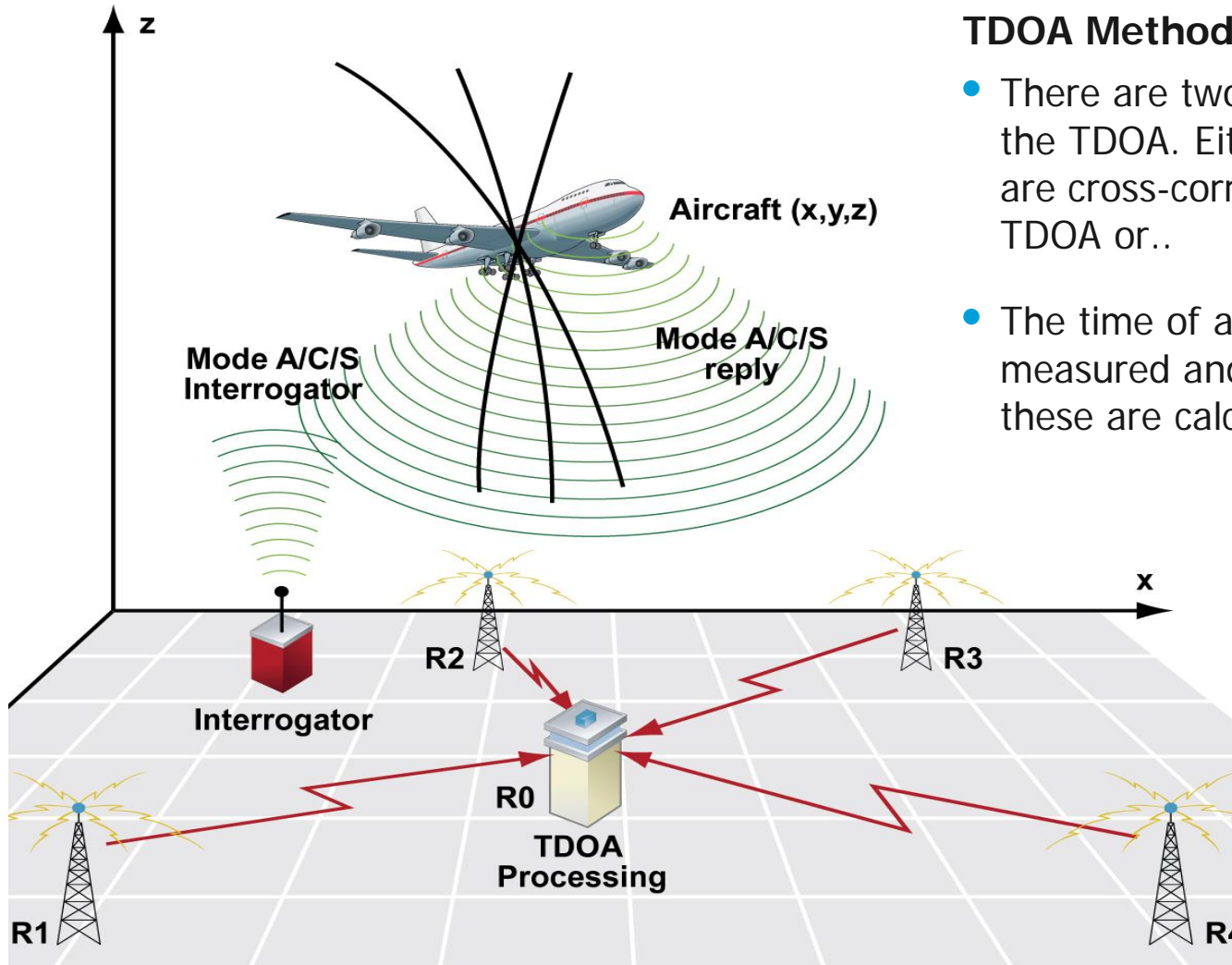

TDOA Methods

- There are two methods of calculating the TDOA. Either the signals received are cross-correlated to produce a TDOA or..
- The time of arrival (TOA) is measured and the time differences of these are calculated.

WAM TOA

TOA systems are typically used with signal waveforms where it is easy to measure a defined pulse edge such as with aircraft SSR transponder signals. Cross-correlation can be used with any signal but the suitability depends on the auto correlation properties of the signal. The TOA method is the most common method for SSR multilateration.

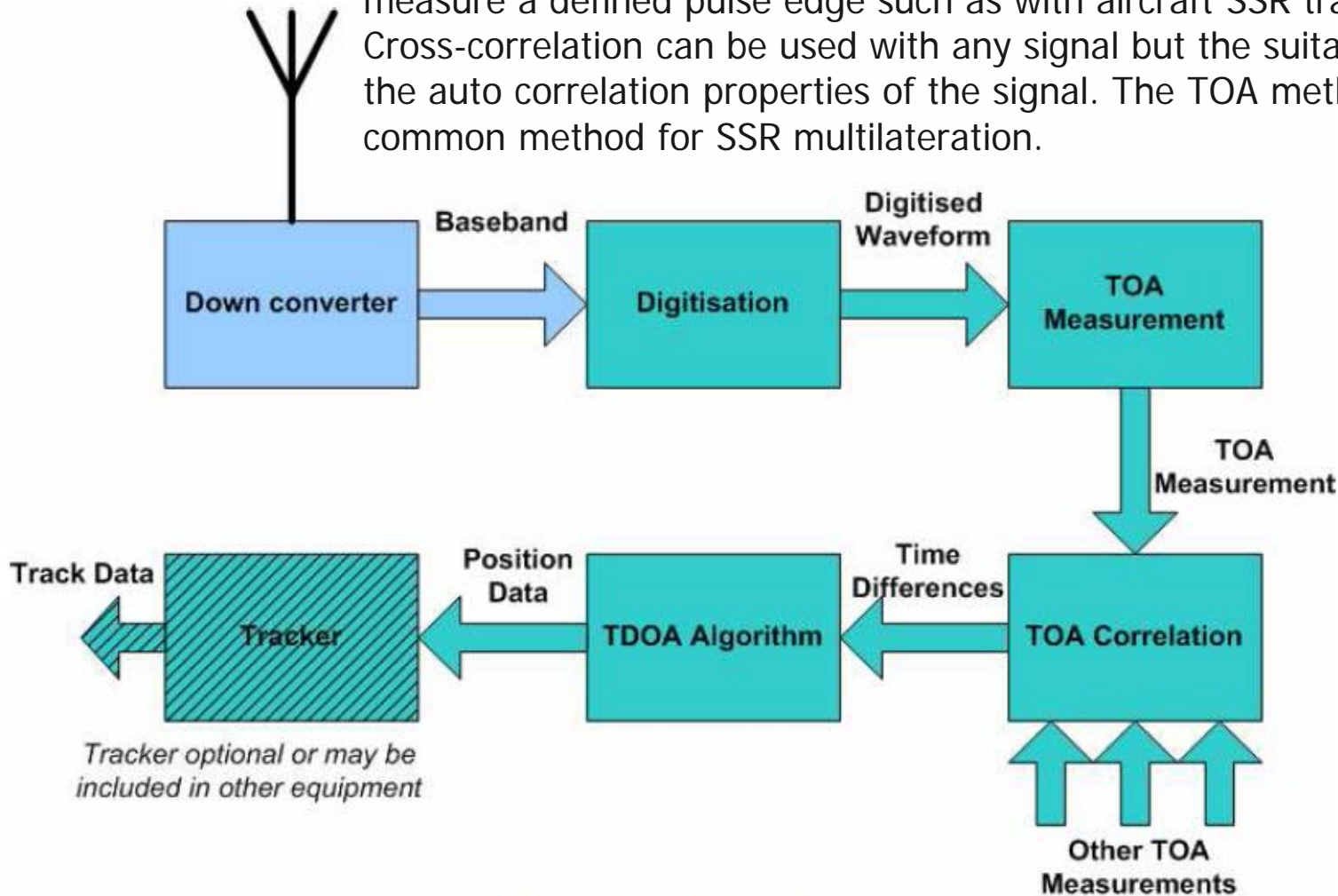

WAM Cross Correlation

Cross Correlation Systems

Cross-correlation is commonly used in military Electronic Surveillance Measure (ESM) systems and in systems that locate a cell phone during an emergency call. The diagram shows the simplified data flow in a cross-correlation system.

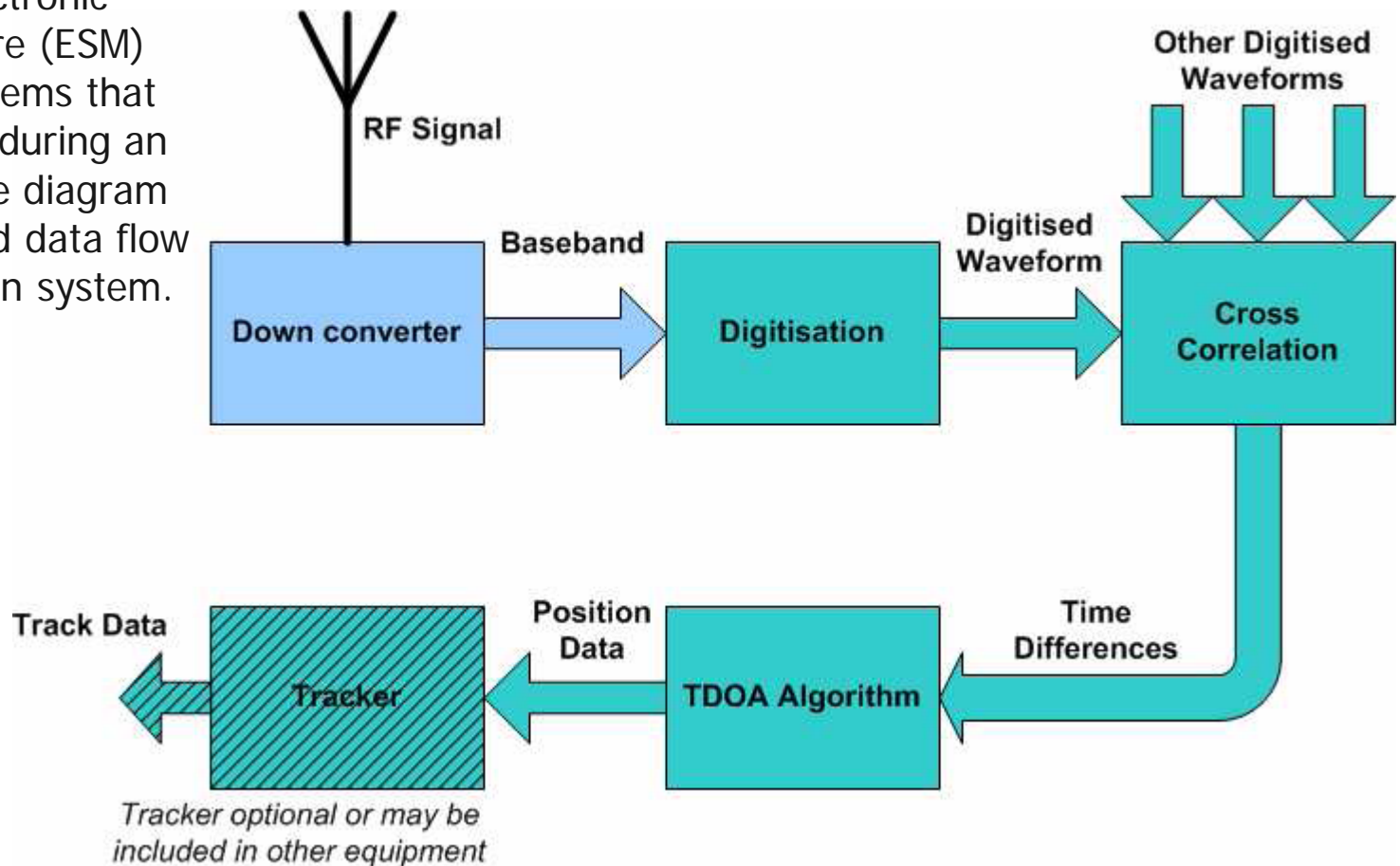

WAM (Wide Area Multilateration) Formats

Format	DF	Type of Information
Mode A		Identity
Mode C		Altitude
Mode S acquisition squitter	11	Technical address
Mode S extended squitter	17	Technical address, Identity, Altitude, ADS-B
Mode S short ACAS	0	Technical address, Altitude
Mode S long ACAS	16	Technical address, Altitude, air-air coordination
Mode S short surveillance	4, 5	Technical address, Identity, Altitude
Mode S long surveillance	20, 21	Technical address, Identity, Altitude, Data Link

New Test Equipment to Support ATM Modernization

RGS-2000NG TCAS Tester

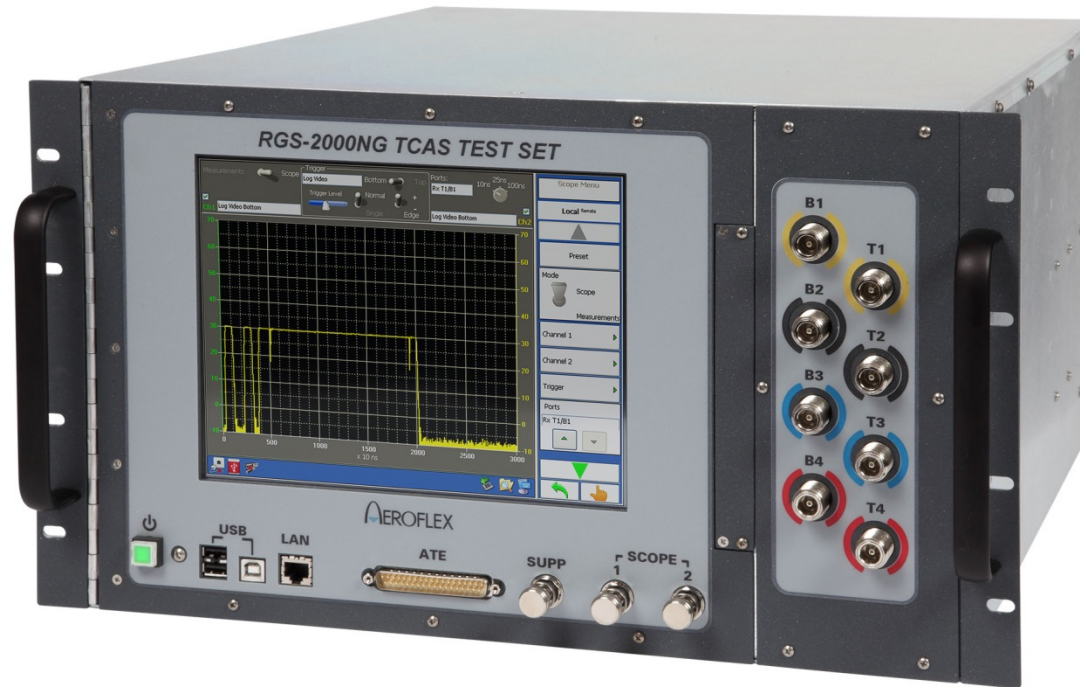

The New RGS-2000NG

- **The New RGS-2000NG launched by Cobham in Q1, 2015**
 - RF signal generator/receiver for testing TCAS LRUs
 - State of the art software defined radio design (field upgradeable)
 - Replacement for legacy RGS-2000
 - For engineering development, design validation, manufacturing and return-to-service testing.
 - Command set emulation of the legacy RGS-2000 (as well as native SCPI commands)
 - Design driven by FAA's NextGen requirements
 - To support testing for the RTCA DO-185B, DO-181E, DO-260B and DO-300
 - Simulates ADS-B targets (simultaneously with TCAS operation)
 - Modern architecture makes it capable of handling future requirements
 - Transponder option available

Global ATM Modernization and Test Equipment

RGS-2000NG Highlights

- **RGS-2000NG Product Description and Highlights (continued):**
 - 10.4 inch touch screen LCD display for operator control of all test set capabilities
 - Can be remotely controlled via GPIB or ethernet
 - Simulates 32 dynamic/568 static intruders
 - ADS-B squitter encode/decode
 - Four port antenna simulation
 - Six independent transmitters and two receivers
 - Data parsing for analysis
 - Pulse and frequency measurement
 - Lightweight: RGS-2000NG ~44 lbs vs. RGS-2000 ~126 lbs (ships better)

Comparison Legacy/Next Generation

	RGS2000	RGS2000NG
• Display type	EL with keypad	LCD with touch
• Control interface for ATE applications	GPIB	GPIB, Ethernet
• Pulses programmable for width, position and amplitude	√	√
• Mode S, A and C targets	DO-181	DO-181E
• Number of unique targets programmable	30 dyn 120 static	32 dyn 568 static
• Supports all uplink/downlink protocols	No	DO-181E
• Extended squitter testing	No	DO-181E
• ADS-B, ADS-R, TIS-B target simulation	No	DO-260B
• Independent RF channels for scenario simulation	3	6
• RF output range	-20 to -85dBm	-20 to -90dBm
• RF output accuracy	+/-1 dB	+/-1 dB*
• On/Off ratio	>60 dB	>80 dB
• Configuration storage capability	No	Yes

- **Intruder Capability**
 - Simulates 32 dynamic/568 static intruders
- **Intruder Types**
 - Mode S TCAS only (no ADS-B)
 - Mode C
 - Mode S with ES (ADS-B)
 - ADS-B
 - ADS-R
 - TIS-B
- **DO-260B Special Tests (for ES)**
 - Normal
 - Altered Preamble (width, position, Gen A or B, On/Off)
 - Bit Failures
 - Overlapping Pulses
 - Preamble Validation
 - Confidence Test

- **Block Transmission**

- Block of 1090/1030 messages to transmit for FRUIT and garbling simulation
- Each message start time can be set relative to a trigger
- Each message amplitude can be set
- 1000 Messages
- 1 to 50,000 blocks
- Messages can be transmitted at a specific bearing

- **Message Types**

- Mode S Interrogation
- Mode S Reply
- ATCRBS Interrogation
- ATCRBS Replies

ATC-5000NG Transponder/UAT Test Set

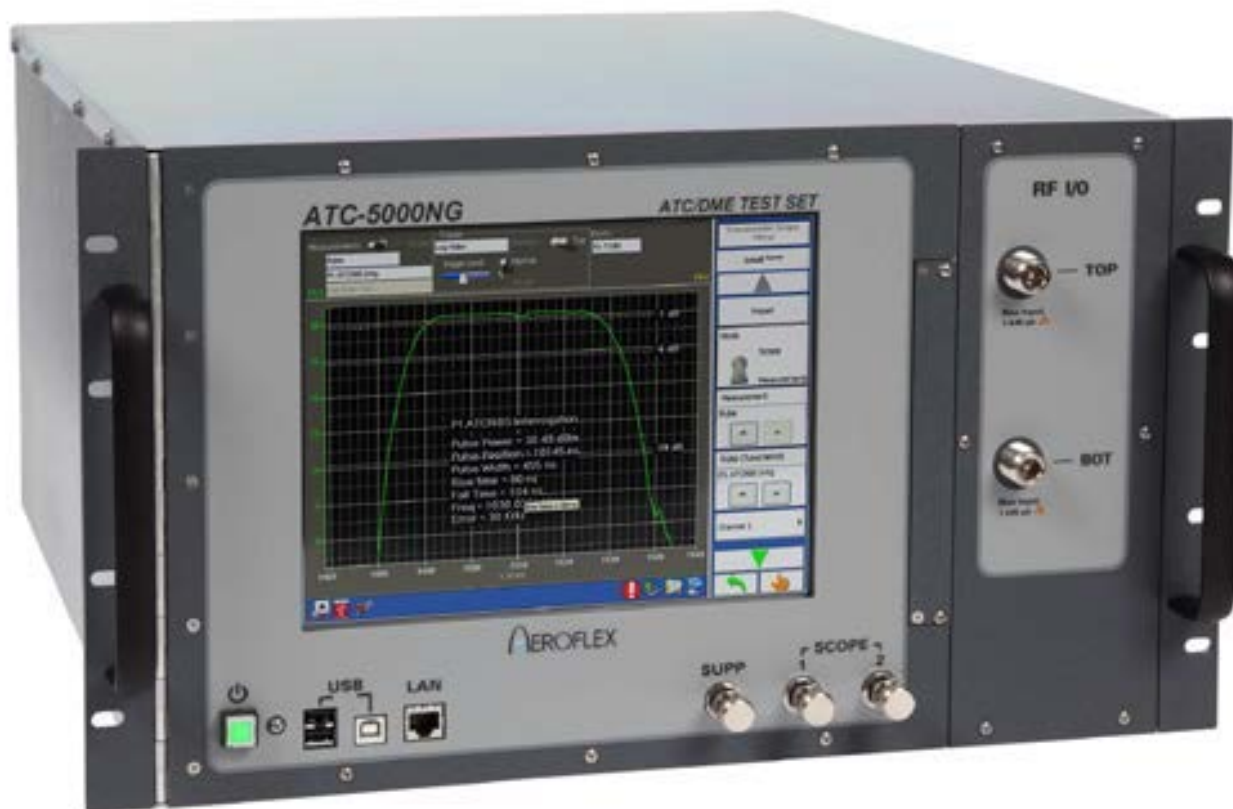

The ATC-5000NG

ATC-5000NG

- Transponder Test Set is an RF signal generator/receiver for testing Mode A, C and S transponders
- Designed with modern software defined radio technology
- Replacement for the SDX-2000, ATC-1400A and S-1403DL for engineering development, design validation, manufacturing and return-to-service testing
- Can be remotely controlled via GPIB or ethernet
- ADS-B squitter encode/decode
- DO-260, DO-260A and DO-260B data parsing
- TX/RX data logging capability
- Full diversity testing capability
- Pulse and frequency measurement
- UAT TX/RX capability (option)

- **DO-260B Special Tests (for ES)**

- Normal
- Altered Preamble (width, position, Gen A or B, On/Off)
- Bit Failures
- Overlapping Pulses
- Preamble Validation
- Confidence Test

- **Target Types**

- Mode C
- Mode S
- ADS-B
- ADS-R
- TIS-B

- **Block Transmission**

- Block of 1090/1030 messages to transmit with a specific timing and at a specified periodic timing for FRUIT and garbling simulations
- 1000 Messages
- 1 to 50,000 blocks

- **Message Types**

- Mode S Interrogation
- Mode S Reply
- ATCRBS Interrogation
- ATCRBS Replies

- **Interrogation Table**

- 2000 Interrogations
- ATCRBS
- Modes S
- Any single interrogation can have a sync set to display related reply
- Any single interrogation can have a specific amplitude

- **Single Interrogation Mode**

- Mode A
- Mode C
- Mode A All-Call
- Mode C All-Call
- Mode A/Mode S All-Call
- Mode C/Mode S All-Call
- Mode S
- P1-P2
- Pulse,
- DME pulse pair
- Alternating Mode A/C

- **Double Interrogation/Interference Pulse**

- Mode A
- Mode C
- Mode A All-Call
- Mode C All-Call
- Mode A/Mode S All-Call
- Mode C/Mode S All-Call
- Mode S
- P1-P2
- Pulse (Interference)
- DME pulse pair
- Alternating Mode A/C

Global ATM Modernization and Test Equipment



Comparison Legacy/Next Generation

	SDX-2000	ATC-5000NG
• Color LCD display with touch screen interface	√	√
• Control interface for ATE applications	GPIB	GPIB, Ethernet
• Pulses programmable for width, position and amplitude	√	√
• Mode S, A and C interrogations	DO-181B	DO-181E
• Number of unique interrogations programmable	32	1000 <small>addl blocks available</small>
• Supports all uplink/downlink protocols	DO-181B	DO-181E
• Extended squitter testing	DO-260A	DO-260B
• Two independent RF channels for diversity testing	2	6
• RF output range	0 to -110 dBm	+1 to -110dBm
• RF output accuracy	+/- .5 dB	1 dB*
• On/Off ratio	>80 dB	>80 dB

* Present specification subject to change.

Comparison Legacy/Next Generation

ATC-1400A/S1403DL

ATC-5000NG

• Color LCD display with touch screen interface	Hybrid Controls	√
• Control interface for ATE applications	GPIO	GPIO, Ethernet
• Pulses programmable for width, position and amplitude	√	√
• Mode S, A and C interrogations	DO-181B	DO-181E
• Number of unique interrogations programmable	1000 <small>Mode S Only</small>	1000 <small>addl blocks available</small>
• Supports all uplink/downlink protocols	DO-181B	DO-181E
• Extended squitter testing	DO-260	DO-260B
• Two independent RF channels for diversity testing	2	6
• RF output range	Note 1	+1 to -110dBm
• RF output accuracy	Note 2	1 dB*
• On/Off ratio	>80 dB	>80 dB

Note 1: ATC-1400A Range 0 to -127 dBm S-1403DL Range 20 to -83 dBm

Note 2: ATC-1400A Accuracy 0 to 90dBm +/-2.0dB S-1403DL Accuracy worst case +/-0.72 dBm

* Present specification subject to change.

MOPS Test Support

TCAS MOPS Test Support				
		Legacy ATC	NextGen	
Product	DO-185A	DO-185B	DO-260, A, B	DO-300
RGS-2000	√			
RGS-2000NG	√	√	√	√
Mode S Transponder MOPS Test Support				
	Legacy ATC	NextGen		
Product	DO-181, A, B	DO-181E	DO-260, A, B	DO-282B
SDX-2000	~√			
ATC-1400A/S-1403DL	~√			
ATC-5000NG	√	√	√	√

Note: MOP's certification testing will require additional equipment for some tests (i.e. spectrum analyzer tests such as spectral purity and DO-181E tests that require a 3rd RF source, etc.)